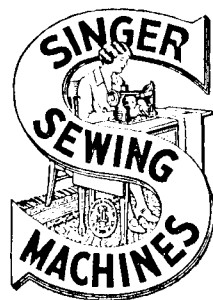


SINGER
107W12

LIST OF PARTS



MACHINE No. 107w12

THE SINGER MANUFACTURING COMPANY

INDEX

	PAGE
ACCESSORIES	18
BOBBIN WINDER	18
KNEE LIFTER	19
MACHINE No. 107w12	7
NUMERICAL LIST OF PARTS	21

Instructions for Ordering

In ordering from this list, use **ONLY** the **PART** number in the **FIRST** column.

The number stamped on a Sewing Machine Part is the number of the Single Part only, except when the part includes Set Screws, Clamping Screws, Studs and Rollers Spun on, Small Wires riveted, or Parts soldered together, etc., which it is necessary to furnish in combination.

Every combination of parts sent out has its specific number which, although not stamped on Parts (except in above case), must be used when ordering the combination.

Each number always indicates the **SAME PART** in whatever list it appears, or for whatever Machine.

The letters after some of the numbers indicate the style of finish only, as follows:

- A. Hardened, Polished and Plated.
- B. Polished and Plated.
- C. Hardened only.
- D. Polished only.
- E. Soft, not polished.
- F. Hardened and Polished.
- H. Blued.
- J. Nickel Plated only
- R. Merlized.
- Y. Black Nickel Plated only.

These letters **MUST BE USED** when they appear in the list and **AFTER** the number, as in the list.

In this series

200001 to 201500 and 350001 to 351500 are Screw Numbers.

201501 to 201800 and 351501 to 351800 are Nut Numbers.

201801 to 202000 and 350801 to 352000 are Roller Numbers.

202001 to 350000 are Numbers of Machine Parts.

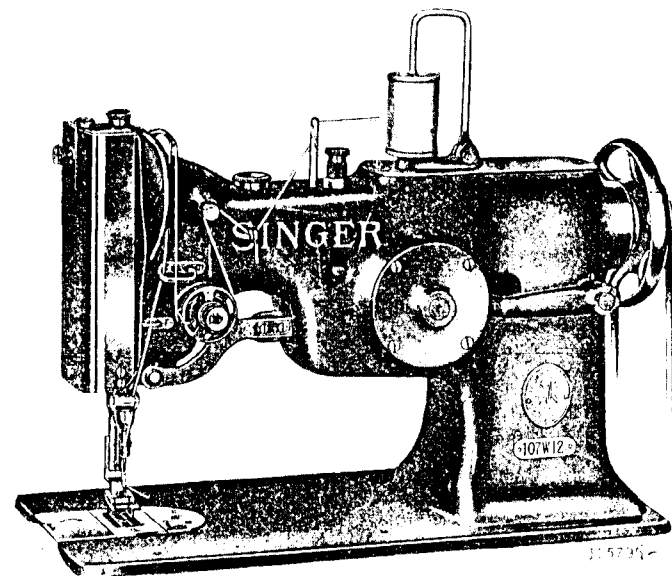
The figures in the second column refer only to the plate in which the illustration of the part is shown and are **NOT TO BE USED** in ordering.

Two or more numbers over a cut indicate that the difference between such parts is not visible in an illustration.

Parts marked with an asterisk (*) are furnished only when repairs are made at the factory.

LIST OF PARTS COMPLETE

FOR



MACHINE No. 107w12

For Stitching Leather Sweat Bands to Soft Caps and Cloth Hats with Ornamental Stitch. Needle throws up to $\frac{3}{8}$ inch and may be adjusted to vibrate either to the right or left of the center of needle hole

No.	Plate	Name
*235201	---	Arm
203087	10751	" Cap
200278n	10755	" " Screw
202248	10755	" " Washer
203089	10751	" " Spool Holder Base
203090	-----	" " " " " 203089 with 200079n and 204296
200585nr	13197	Arm Cap Spool Holder Base Screw
204296	10751	" " " " Wire
200079n	13197	" " " " " Hinge Screw

Parts for Machine No. 107w12

No.	Plate	Name
203088	10751	Arm Cap and Spool Holder complete, Nos. 203087, 203090 and two 200585r
204235	10755	Arm Position Pin (2)
200010E	10755	" Screw (3)
202005	15292	" " Washer (3)
202249	15293	" Shaft with 200357E and 224392
202243	15293	" " Bushing (back) with 202244
202244	---	Arm Shaft Bushing (back) Oil Packing (wick)
200338C	10755	Arm Shaft Bushing (back) Set Screw
207080	15293	Arm Shaft Bushing (front) with 202244
202244	---	Arm Shaft Bushing (front) Oil Packing (wick)
200502B	10755	Arm Shaft Bushing (front) Oil Packing Thumb Screw
200341C	10755	Arm Shaft Bushing (front) Set Screw
210503	15293	Arm Shaft Connection Belt
202635	---	" " " " Pulley with 200327C, 200602E and two 202253
200602E	10755	Arm Shaft Connection Belt Pulley Position Screw
200327C	10755	Arm Shaft Connection Belt Pulley Set Screw
202253	10757	Arm Shaft Connection Belt Pulley Spring Flange
224392	---	Arm Shaft Oil Packing (wick)
200357E	10755	" " " " Stop Screw
202255	10752	Balance Wheel (belt groove 2 1/4 in. diam.) with 200328C and 200335C
200328C	10755	Balance Wheel Position Screw
200335C	10755	" " Set Screw
*210504	---	Bed
202258	10751	" Hinge Connection (2)
200570E	10755	" " " Screw (4)
210505	10751	" Plate (back)
200577H	10755	" " " Screw (2)
210616	10751	" Slide (front)
210530	13174	Bobbin
210846	10736	" Case Base
210729	10736	" " Cap with 200592C, 201016F and 210845

Parts for Machine No. 107w12

No.	Plate	Name
210915	10736	Bobbin Case Cap complete, Nos. 200964E, 210729, 210736 and 210914
210913	10736	Bobbin Case Latch
210914	---	" " " 210913 with 210734 and 210735
210735	13197	Bobbin Case Latch Fulcrum Pin
210734	13197	" " " Lever
210736	13197	" " " Spring
200964E	13197	" " " Stop Screw
210764	13197	" " Stop
200076D	14158	" " " Screw
210845	13197	" " Tension Spring
201016F	10736	" " " " Regulat- ing Screw
200592C	13197	Bobbin Case Tension Spring Screw
210847	10736	Bobbin Case complete, Nos. 210846 and 210915
210381	10751	Face Plate
202135	10755	" " Position Pin
200462B	10755	" " Thumb Screw
210682	---	Face Plate complete, Nos. 210681, 210684 and two 200137u
210512	15293	Feed Bar
210513	---	" " 210512 with 200641C, 201522E and 202623
200641C	10755	Feed Bar Hinge Screw (driving)
201522E	13197	" " " " Nut
202276	10760	" " Slide Block
210514	10760	" " " " Crank with 200035E
210515	10760	Feed Bar Slide Block Crank 210514 with 200253D, 201531E and 202276
200035E	10760	Feed Bar Slide Block Crank Pinch Screw
200253D	10736	Feed Bar Slide Block Hinge Screw
201531E	10760	" " " " " " Nut
242018	14156	Feed Dog
200106E	10755	" " Screw (2)
202297	10752	" Driving Connection with 200054E and 202277
202624	10760	Feed Driving Connection Crank with 200038C
200038C	10760	Feed Driving Connection Crank Pinch Screw
200545C	10760	Feed Driving Connection Hinge Screw
201518E	10755	Feed Driving Connection Hinge Screw Nut

Parts for Machine No. 107w12

No.	Plate	Name
202277	---	Feed Driving Connection Oil Packing (wick)
200054E	10755	Feed Driving Connection Pinch Screw
210559	15292	Feed Driving Connection Stop Collar with two 200378c
200378c	10760	Feed Driving Connection Stop Collar Set Screw
202300	15293	Feed Driving Eccentric Regulating Bracket
203098	---	Feed Driving Eccentric Regulating Bracket 202300 with 202635, two each 201014c and 201525E
201014c	13197	Feed Driving Eccentric Regulating Bracket Hinge Screw
201525E	10755	Feed Driving Eccentric Regulating Bracket Hinge Screw Nut
202301	15292	Feed Driving Eccentric Regulating Bracket Plunger
202595	10755	Feed Driving Eccentric Regulating Bracket Plunger Spring
200607c	10755	Feed Driving Eccentric Regulating Bracket Plunger Spring Stop Screw
201014c	13197	Feed Driving Eccentric Regulating Bracket Stop Screw
201525E	10755	Feed Driving Eccentric Regulating Bracket Stop Screw Nut
200429c	10755	Feed Driving Eccentric Regulating Screw
200383c	10755	Feed Driving Eccentric Regulating Screw Check Screw
202623	10752	Feed Driving Rock Shaft
202625	10760	" " " " Stop Collar with two 200383c (2)
200383c	10755	Feed Driving Rock Shaft Stop Collar Set Screw
235202	15293	Feed Lifting Cam with 200327c and 201470c
200327c	10755	Feed Lifting Cam Set Screw
201470c	14158	" " " " "
235203	15293	" " Connection
*210645	---	" " " Crank
210589	10760	" " " " 210645 with 200050c and 200378c
200050c	10760	Feed Lifting Connection Crank Pinch Screw

Parts for Machine No. 107w12

No.	Plate	Name
200378c	10760	Feed Lifting Connection Crank Set Screw
200545c	10760	Feed Lifting Connection Hinge Screw (lower)
201518E	10755	Feed Lifting Connection Hinge Screw (lower) Nut
200545c	10760	Feed Lifting Connection Hinge Screw (upper)
200386c	14158	Feed Lifting Connection Hinge Screw (upper) Set Screw
204479	14158	Feed Lifting Connection Hinge Screw (upper) Set Screw Packing (brass)
235204	15293	Feed Lifting Connection Lever with 200386c and 235205
201822	14158	Feed Lifting Connection Lever Roller
235205	14158	Feed Lifting Connection Lever Roller Stud
235206	15295	Feed Lifting Connection Lever Shaft
235207	---	Feed Lifting Connection Lever Shaft 235206 with 201822, 205508 and 235204
203244	14158	Feed Lifting Connection Lever Shaft Collar with two 200393c ..
200393c	14158	Feed Lifting Connection Lever Shaft Collar Set Screw
205508	14158	Feed Lifting Connection Lever Shaft Position Pin
210531	10752	Feed Lifting Rock Shaft (hollow) and Hook Driving Shaft Bearing
202625	10760	Feed Lifting Rock Shaft Stop Collar with two 200383c
200383c	10755	Feed Lifting Rock Shaft Stop Collar Set Screw
202310	15295	Feed Regulating Spindle with 202311, 202443 and 202619
*202311	---	Feed Regulating Spindle Head
202443	14158	" " " " Pin
202619	15292	" " " " Position Pin
*210532	---	Hook (sewing)
210533	13197	" 210532 with 200145c, 203101, 210536, 210541 and three 200596F
210775	13197	Hook and Bobbin Case complete, Nos. 210533 and 210847
210614	10757	Hook Driving Bevel Pinion (steel), 24 teeth, with two 200378c

Parts for Machine No. 107w12

No.	Plate	Name
200378c	10760	Hook Driving Bevel Pinion Set Screw
210535	10752	Hook Driving Bevel Pinion Shaft
202661	15295	" " " " "
		Belt Pulley with 202324 and two 200378c
200378c	10760	Hook Driving Bevel Pinion Shaft Belt Pulley Set Screw
202324	10757	Hook Driving Bevel Pinion Shaft Belt Pulley Spring Flange
210536	13174	Hook Gib
200596f	15292	" " Screw
203101	-----	" Oil Wick
200915f	10757	" Position Screw
210537	10757	" Shaft (hollow)
210615	10757	" " Bevel Gear (steel), 24 teeth, with two 200382c
200382c	13197	Hook Shaft Bevel Gear Set Screw
210539	10757	" " Bushing
210621	-----	" " " 210539 with 200931f and 210537
200335c	10755	Hook Shaft Bushing Set Screw ...
200363c	10736	" " " " " "
202355	15292	" " " " " Pack- ing (brass)
200931f	10757	Hook Shaft Position Screw
210541	13174	" Washer Needle Guard
200145c	13174	" " " " Screw ..
237837	15295	Knee Lifter Connection Lever
210876	-----	" " " " 237837 with 202447, 210875 and two 200262u
200262u	15292	Knee Lifter Connection Lever Hinge Screw
202447	15295	Knee Lifter Connection Lever Lifting Rod with 202302
202302	13197	Knee Lifter Connection Lever Lifting Rod Cotter Pin
210875	15295	Knee Lifter Lifting Lever
200262u	15292	" " " " Hinge Screw
202976	10761	Needle Bar with 200141r
210543	10761	" " Connecting Link
202333	10761	" " " " Stud with 202254
202254	-----	Needle Bar Connecting Link Stud Oil Packing (wick)
200383c	10755	Needle Bar Connecting Link Stud Set Screw

Parts for Machine No. 107w12

No.	Plate	Name
200374c	10761	Needle Bar Connecting Link Stud Set Screw
210544	10761	Needle Bar Connecting Stud with 202277
210585	-----	Needle Bar Connecting Stud 210544 with 210545
202277	-----	Needle Bar Connecting Stud Oil Packing (wick)
210545	10761	Needle Bar Connecting Stud Swivel with 200387c
210725	15295	Needle Bar Crank with 200335c, 200374c, 200383c, 200428c and 202333
203172	10761	Needle Bar Crank Friction Washer
200428c	10761	" " " Position Screw ..
200335c	10755	" " " Set Screw
210726	-----	Needle Bar Crank complete, Nos. 202398 to 202400, 210543, 210585 and 210725
210546	15295	Needle Bar Frame with 200070c ...
210542	-----	" " " 210546 with 202976
210547	15292	" " " Guide Stud
200334c	15292	" " " " " Set Screw
210548	13174	Needle Bar Frame Hinge Stud ...
200334c	15292	" " " " " Set Screw
235208	15295	Needle Bar Frame Pitman
235209	15295	" " " " Fork
200066d	15292	" " " " " Screw
207125	14158	" " " " " " Washer
202277	-----	Needle Bar Frame Pitman Oil Packing (wick)
205975	14158	Needle Bar Frame Pitman Spring
235210	15296	" " " " " Bracket
200247f	14158	Needle Bar Frame Pitman Spring Bracket Hinge Screw
201528e	14158	Needle Bar Frame Pitman Spring Bracket Hinge Screw Nut
235211	14158	Needle Bar Frame Pitman Spring Collar
201471r	14158	Needle Bar Frame Pitman Spring Regulating Thumb Screw
201673d	14158	Needle Bar Frame Pitman Spring Regulating Thumb Screw Check Nut

Parts for Machine No. 107w12

No.	Plate	Name
235224	15292	Needle Bar Frame Pitman Stud (eccentric)
200070c	13197	Needle Bar Frame Pitman Stud Set Screw
235213	---	Needle Bar Frame Pitman complete, Nos. 200247e, 201528e, 202277, 207125, 210712, 224353, 235208 to 235210, two each 200066d, 200919c and 201522e ...
200387c	14158	Needle Bar Set Screw
200141f	10761	" Set Screw
235214	14158	" Vibrator Cam
200031f	14158	" " " Screw
235215	15296	" " " Shaft
210551	15296	" " " " Bearing and Cover
200566d	15292	Needle Vibrator Cam Shaft Bearing and Cover Screw (4)
210559	15292	Needle Vibrator Cam Shaft Collar with two 200378c
200378c	10760	Needle Vibrator Cam Shaft Collar Set Screw
210712	13174	Needle Vibrator Crank with 200378c and 200917c
224353	15292	Needle Vibrator Crank Link
200919c	14158	" " " " Hinge Screw
201522e	13197	Needle Vibrator Crank Link Hinge Screw Nut
210723	14158	Needle Vibrator Crank Link Oil Tube
200917c	14158	Needle Vibrator Crank Position Screw
200378c	10760	Needle Vibrator Crank Set Screw ..
210711	13174	" " " Shaft
235216	15296	" " Gear (spiral) with 200382c and 201472c
235217	----	Needle Vibrator Gear 235216 with 200031f and 235214
200382c	13197	Needle Vibrator Gear Set Screw ..
201472c	14158	" " " " " " ..
203172	10761	" " " Thrust Washer
235218	15292	" " Pinion (spiral) with two 200382c
200382c	13197	Needle Vibrator Pinion Set Screw ..
210770	15296	" " Regulating Lever with 200378c and 200917c

Parts for Machine No. 107w12

No.	Plate	Name
242052	15296	Needle Vibrator Regulating Lever Position Bracket (indexed) with 200378c, 200917c, two each 200326c and 201531e
200917c	14158	Needle Vibrator Regulator Lever Position Bracket Position Screw
200378c	10760	Needle Vibrator Regulating Lever Position Bracket Set Screw
200326c	10736	Needle Vibrator Regulating Lever Position Bracket Stop Screw ...
201531e	10760	Needle Vibrator Regulating Lever Position Bracket Stop Screw Nut
200917c	14158	Needle Vibrator Regulating Lever Position Screw
200378c	10760	Needle Vibrator Regulating Lever Set Screw
210772	14158	Needle Vibrator Regulating Lever Slide
201556d	14158	Needle Vibrator Regulating Lever Slide Thumb Nut
244033	---	Presser Bar (hollow)
202335	10751	" " 244033 with 200074e ..
207072	15292	" " Bushing
200352c	15292	" " " Set Screw
202554	15280	" " Lifter
200653c	15280	" " " Hinge Screw ...
210789	15280	" " Lifting Releasing Lever Bracket
200260d	15280	Presser Bar Lifting Releasing Lever Bracket Guide Screw
206608	15280	Presser Bar Lifting Releasing Lever Bracket Spring (spiral)
202337	15280	Presser Bar Position Guide
202338	15280	" " " " Lever with 200086f
200086f	15280	Presser Bar Position Guide Lever Pinch Screw
200352c	15292	Presser Bar Position Guide Set Screw
202378	13174	Presser Bar Spring (heavy)
202346	10751	" " " Stop Rod
200492b	15280	" " Thumb Screw (pressure regulating)
200475b	15280	Presser Bar Thumb Screw Thumb Set Screw
202355	15292	Presser Bar Thumb Screw Thumb Set Screw Packing (brass)

Parts for Machine No. 107w12

No.	Plate	Name
242053	15292	Presser Foot Edge Guide
200175H	13197	" " " " Screw
230795	15280	" " Hinge Pin
242054	—	" " Plate
200074F	15292	" " Screw
202923	—	" " Shank
242055	15292	Presser Foot (hinged) complete, Nos. 200175H, 202923, 230795, 242053 and 242054
202398	10761	Take-up Lever
202399	10761	" " Driving Stud with 202277
202277	—	Take-up Lever Driving Stud Oil Packing (wick)
202400	10761	Take-up Lever Hinge Stud with 202423
202423	—	Take-up Lever Hinge Stud Oil Packing (wick)
200383C	10755	Take-up Lever Hinge Stud Set Screw
202401	—	Take-up Lever Oiling Felt
200132E	10761	" " " " Screw ..
244048	15292	Tension Disc (back)
207967	15292	" " (front)
202404	15292	" Release Plunger
235221	14158	" " Washer
202407	10881	" Spring
200625F	15292	" Stud with 204925
200061C	10736	" " Set Screw
204925	13197	" " Washer
201572B	10881	" Thumb Nut
235222	—	Tension complete, Nos. 200625F, 201572B, 202407, 202682, 207967, 235221 and 244048
202682	15292	Thread Controller Spring
202411	15294	" " " " Stop
200132E	10761	" " " " "
		Screw
210954	15294	Thread Guide (lower)
210955	15294	" " (upper)
210595	15294	" " (on side of arm)
202412	15294	" " (on top of arm)
200582H	15294	" " Screw (3)
210683	10736	" Retainer Bracket with 200397H
200137H	10736	" " " Screw
210684	—	Thread Retainer Bracket complete, Nos. 210683, 210957, 210958, 210992 and 210993

Parts for Machine No. 107w12

No.	Plate	Name
210960	15294	Thread Retainer Disc
210961	15294	" " Plunger
210962	15294	" " Spring
210993	10736	" " Sleeve
210963	15294	" " Socket
200389C	15294	" " " Set Screw ...
210992	10736	" " Spring
210957	10736	" " Stud
210958	10736	" " Collar
200397H	10736	" " " Set Screw ...
210603	14156	Throat Plate, 53 needle hole, for needle sizes 12 and 13
200577H	10755	Throat Plate Screw (2)

ACCESSORIES

No.	Plate	Name
200157B	15294	Attachment Screw
210530	13174	Bobbin
*225482	---	" Case Screw Driver Blade ...
*225483	---	" " " " Handle ..
225497	12345	Bobbin Case Screw Driver complete, Nos. 225482 and 225483
231337	---	Cloth Guide
133 x 9	---	Needles, six, size 18
228212	---	Drip Pan with four 1 in. wire nails
41400	12345	Machine Rest Pin (wood)
120342	12345	Oiler (copper plated) with 120343
120343	12345	" Spout, 3½ in. long
*225484	---	Screw Driver Blade
*225485	---	" " Handle
225498	12345	Screw Driver complete (7¼ in. long), Nos. 225484 and 225485 ...
225554	12345	Wrench (steel)

BOBBIN WINDER

Swing Automatic, Right Hand

225453	10884	Frame with 202277 and 225438
225454	10884	" Hinge Pin
202277	---	" Oil Packing (wick)
225438	10884	" " Well Cap
225455	10884	" Spring
225456	10884	" " Plunger
202473	10885	Pulley with 200380c
200380c	---	" Set Screw
225381	10884	Spindle
225444	10884	Stop Latch
200056E	10884	" " Screw
225458	10884	" " Thumb Lever
225459	10884	" " " " Hinge Stud
225459	10884	" " " " Joint Stud
202478	10884	" " Trip Lever
200299H	10884	" " " " Hinge Screw
225461	10881	Tension Bracket with 201499B
200082D	10881	" " Screw
228026	10884	" " " Washer
2102	10881	" Disc
202407	10881	" Spring
201499B	10881	" Stud
201572B	10881	" " Thumb Nut

Accessories

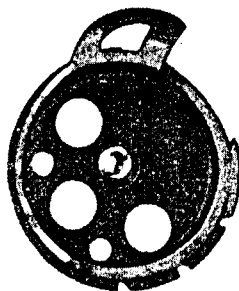
No.	Plate	Name
225462	10881	Bobbin Winder Tension Bracket complete, Nos. 201572B, 202407, 225461 and two 2102
225433	10885	Bobbin Winder and Tension Bracket Base
225382	10885	Universal Bobbin Winder complete, Nos. 200056E, 200082D, 200299H, 202473, 202478, 225381, 225433, 225444, 225453 to 225456, 225458, 225462, 228026, two each 225459 and wood screws ¾ in., No. 12, R.H.B.

KNEE LIFTER

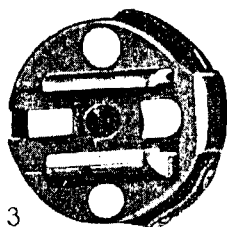
2763	13395	Rock Shaft
228278	13395	" " Hanger (back) with 356c
228279	---	" " " 228278 with 202452 and 228282
228280	13395	Rock Shaft Hanger (front) with two 356c
228281	---	Rock Shaft Hanger 228280 with 202452 and 228282
228282	13395	Rock Shaft Hanger Bracket with two wood screws ¾ in., No. 12 ..
202452	15294	Rock Shaft Hanger Hinge Pin
202455	13395	" " Knee Arm
356c	15294	" " " " Set Screw ..
228284	13395	" " " Plate with 356c ..
356c	15294	" " " " Set Screw ..
228283	13395	" " Lifting Lever with two 356c
227728	13395	Rock Shaft Lifting Lever Rod with 227729
227729	---	Rock Shaft Lifting Lever Rod Cap
356c	15294	" " " " " Set Screw
356c	15294	Rock Shaft Lifting Lever Set Screw
356c	15294	" " Set Screw
228285	13395	Knee Lifter Rock Shaft complete, Nos. 2763, 202455, 227728, 228279, 228281, 228283 and 228284

PLATE 10736-FULL SIZE

210846



210729

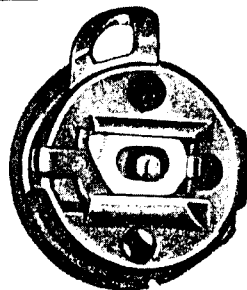
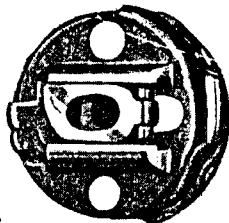


210913

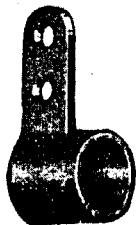


210847

210915



210683



210992



210957



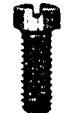
200326



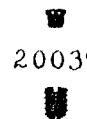
210993



200061



201016



200397

210958



200363



200137



PLATE 10751—ONE-HALF SIZE

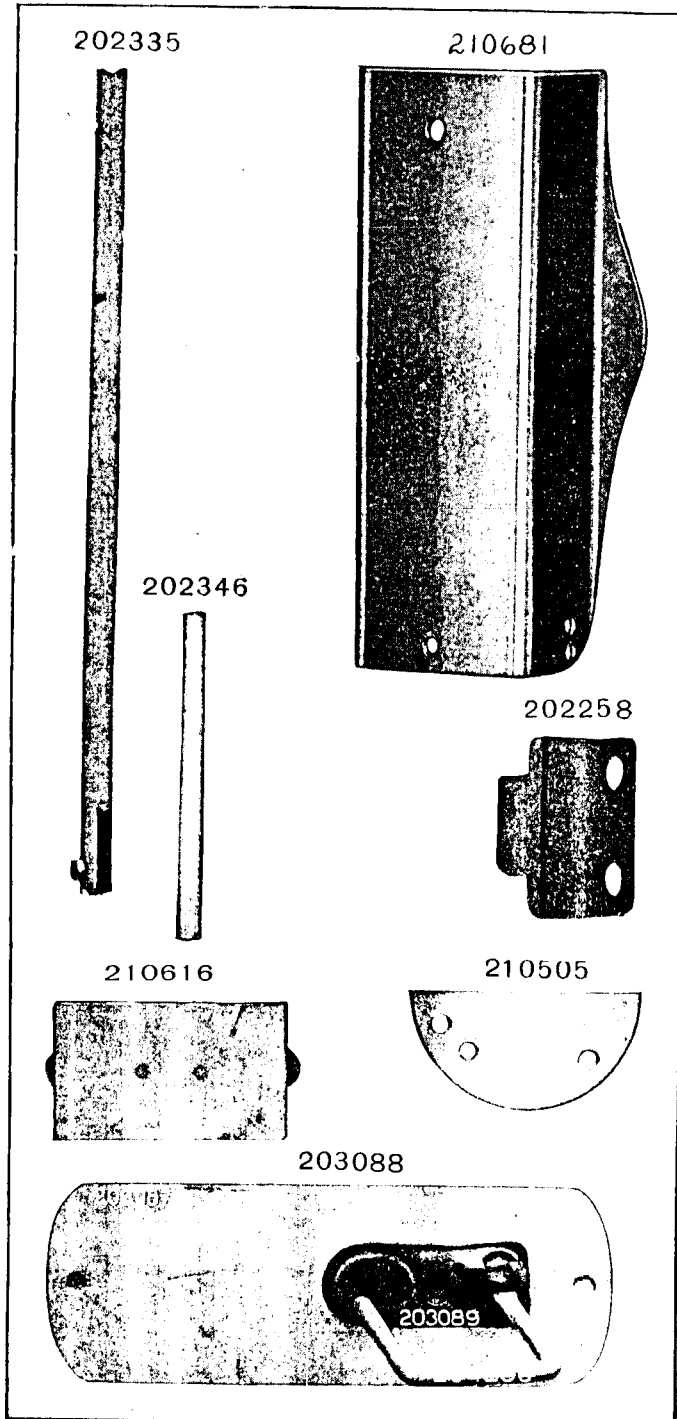


PLATE 10752—ONE-HALF SIZE

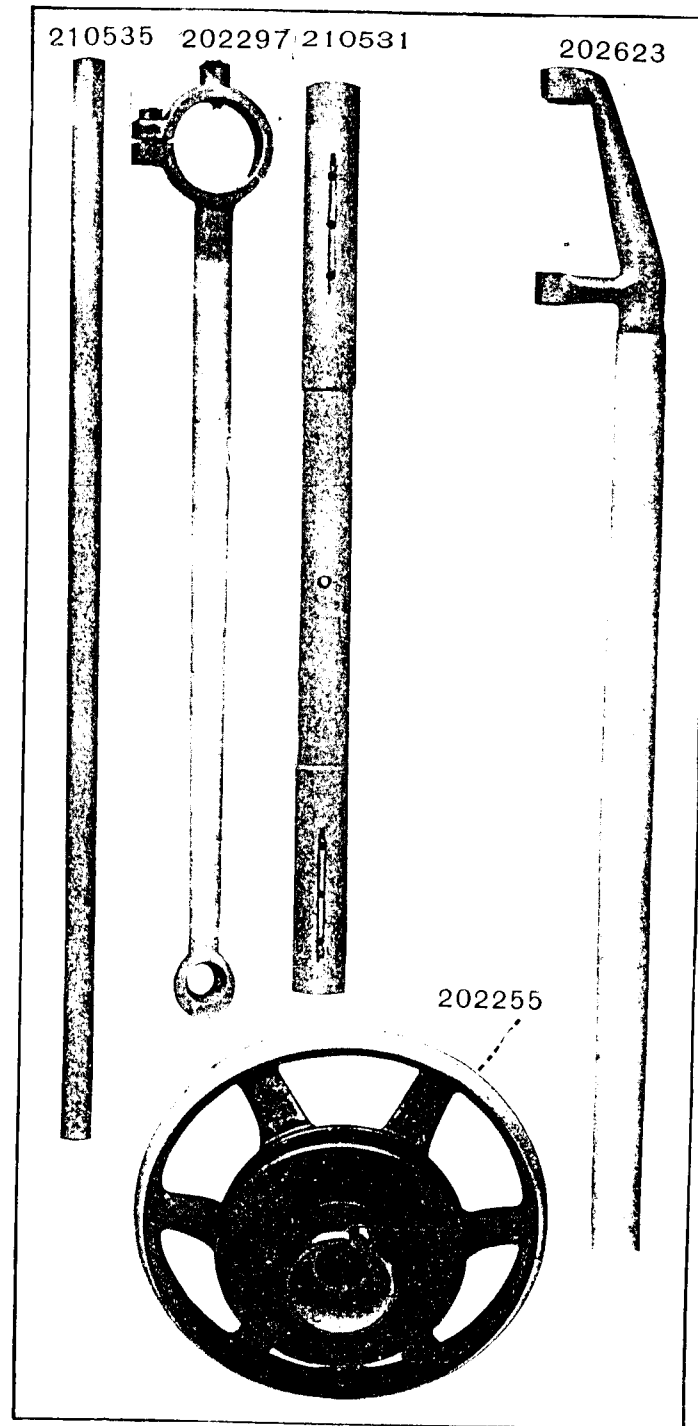


PLATE 10755—FULL SIZE

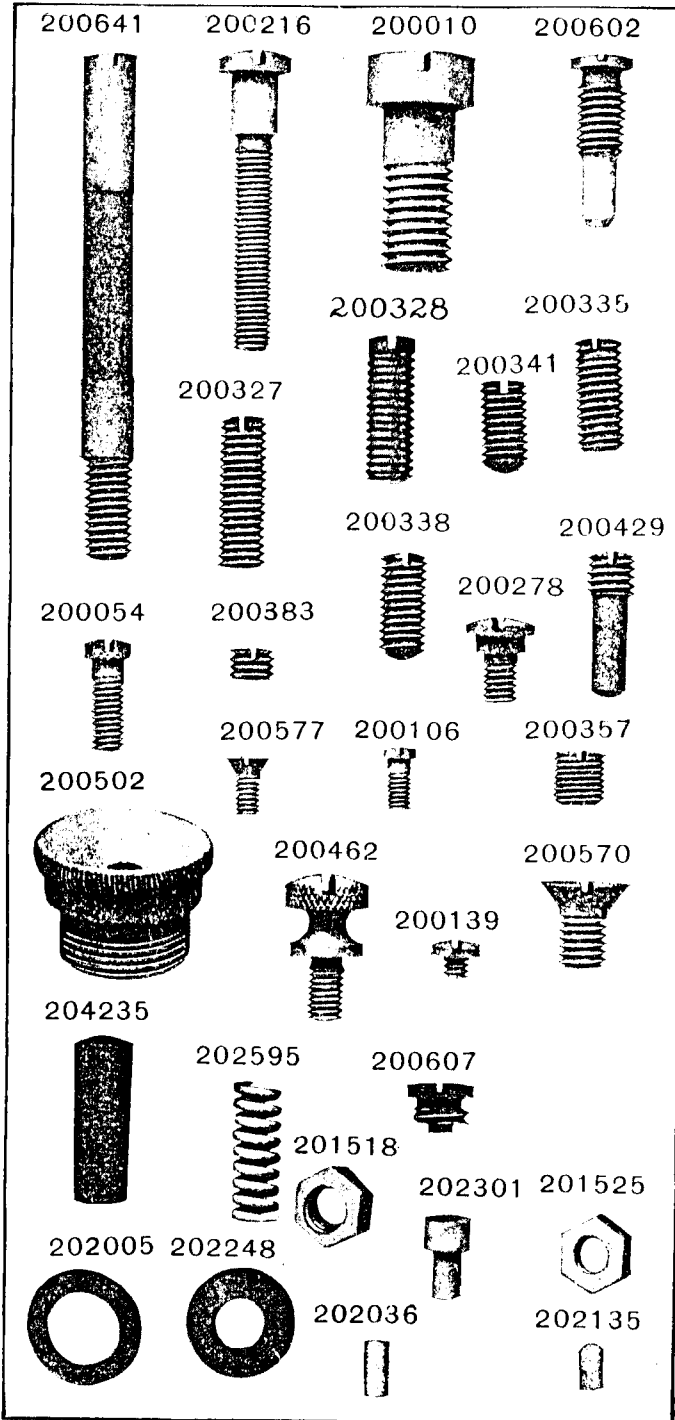


PLATE 10757—FULL SIZE

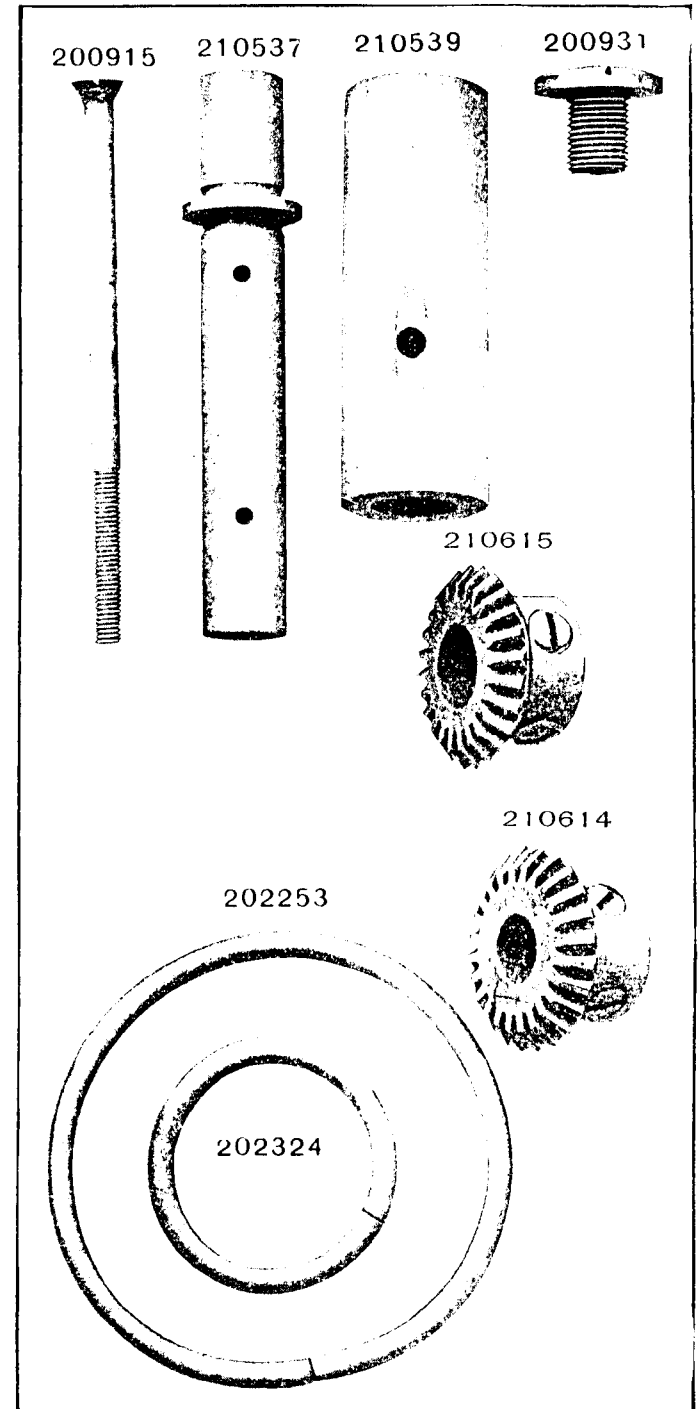


PLATE 10760—FULL SIZE

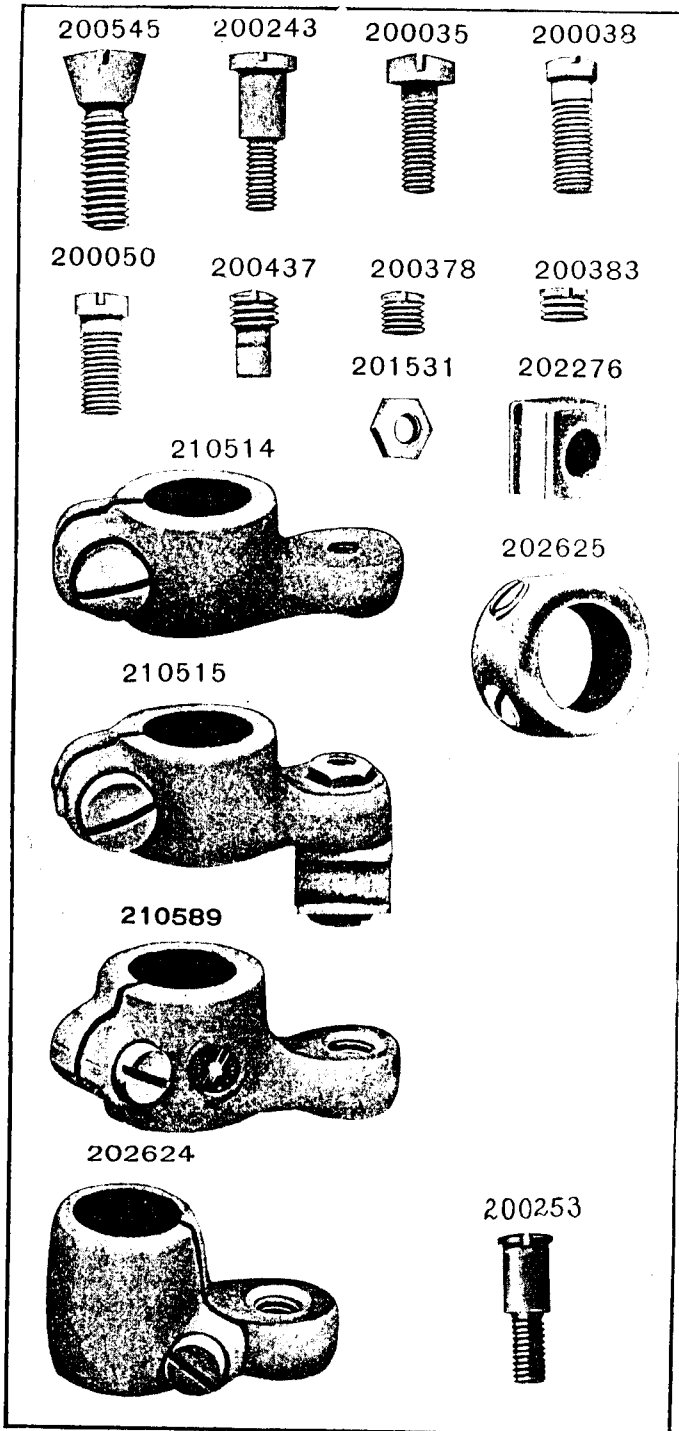


PLATE 10761—FULL SIZE

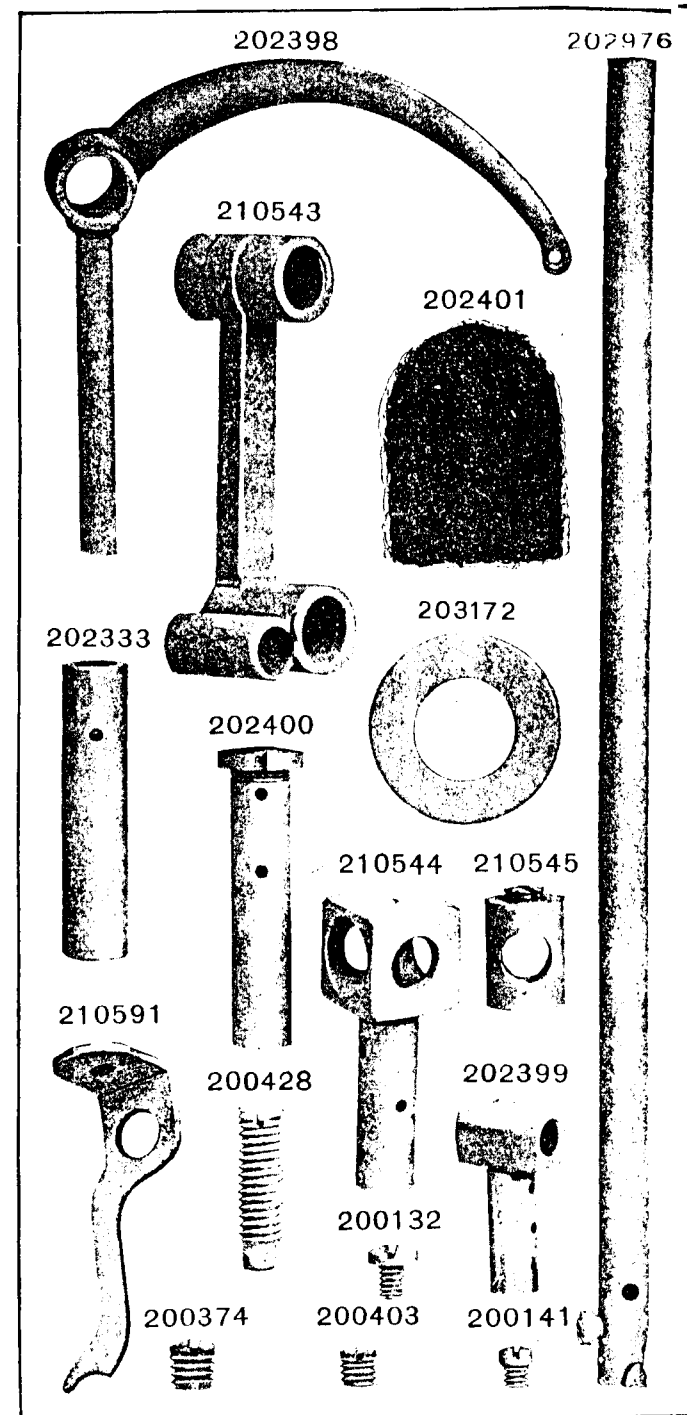
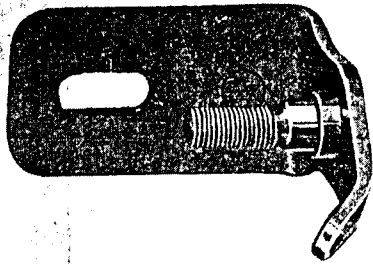


PLATE 10881—FULL SIZE

225461



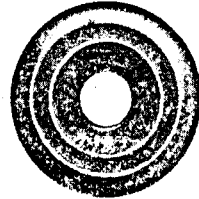
200082



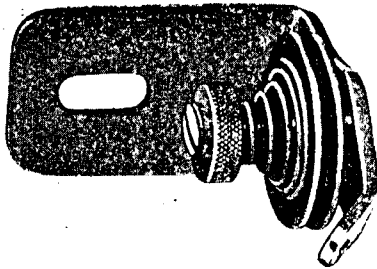
202104



2102



225462



202407



201499

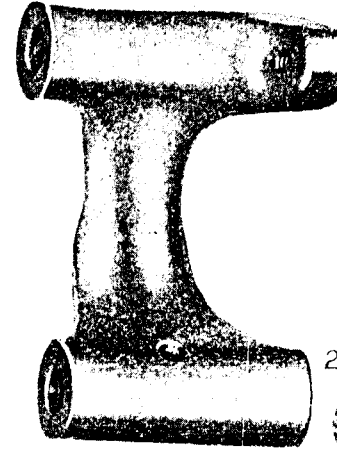


201572

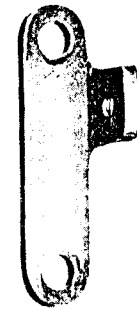


PLATE 10884—FULL SIZE

225453



225444 202478



228026



225458



225460



225454



200299



225438



200056



225459



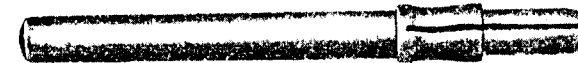
200105



225456



225381



225455

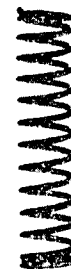
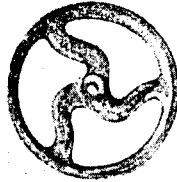


PLATE 10885—ONE-FOURTH SIZE

225433



202473



225382

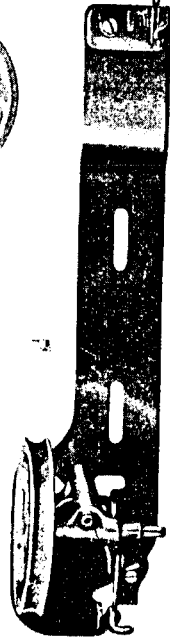


PLATE 12345—ONE-HALF SIZE

41400



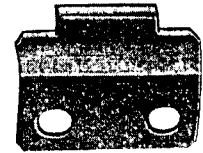
225497



225498



202258



225554



120342

120343

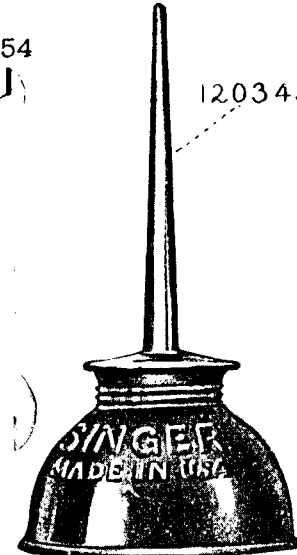


PLATE 13174-FULL SIZE

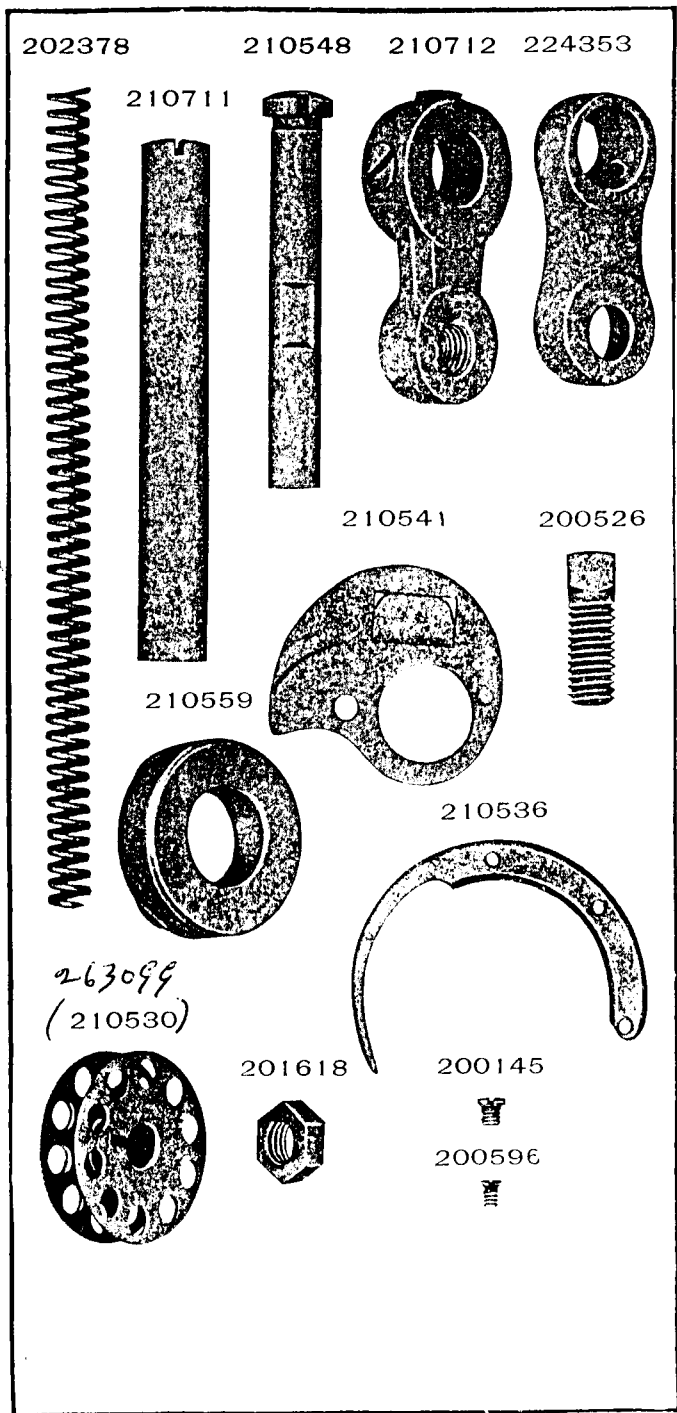


PLATE 13197-FULL SIZE

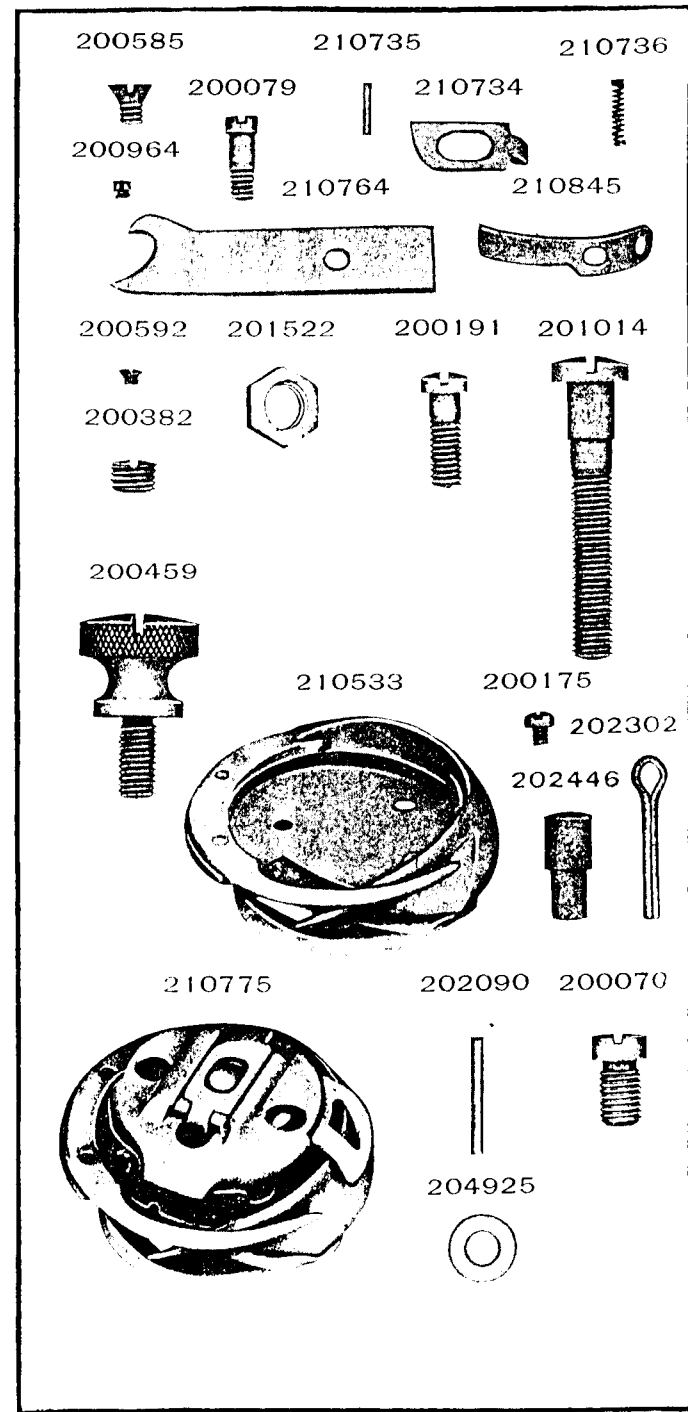


PLATE 13395—ONE-FOURTH SIZE

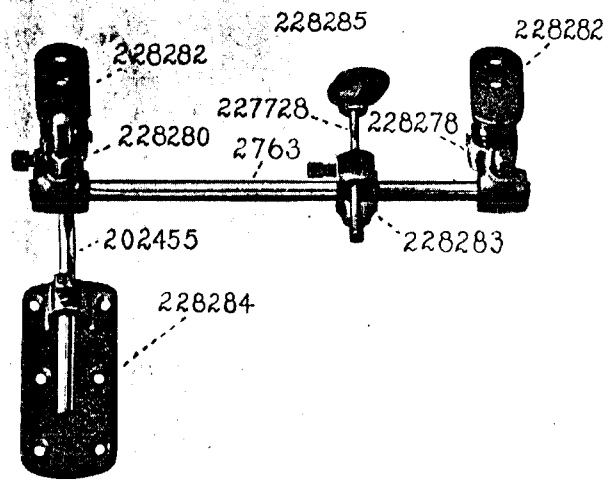
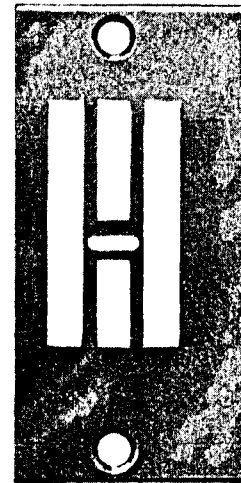


PLATE 14156—FULL SIZE

210603



242018

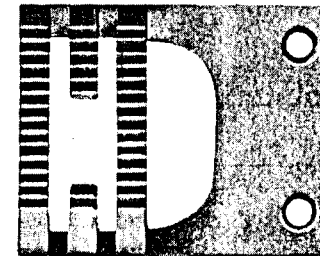


PLATE 14158—FULL SIZE

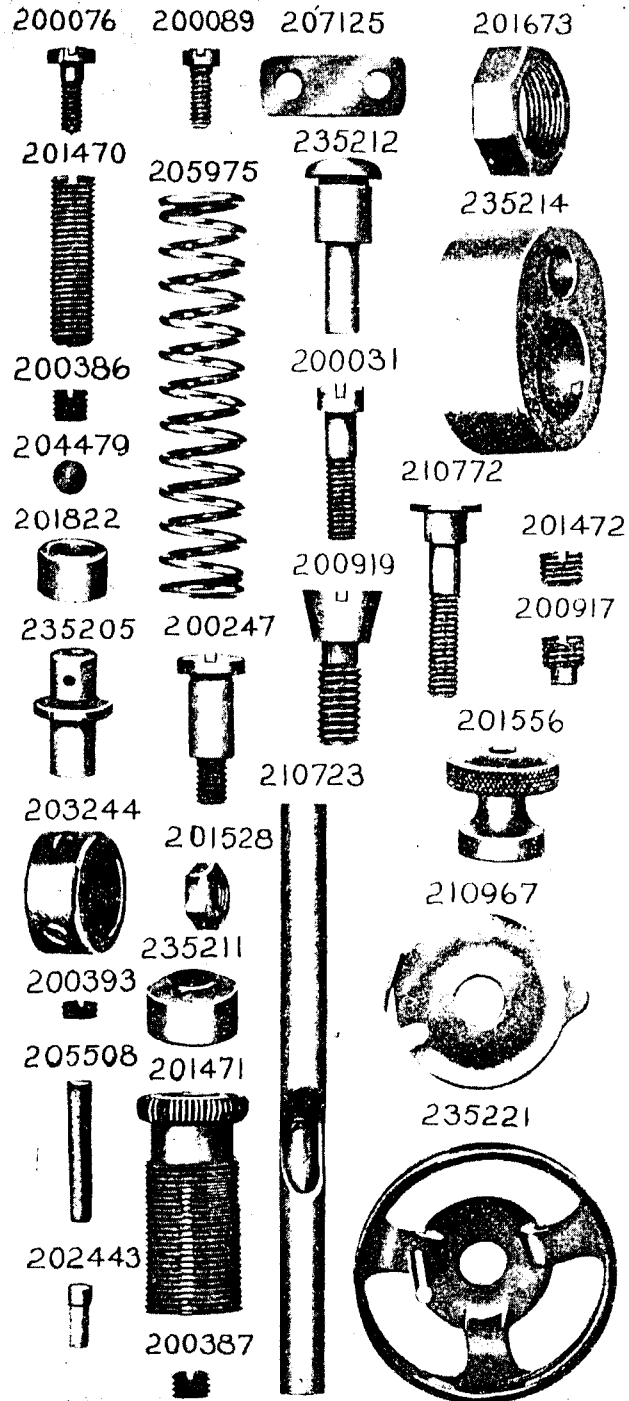


PLATE 15280—FULL SIZE

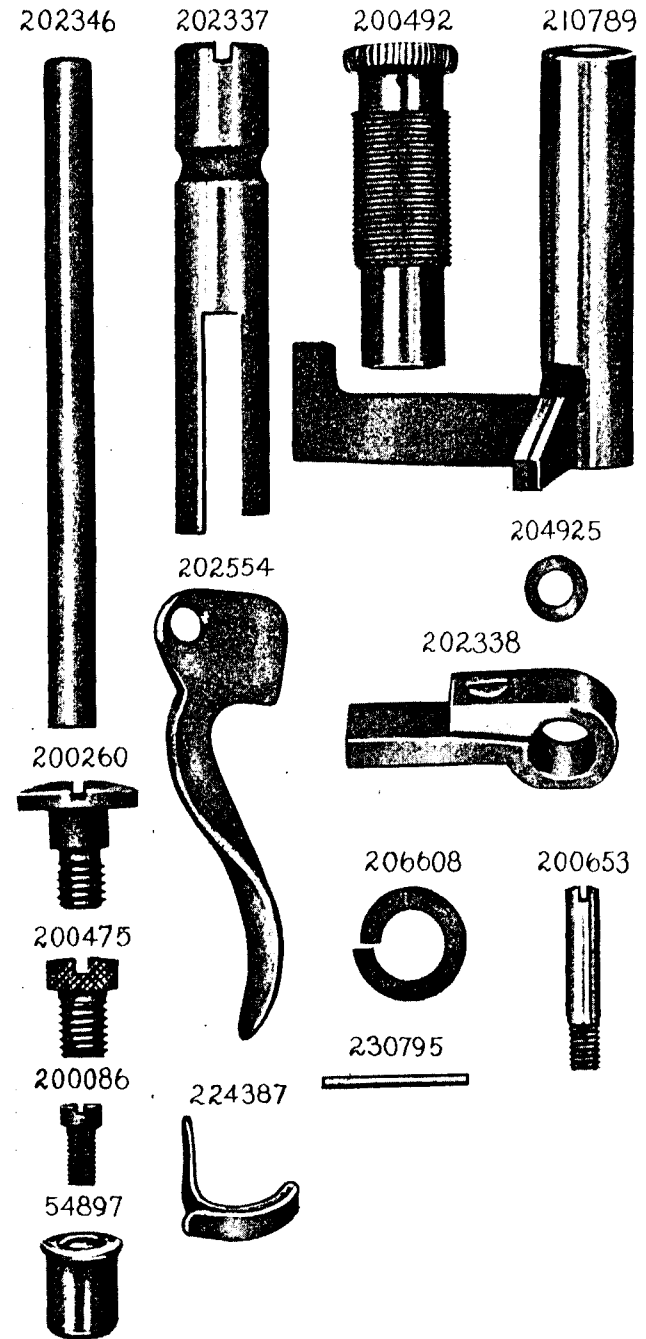


PLATE 15292—FULL SIZE

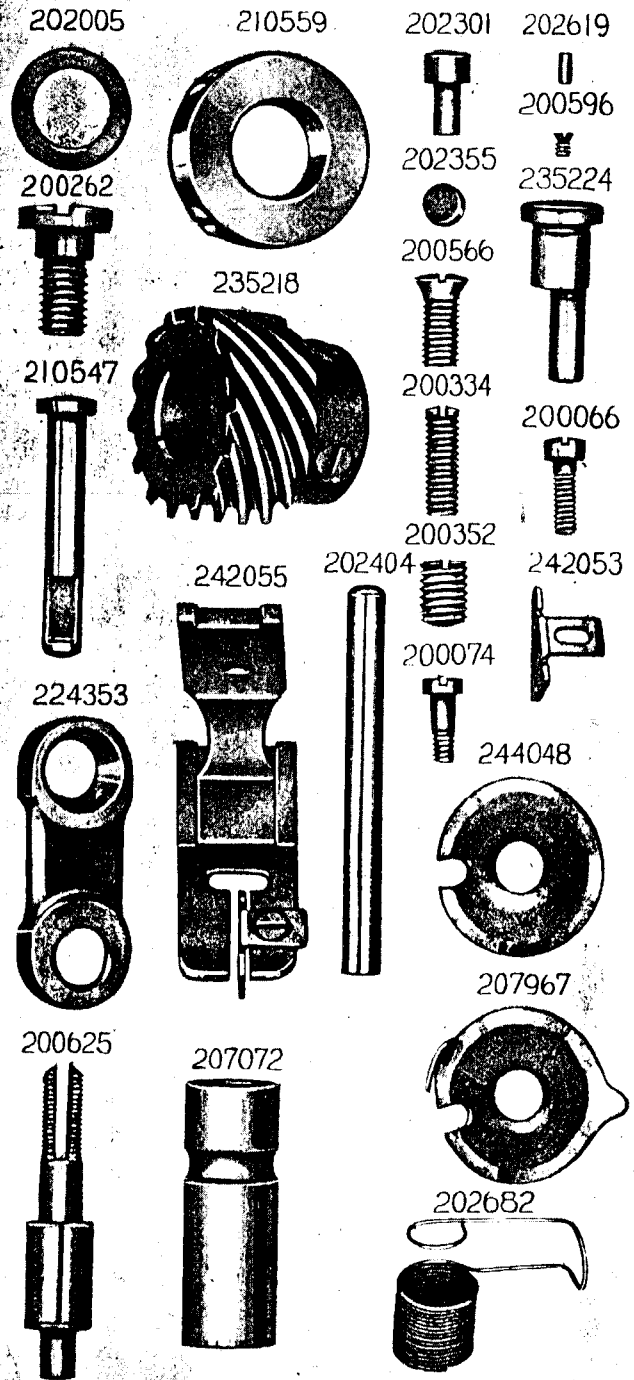


PLATE 15293—ONE-HALF SIZE

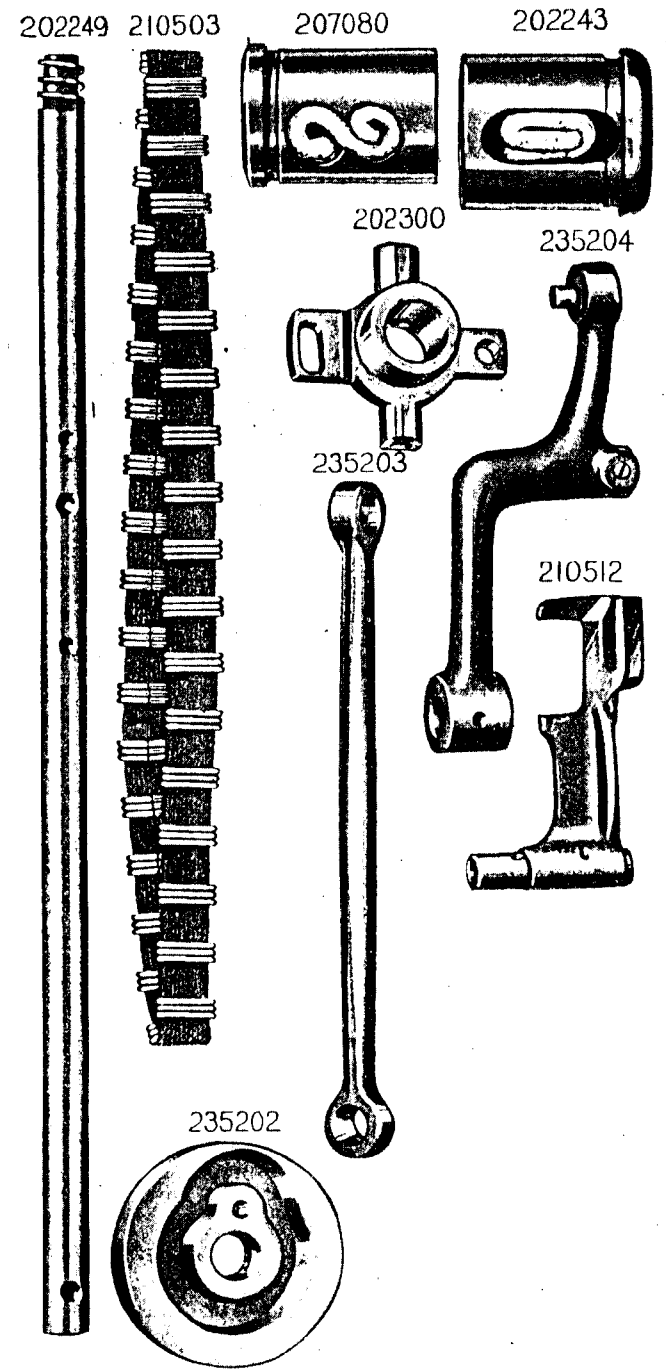


PLATE 15294—FULL SIZE

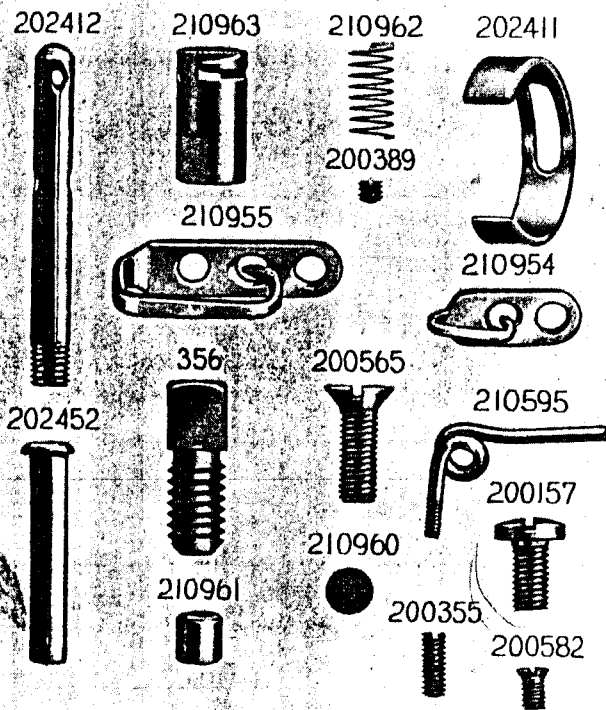


PLATE 15295—ONE-HALF SIZE

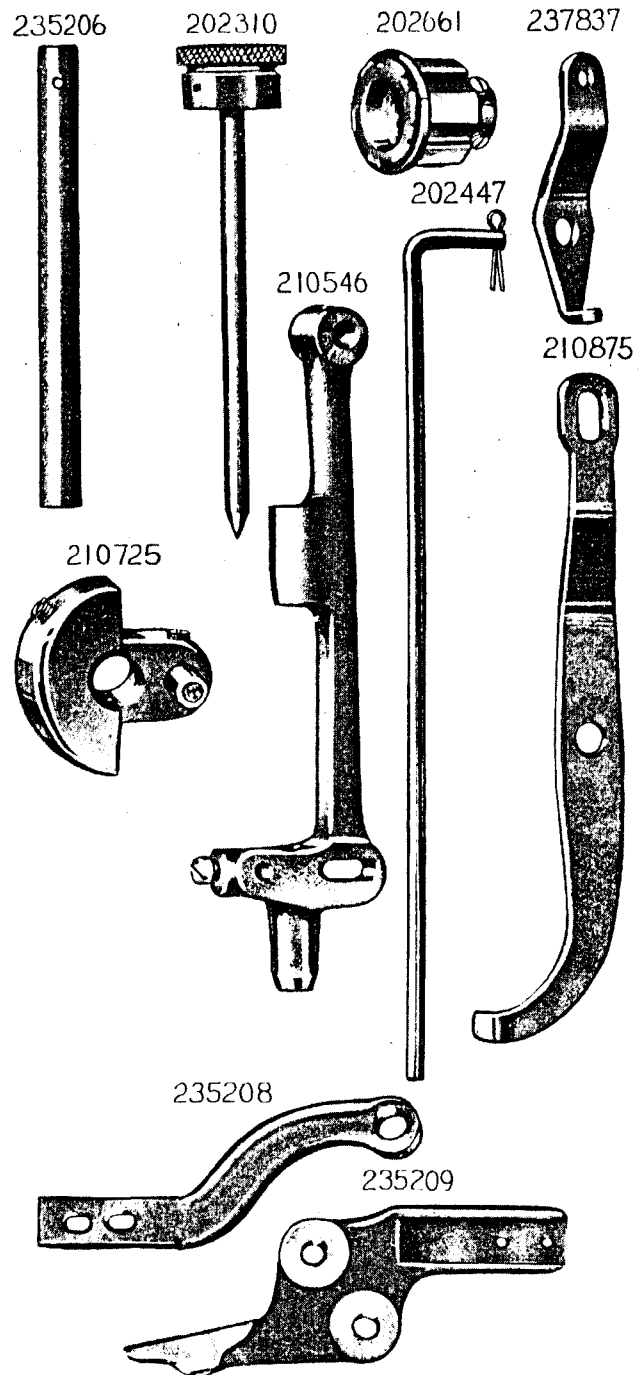
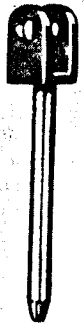


PLATE 15296—ONE-HALF SIZE

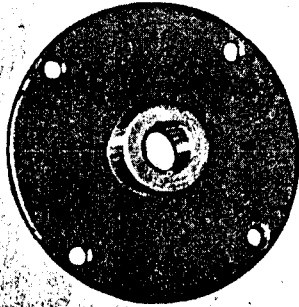
235215



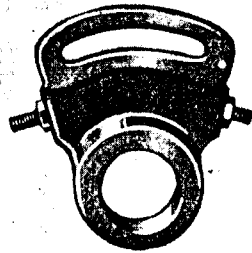
235210



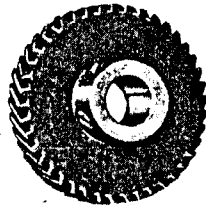
210551



242052



235216



210770

