

Singer 7-33

Form 20538 (551)  
Printed in U.S.A.

# LIST OF PARTS



MACHINE No. 7-33

---

\*\* A TRADE MARK OF  
**THE SINGER MANUFACTURING COMPANY**

## INSTRUCTIONS FOR OILING

---

To ensure easy running and prevent unnecessary wear of the parts which are in movable contact, the machine requires oiling and when in continuous use, "TYPE B" or "TYPE D" OIL, sold only by Singer Sewing Machine Company, should be applied at least twice each day to all oil holes marked "OIL", as instructed in Form 20537.

"TYPE D" OIL is stainless.

## INDEX

---

	Page
Accessories.....	16
Bobbin Winder.....	16
Machine No. 7-33.....	7
Numerical List of Parts.....	19
Thread Unwinder.....	17

Copyright, U. S. A., 1918, 1940 and 1951

by The Singer Manufacturing Co.

All Rights Reserved for all Countries

## INSTRUCTIONS FOR ORDERING

In ordering from this list, use **ONLY** the part **NUMBER** in the **FIRST** Column.

The number stamped on a Sewing Machine Part is in every case the number of the single part only.

Every combination of parts sent out as such has its specific number, which, although not stamped on the parts, must be used when ordering the combination.

Each number always indicates the **SAME PART** in whatever list it appears, or for whatever machine.

The letters after some of the numbers indicate the style of finish only, as follows:

A-Hardened, Polished, Nickel Plated and Buffed.

A.A-Buffed and Chromium Plated.

A.B-Hardened, Polished, Buffed and Chromium Plated.

A.C-Brown Baking Enamel Finish.

A.D-Gray Baking Enamel Finish.

A.E-Hardened, Bright Rumbled and Nickel Plated.

A.F-Hardened, Bright Rumbled, Nickel Plated, Bright Rumbled and Chromium Plated.

A.G-Alumilite, Plain.

A.H-Alumilite Dyed.

A.J-Polished, Nickel Plated and Chromium Plated.

A.K-Hardened, Polished, Nickel Plated and Chromium Plated.

A.L-Heat Treated for Toughness.

B-Polished, Nickel Plated and Buffed.

C-Hardened only.

C.R-Hardened and Merlized.

D-Polished Only.

E-Soft, Not Polished.

F-Hardened and Polished.

F.J-Hardened, Polished and Nickel Plated.

G-Bright Rumbled and Nickel Plated.

H-Blued.

J-Nickel Plated Only.

K-Hardened and Nickel Plated.

L-Brass Plated.

M-Oxidized.

N-Japanned, Dull.

## INSTRUCTIONS FOR ORDERING - Continued

P-Japanned, Bright.

P.P-Wrinkle Finish.

R-Merlized.

S-Cadmium Plated.

T-Copper Plated.

T.A-Hardened, Polished, Copper and Nickel Plated and Buffed.

T.B-Copper and Nickel Plated and Polished.

T.J-Copper and Nickel Plated Only.

T.K-Hardened, Copper and Nickel Plated.

T.L-Copper and Brass Plated.

T.M-Copper Plated and Oxidized.

U-Zinc Plated.

V-Silver Plated.

W-Polished and Nickel Plated.

X-Black Oxide, for Iron and Steel.

X.C-Hardened and Black Oxide, for Iron and Steel.

Y-Black Nickel Plated Only.

Z-Chromium Plated.

Z.A-Hardened, Polished, Nickel Plated, Buffed and Chromium Plated.

Z.B-Polished, Nickel Plated, Buffed and Chromium Plated.

Z.C-Hardened and Chromium Plated.

Z.D-Polished and Chromium Plated.

Z.G-Bright Rumbled, Nickel Plated, Bright Rumbled and Chromium Plated.

Z.J-Nickel and Chromium Plated.

Z.T-Copper and Chromium Plated.

These letters **MUST BE USED** when they appear in the list; and **AFTER** the number as in the list.

In this series:

I to 1500, 50001 to 51500 and 140001 to 142000 are Screw Numbers.

1501 to 1800 and 51501 to 51800 are Nut Numbers.

1801 to 2000 and 51801 to 52000 are Roller Numbers.

2001 to 50000 and 52001 to 140000 and 142001 to 190000 are Sewing Machine Parts, 190001 and upward are numbers of Electrical Parts.

The figures in the second column refer only to the plates, illustrating the parts, and are **NOT TO BE USED** in ordering.

Parts marked with an asterisk (\*) are furnished only when repairs are made at factory.

## LIST OF PARTS COMPLETE

FOR

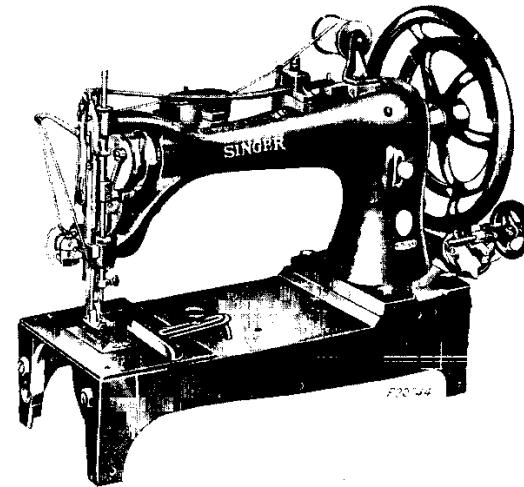

## MACHINE No. 7-33

Heavy work in canvas. Length of stitch 2 to 8 to the inch. Clearance under presser foot 9/16". Alternating pressers. Machine pulley 58677, for 1/2" V-Belt. Speed 550, depending on material used and operation performed.

No.	Plate	Name
*59257	-----	Arm with 15404 and two 15405.....
8702	4475	" Dowel Pin (2).....
58548	22799	" Oil Tube for oiling Arm Shaft (intermediate) Bearing.....
50348E	22799	Arm Screw (4).....
19923	22801	" Shaft.....
68350	22799	" " Bearing (back and front) Oil Cup (?).....
11354	4463	Arm Shaft Bushing.....
437C	4478	" " " Set Screw.....
949E	22799	" " " Screw.....
49095	22799	" " " Washer.....
11913	22802	" Side Cover.....
65D	4477	" " " Hinge Screw.....
58677	22800	Balance Wheel (10 in. diam.) 1/2 in. "V" belt groove, with two 350C.....

No.	Plate	Name
350C	22799	Balance Wheel Set Screw (2).....
*19832	-----	Bed.....
58222	22803	Cloth Plate.....
51464F	22799	" " Screw.....
19758	22801	Crank Connecting Rod with two 575E
575E	4476	" " " Cap Screw (2)
1151C	4476	" " " Hinge Screw..
1646E	22799	" " " " " "
		Nut.....
11365	4464	Feed Bar.....
50358C	4478	" " Screw Center (2).....
58338	-----	" " " " 50358C with
		1513J (2).....
1513J	22799	Feed Bar Screw Center Nut (2).....
11367	4463	" Cam with two 445C.....
445C	4478	" " Set Screw (2).....
11368	4465	" Connecting Link.....
565C	4476	" " " Hinge Screw..
1513J	22799	" " " " " "
		Nut.....
19834	4436	Feed Dog (double).....
19835	4437	" " (single).....
		Note: No. 19834 is regularly furnished with this machine.
166D	4476	Feed Dog Screw.....
19762	22801	" Forked Connection.....
565C	4476	" " " Hinge Screw
		(2).....
1513J	22799	Feed Forked Connection Hinge Screw
		Nut (2).....
9225	22801	Feed Lifting Rock Shaft with 134E, 2022 and 19967.....
58288	-----	Feed Lifting Rock Shaft complete, Nos. 9225 and 19837.....
19837	4463	Feed Lifting Rock Shaft Crank with 692D and 1861.....
692D	22799	Feed Lifting Rock Shaft Crank
		Clamping Screw.....
1861	4475	Feed Lifting Rock Shaft Crank
		Roller and Stud.....
58549	22799	Feed Lifting Rock Shaft Front
		Bearing Oil Tube with 52045...
52045	22799	Feed Lifting Rock Shaft Front
		Bearing Oil Tube Packing
		(cotton).....
1015C	4478	Feed Lifting Rock Shaft Screw Center (left).....
1503E	4478	Feed Lifting Rock Shaft Screw Center (left) Nut.....
294C	4478	Feed Lifting Rock Shaft Screw Center (right).....
1503E	4478	Feed Lifting Rock Shaft Screw Center (right) Nut.....
19967	22802	Feed Lifting Rock Shaft Wearing Block.....
2022	4465	Feed Lifting Rock Shaft Wearing Block Position Pin.....

No.	Plate	Name
134E	4465	Feed Lifting Rock Shaft Wearing Block Screw.....
11375	4464	Feed Regulator.....
568E	4477	" " Hinge Screw.....
50322D	4477	" " Thumb Screw.....
58243	22801	" Rock Shaft.....
24131	22799	" " " Back Bearing Oil
		Tube with 52045.....
52045	22799	Feed Rock Shaft Back Bearing Oil
		Tube Packing (cotton).....
58235	4465	Feed Rock Shaft Crank with 346E...
346E	4465	" " " Clamping
		Screw.....
58561	22799	Feed Rock Shaft Front Bearing Oil
		Tube.....
1015C	4478	Feed Rock Shaft Screw Center (left).....
1503E	4478	Feed Rock Shaft Screw Center (left) Nut.....
294C	4478	Feed Rock Shaft Screw Center (right).....
1503E	4478	Feed Rock Shaft Screw Center (right) Nut.....
58244	-----	Feed Rock Shaft complete, Nos. 58235 and 58243.....
36114	4456	Guide (6 in. face) for 19855.....
26419	4463	" (6 in. face) for 19858.....
885D	4477	" Thumb Screw.....
58258	4464	Lifting Presser Bar.....
58617	22802	" " " Bell Crank....
58618	22804	" " " " "
		Hinge Stud.....
50083AL	22804	Lifting Presser Bar Bell Crank
		Hinge Stud Set Screw.....
58619	22804	Lifting Presser Bar Bell Crank
		Slide Block.....
58621	-----	Lifting Presser Bar Bell Crank
		Slide Block 58619 with 610E...
610E	4465	Lifting Presser Bar Bell Crank
		Slide Block Screw.....
1518E	4465	Lifting Presser Bar Bell Crank
		Slide Block Screw Nut.....
2718	4465	Lifting Presser Bar Bell Crank
		Slide Block Screw Nut Washer..
58643	22802	Lifting Presser Bar Bracket with two 145E.....
145E	4473	Lifting Presser Bar Bracket Clamp- ing Screw (2).....
11909	4464	Lifting Presser Bar Lifter with 8761 and 8763.....
8760	4465	Lifting Presser Bar Lifter Fric- tion Washer.....
16D	4477	Lifting Presser Bar Lifter Hinge Screw.....
8761	4465	Lifting Presser Bar Lifter Stop Pin.....

No.	Plate	Name
11907	4463	Lifting Presser Bar Lifting Link..
166D	4476	" " " " " "
		Cap Screw.....
8763	4465	Lifting Presser Bar Lifting Link
		Hinge Stud.....
8973	4465	Lifting Presser Bar Lifting Link
		Hinge Stud Pin.....
43267	4465	Lifting Presser Bar Lifting Link
		Hinge Stud Washer.....
11479	4466	Lifting Presser Bar Rock Shaft....
58578	22802	" " " " " Ad-
		justing Arm with 453AL.....
58656	22804	Lifting Presser Bar Rock Shaft Ad-
		justing Arm Pin.....
453AL	4466	Lifting Presser Bar Rock Shaft Ad-
		justing Arm Set Screw.....
11481	4463	Lifting Presser Bar Rock Shaft
		Bracket.....
58245	-----	Lifting Presser Bar Rock Shaft
		Bracket 11481 with 11479,
		11484, 58579 and 58656.....
2002	4475	Lifting Presser Bar Rock Shaft
		Bracket Dowel Pin (lower)....
4389	4475	Lifting Presser Bar Rock Shaft
		Bracket Dowel Pin (upper)....
123E	4476	Lifting Presser Bar Rock Shaft
		Bracket Screw.....
11484	4466	Lifting Presser Bar Rock Shaft
		Crank with 453AL and 1850.....
58656	22804	Lifting Presser Bar Rock Shaft
		Crank Pin.....
1850	4466	Lifting Presser Bar Rock Shaft
		Crank Roller and Stud.....
453AL	4466	Lifting Presser Bar Rock Shaft
		Crank Set Screw.....
11486	22802	Lifting Presser Bar Rock Shaft Ec-
		centric Strap with two each
		141E and 1528C.....
141E	4476	Lifting Presser Bar Rock Shaft Ec-
		centric Strap Adjusting Screw
		(2).....
1528C	22805	Lifting Presser Bar Rock Shaft Ec-
		centric Strap Adjusting Screw
		Nut (2).....
608C	4466	Lifting Presser Bar Rock Shaft Ec-
		centric Strap Hinge Screw....
1518E	4465	Lifting Presser Bar Rock Shaft Ec-
		centric Strap Hinge Screw Nut.
11487	4466	Lifting Presser Bar Rock Shaft Ec-
		centric Strap Hinge Screw
		Slide.....
11488	4466	Lifting Presser Bar Rock Shaft Ec-
		centric Strap Hinge Screw
		Slide Washer.....
258E	4477	Lifting Presser Bar Screw Bushing.
11489	4466	" " " Sleeve (lower)

No.	Plate	Name
11490	4466	Lifting Presser Bar Sleeve (upper)
11492	4466	" " " " " "
		Cap.....
11493	22801	Lifting Presser Bar Spring (flat).
58252	4463	" " " " Bracket
1177D	4476	" " " " " "
		Screw.....
4389	4475	Lifting Presser Bar Spring Guide
		Pin.....
50323D	22804	Lifting Presser Bar Spring Regu-
		lating Thumb Screw.....
58260	4467	Lifting Presser Foot with 1259AL,
		for 19834.....
58261	4467	Lifting Presser Foot with 1259AL,
		for 19835.....
1259AL	4478	Lifting Presser Foot Set Screw....
11539	4464	Needle Bar.....
11539	4468	" " Connecting Link.....
566C	4468	" " " " Hinge
		Screw.....
1513J	22799	Needle Bar Connecting Link Hinge
		Screw Nut.....
11383	4468	Needle Bar Connecting Stud with
		two 445F.....
19981	-----	Needle Bar Connecting Stud 11383
		with 11539.....
445F	4478	Needle Bar Connecting Stud Set
		Screw (2).....
258E	4477	Needle Bar Screw Bushing.....
19702	4468	" Clamp with 680F and 11385..
11385	4468	" " Gib.....
680F	4468	" " Thumb Screw.....
11917	-----	Oil Cup Cover.....
9084	4468	" " " Hinge Pin.....
2205	4468	" " " Latch Spring.....
207F	4468	" " " " Screw..
8953	4468	" or Wax Stripper (felt) (2)....
207F	4468	" " " " Screw (2).....
11918	4468	" " " " Washer (steel)
		for Cover.....
8482	4468	Oil or Wax Stripper Washer (steel)
		for Oil Cup.....
58254	22803	Oil Cup complete, Nos. 2205, 8482,
		9084, 11917, 11918, two 8953
		and three 207F.....
134D	4465	Oil Cup Screw.....
58550	22803	Oscillating Rock Shaft.....
58552	22802	" " " Hinge Pin..
58595	-----	" " " " " "
		58552 with 1503J.....
1503J	4478	Oscillating Rock Shaft Hinge Pin
		Nut.....
51227C	22805	Oscillating Rock Shaft Hinge Pin
		Screw Bearing.....
1503J	4478	Oscillating Rock Shaft Hinge Pin
		Screw Bearing Nut.....

No.	Plate	Name
11165	4469	Oscillating Rock Shaft Oil Pad....
59559	22805	" " " " Tube...
58554	22805	" " " " " "
		Joint.....
68350	22805	Oscillating Rock Shaft Oil Tube Oil Cup.....
58560	22805	Oscillating Rock Shaft Oil Tube and Joint complete, Nos. 58554, 58559 and 68350.....
58558	-----	Oscillating Rock Shaft complete, Nos. 1503J, 11165, 51227C, 58550, 58560 and 58595.....
19842	22801	Oscillating Shaft.....
68350	22799	" " Bearing (front) Oil Cup.....
9152	4469	Oscillating Shaft Collar with two 448AL.....
448AL	4469	Oscillating Shaft Collar Set Screw (2).....
19770	-----	Oscillating Shaft Crank with 445C.
8873	4475	" " " Pin.....
445C	4478	" " " Set Screw.
19771	4469	" " " Slide Block.....
19773	4469	Oscillating Shaft Crank Slide Block complete, Nos. 164E, 1156C, 19771 and 19772.....
164E	4469	Oscillating Shaft Crank Slide Block Cap Screw.....
1156C	4469	Oscillating Shaft Crank Slide Block Cap Screw Stud.....
1508E	4469	Oscillating Shaft Crank Slide Block Cap Screw Stud Nut.....
19772	4469	Oscillating Shaft Crank Slide Block Cap Screw Washer.....
19789	4469	Oscillating Shaft Crank complete, Nos. 1508E, 19770 and 19773...
16901	22806	Shuttle Bobbin.....
58207	22806	" Cylinder.....
58271	-----	" " 58207 with 1323F and 58209.....
8777	22806	Shuttle Cylinder Hinge Pin.....
58644	22795	" " Latch.....
43236	22806	" " " Hinge Pin..
58666	22795	" " " Spring.....
58669	22795	Shuttle (cylinder) 4 in. diam., complete, Nos. 8777, 16901, 58271, 58668 and 120571.....
120571	22795	Shuttle (cylinder) Opener.....
19845	4472	" Driver with 445C.....
8873	4475	" " Pin.....
445C	4478	" " Set Screw.....
58667	22795	" Frame.....
58668	-----	" " 58667 with 43236, 58644 and 58666.....
19846	4441	Shuttle Race Back.....

No.	Plate	Name
2049	4475	Shuttle Race Back Position Pin (2)
19847	4441	" " " Spring.....
660D	4477	" " " " Screw....
19848	-----	" " Body.....
19850	22803	" " Frame with 11838....
116D	4476	" " Clamping Screw.
11838	4475	" " " Position Pin...
9122	4472	" " Slide (left) for 19858.....
9121	4472	Shuttle Race Slide (right) for 19858.....
19849	4441	Shuttle Race complete, Nos. 660D, 19846, 19847, 19848 and two 2049.....
134D	4465	Shuttle Race Screw (2).....
1323F	22806	" Tension Regulating Screw..
58209	22806	" " Spring.....
58255	4472	Spool Holder Bracket.....
58256	4472	Spool Holder Bracket complete, Nos. 11881 and 58255.....
1177D	4476	Spool Holder Bracket Screw (2)....
851E	4473	" " Tension Spool Pin with fixed cone.....
8018	4473	Spool Holder Tension Spool Pin Cone.....
1541E	4473	Spool Holder Tension Spool Pin Nut
8019	4473	" " " " " "
11881	-----	Spring.....
11502	4473	Spool Holder Tension Spool Pin complete, Nos. 851E, 1541E, 8018 and 8019.....
11501	-----	Tension Bracket and Vibrating Presser Bar Cap with 11424....
159F	4473	Tension Bracket and Vibrating Presser Bar Cap complete, Nos. 122E, 9525, 11502, 11506, 11936, 11937, 12042 and two 190J.....
145F	4473	Tension Bracket and Vibrating Presser Bar Cap Screw (left)..
8879	22804	Tension Bracket and Vibrating Presser Bar Cap Screw (right).
11423	4473	Tension Friction Washer (felt) (2)
1560C	4473	" " " (steel)....
8905	4473	" Regulating Thumb Nut.....
607E	4473	" " " Wash- er.....
58598	-----	Tension Screw Stud.....
122E	4473	" " " 607E with 1560C
8791	4474	" " Clamping Screw.
11044	4474	" Spring.....
12042	-----	" Wheel.....
11424	4474	Tension (wheel) complete, Nos. 8791, 8905, 11044, 11423, 58598 and two 8879.....
		Thread Eyelet for 11502.....



## PARTS FOR MACHINE No. 7-33

No.	Plate	Name
11950	4474	Thread Eyelet for 11503.....
11495	4468	" " (side of arm).....
190E	4468	" " " " Screw.....
2102	4474	" Retaining Disc (2).....
1560C	4473	" " Regulating Thumb Nut.....
8905	4473	Thread Retaining Regulating Thumb Nut Washer.....
606E	4474	Thread Retaining Screw Stud.....
58597	-----	" " " " 606E with 1560C.....
2103	4474	Thread Retaining Spring.....
11503	-----	Thread Retainer complete, Nos. 2103, 8905, 58597 and two 2102
11505	22803	Thread Take-up Cam with two 434C..
8873	4475	" " " Pin.....
434C	4478	" " " Set Screw (2)..
58332	22807	" " Lever with 1995 and 9219.....
58333	-----	Thread Take-up Lever 58332 with 50437D.....
50437D	4477	Thread Take-up Lever Hinge Screw..
1995	4475	" " " Roller and Screw Stud with 1518E.....
1518E	4465	Thread Take-up Lever Roller and Screw Stud Nut.....
9219	22804	Thread Take-up Lever Thread Eyelet Bushing.....
11506	4474	Thread Take-up Spring.....
11936	4474	" " " Regulator Plate.....
190J	4463	Thread Take-up Spring Regulator Plate Adjusting Screw (2).....
11937	4474	Thread Take-up Spring Staple.....
9525	4474	" " " " Wash- er.....
19853	-----	Throat Plate Body.....
19854	4436	" " Needle Hole Strip....
389F	4476	" " " " " Screw (?).....
1985b	4436	Throat Plate complete, for 19834, Nos. 19853, 19854 and two 389F
19856	-----	Throat Plate Body.....
19857	4437	" " Needle Plate.....
231F	4476	" " " " Screw...
19858	4437	Throat Plate complete, for 19835, Nos. 231F, 19856 and 19857....
Note:		When Throat Plate No. 19858 is used, Shuttle Race Slides Nos. 9121 and 9122 are also required.
381D	4476	Throat Plate Screw (2).....
*15404	-----	Trade Mark.....
15405	-----	" " Rivet (2).....
11508	22807	Vibrating Presser Bar.....
11509	4475	" " " Cushion (rawhide).....

## PARTS FOR MACHINE No. 7-33

No.	Plate	Name
233J	4475	Vibrating Presser Bar Cushion Screw (2).....
58620	22807	Vibrating Presser Bar Hinge Bracket with 145E.....
145E	4473	Vibrating Presser Bar Hinge Bracket Adjusting Screw.....
164D	4469	Vibrating Presser Bar Hinge Cap Screw.....
41544	4475	Vibrating Presser Bar Hinge Cap Screw Washer.....
11512	4475	Vibrating Presser Bar Spring.....
11939	4475	" " " Ad- justing Staple.....
190J	4468	Vibrating Presser Bar Spring Ad- justing Staple Screw.....
223J	4475	Vibrating Presser Bar Spring Screw
19860	4467	" " Foot for 19834..
58262	4467	" " " " 19835..
898D	4476	" " " Screw.....
1547D	22805	" " " " Nut..

SINGER Needles should be used  
in SINGER Machines.  
These Needles and their Containers  
are marked with the  
Company's Trade Mark "SIMANCO.\*\*\*" 1

Needles in Containers marked  
"FOR SINGER MACHINES"  
are NOT **SINGER** made needles. 2

## ACCESSORIES

No.	Plate	Name
11361	22807	Bed Bracket (left) with wood screw 1 in. No. 16 (for machine on top of table) (2).....
11360	22807	Bed Bracket (right) with wood screw 1 in. No. 16 (for machine on top of table) (2)....
507E	4476	Bed Bracket Bolt with 1515E (4)...
1515E	22805	" " " Nut (4).....
120344	4484	Oiler (copper plated) with 120345.
120345	4484	" Spout, 4 1/2 in. long.....
11831	4484	Screw Driver (large).....
26026	4484	" " (small).....
8909	4484	Wrench for 692, 1513 and 50323....
8910	4484	" " 1503.....
8911	4484	" " 1503.....
23535	4484	" " 346, 1528 and 1547.....
124165	22807	" (Allen).....

## BOBBIN WINDER

(SWINGING AUTOMATIC, LEFT HAND)

No.	Plate	Name
41894	4485	Base with 449C.....
894E	4476	" Screw (3).....
60213	22804	Bobbin Position Pin.....
151114	22803	Bracket.....
140370D	22804	" Screw.....
9842	4475	" " Washer.....
41896	4485	Frame.....
41441	4485	" Hinge Pin.....
449C	4478	" " " Set Screw.....
4784	22804	" Oil Pad (felt) (2).....
41897	4485	" Spring.....
43270	4486	Friction Pulley with 43271, two 448AL and ten 26070.....
43271	4486	Friction Pulley Ring (leather)....
26070	22805	" " " Rivet (10)...
448AL	4469	" " " Set Screw (2).....
60214	4486	Spindle.....
454C	4478	" Set Screw.....
60215	4486	" Shaft with 454C and 60213.

No.	Plate	Name
60216	4486	Stop Latch.....
11107	4486	" " Hinge Pin.....
2269	22804	" " Pin.....
41899	4486	Tripping Arm with 176E.....
176E	4476	" " Clamping Screw.....
60217	4485	Bobbin Winder, Nos. 2269, 11107, 41441, 41894, 41896, 41897, 41899, 43270, 60214, 60215, 60216 and two 4784.....

## THREAD UNWINDER PARTS

No.	Plate	Name
225257	22808	Spool Rest with 201018C.....
150203	22808	" " Cushion (felt) (2).....
201018C	22805	" " Set Screw.....
259658	22809	" Stand with 200383C.....
2102	4474	Tension Disc (2).....
1560C	4473	" Regulating Thumb Nut.....
828C	4474	" Screw Stud.....
42418	-----	" " " 828C with 1560C
2103	4474	" Spring.....
5769	4474	" Thread Eyelet.....
17547	4474	" " Guard.....
60608	22808	Thread Guard.....
27560	22808	" " Rod, 26 in. long....
200383C	22805	" " " Set Screw.....
330E	4478	" " Set Screw.....
60609	-----	Thread Guard complete, Nos. 330E, 2103, 5769, 17547, 42418, 60608 and two 2102.....
41823	22808	Thread Unwinder complete, Nos. 27560, 60609, 225257, 259658, two 150203 and three wood screws 1 1/4 in. No. 12 F.H....
151116	-----	Bobbin Winder (swinging automatic, left hand) complete, Nos. 9842, 41823, 60217, 140370D, 151114 and three 894E.....

## NUMERICAL LIST OF PARTS

No.	Plate	Name
16D	4477	Lifting Presser Bar Lifter Hinge Screw.....
65D	4477	Arm Side Cover Hinge Screw.....
116D	4476	Shuttle Race Frame Clamping Screw.....
122E	4473	Tension Screw Stud Clamping Screw for 11501.....
123E	4476	Lifting Presser Bar Rock Shaft Bracket Screw.....
134E	4465	Feed Lifting Rock Shaft Wearing Block Screw for 9225.....
134D	4465	Oil Cup Screw.....
134D	4465	Shuttle Race Screw (2).....
141E	4476	Lifting Presser Bar Rock Shaft Eccentric Strap Adjusting Screw for 11486 (2).....
145E	4473	Lifting Presser Bar Bracket Clamping Screw for 58643 (2).....
145F	4473	Tension Bracket and Vibrating Presser Bar Cap Screw (right).....
145E	4473	Vibrating Presser Bar Hinge Bracket Adjusting Screw for 58620.....
159F	4473	Tension Bracket and Vibrating Presser Bar Cap Screw (left).....
164E	4469	Oscillating Shaft Crank Slide Block Cap Screw for 19773.....
164D	4469	Vibrating Presser Bar Hinge Cap Screw.....
166D	4476	Feed Dog Screw
166D	4476	Lifting Presser Bar Lifting Link Cap Screw.....
176E	4476	Bobbin Winder Tripping Arm Clamping Screw for 41899.....
190E	4468	Thread Eyelet (side of arm) Screw.....
190J	4468	Thread Take-up Spring Regulator Plate Adjusting Screw for 11501 (2).....
190J	4468	Vibrating Presser Bar Spring Adjusting Staple Screw.....
207F	4468	Oil Cup Cover Latch Spring Screw for 58254.....
207F	4468	Oil or Wax Stripper Screw for 58254 (2).....
223J	4475	Vibrating Presser Bar Spring Screw
231F	4476	Throat Plate Needle Plate Screw for 19858.....
233J	4475	Vibrating Presser Bar Cushion Screw (2).....
258E	4477	Lifting Presser Bar Screw Bushing.
258E	4477	Needle Bar Screw Bushing.....
294C	4478	Feed Lifting Rock Shaft Screw Center (right).....

SINGER Needles should be used  
in SINGER Machines.  
These Needles and their Containers  
are marked with the  
Company's Trade Mark "SIMANCO.\*\*\*" 1

Needles in Containers marked  
"FOR SINGER MACHINES"  
are NOT **SINGER** made needles. 2

## NUMERICAL LIST OF PARTS

No.	Plate	Name
294C	4478	Feed Rock Shaft Screw Center (right).....
330E	4478	Thread Unwinder Thread Guard Set Screw for 60609.....
346E	4465	Feed Rock Shaft Crank Clamping Screw for 58235.....
350C	22799	Balance Wheel Set Screw for 58677 (2).....
381D	4476	Throat Plate Screw (2).....
389F	4476	Throat Plate Needle Hole Strip Screw for 19855 (2).....
434C	4478	Thread Take-up Cam Set Screw for 11505 (2).....
437C	4478	Arm Shaft Bushing Set Screw.....
445C	4478	Feed Cam Set Screw for 11367 (2)..
445F	4478	Needle Bar Connecting Stud Set Screw for 11383 (2).....
445C	4478	Oscillating Shaft Crank Set Screw for 19770.....
445C	4478	Shuttle Driver Set Screw for 19845
448AL	4469	Bobbin Winder Friction Pulley Set Screw for 43270 (2).....
448AL	4469	Oscillating Shaft Collar Set Screw for 9152 (2).....
449C	4478	Bobbin Winder Frame Hinge Pin Set Screw for 41894.....
453AL	4466	Lifting Presser Bar Rock Shaft Adjusting Arm Set Screw for 58578.....
453AL	4466	Lifting Presser Bar Rock Shaft Crank Set Screw for 11484.....
454C	4478	Bobbin Winder Spindle Set Screw for 60215.....
507E	4476	Bed Bracket Bolt with 1515E (Accessories) (4).....
565C	4476	Feed Connecting Link Hinge Screw..
565C	4476	Feed Forked Connection Hinge Screw (2).....
566C	4468	Needle Bar Connecting Link Hinge Screw.....
568E	4477	Feed Regulator Hinge Screw.....
575E	4476	Crank Connecting Rod Cap Screw for 19758 (2).....
606E	4474	Thread Retaining Screw Stud for 58597.....
607E	4473	Tension Screw Stud for 58598.....
608C	4466	Lifting Presser Bar Rock Shaft Eccentric Strap Hinge Screw...
610E	4465	Lifting Presser Bar Bell Crank Slide Block Screw for 58621...
660D	4477	Shuttle Race Back Spring Screw for 19849.....
680F	4468	Needle Clamp Thumb Screw for 19702
692D	22799	Feed Lifting Rock Shaft Crank Clamping Screw for 19837.....
828C	4474	Thread Unwinder Tension Screw Stud for 42418.....

## NUMERICAL LIST OF PARTS

No.	Plate	Name
851E	4473	Spool Holder Tension Spool Pin with fixed cone for 11881.....
885D	4477	Guide Thumb Screw.....
894E	4476	Bobbin Winder Base Screw for 151116 (3).....
898D	4476	Vibrating Presser Foot Screw.....
949E	22799	Arm Shaft Screw.....
1015C	4478	Feed Lifting Rock Shaft Screw Center (left).....
1015C	4478	Feed Rock Shaft Screw Center (left)
1151C	4476	Crank Connecting Rod Hinge Screw..
1156C	4469	Oscillating Shaft Crank Slide Block Cap Screw Stud for 19773.....
1177D	4476	Lifting Presser Bar Spring Bracket Screw.....
1177D	4476	Spool Holder Bracket Screw (2)....
1259AL	4478	Lifting Presser Foot Set Screw for 58260 and 58261.....
1323F	22806	Shuttle Tension Regulating Screw for 58271.....
1503E	4478	Feed Lifting Rock Shaft Screw Center (left) Nut.....
1503E	4478	Feed Lifting Rock Shaft Screw Center (right) Nut.....
1503E	4478	Feed Rock Shaft Screw Center (left) Nut.....
1503E	4478	Feed Rock Shaft Screw Center (right) Nut.....
1503J	4478	Oscillating Rock Shaft Hinge Pin Nut for 58595.....
1503J	4478	Oscillating Rock Shaft Hinge Pin Screw Bearing Nut for 58558...
1508E	4469	Oscillating Shaft Crank Slide Block Cap Screw Stud Nut for 19789..
1513J	22799	Feed Bar Screw Center Nut for 58338 (2).....
1513J	22799	Feed Connecting Link Hinge Screw Nut.....
1513J	22799	Feed Forked Connection Hinge Screw Nut (2).....
1513J	22799	Needle Bar Connecting Link Hinge Screw Nut.....
1515E	22805	Bed Bracket Bolt Nut for 507E (4)..
1518E	4465	Lifting Presser Bar Bell Crank Slide Block Screw Nut.....
1518E	4465	Lifting Presser Bar Rock Shaft Eccentric Strap Hinge Screw Nut
1518E	4465	Thread Take-up Lever Roller and Screw Stud Nut for 1995.....
1528C	22805	Lifting Presser Bar Rock Shaft Eccentric Strap Adjusting Screw Nut for 11486 (2).....
1541E	4473	Spool Holder Tension Spool Pin Nut for 11881.....
1547D	22805	Vibrating Presser Foot Screw Nut..

No.	Plate	Name
1560C	4473	Tension Regulating Thumb Nut for 58598.....
1560C	4473	Thread Retaining Regulating Thumb Nut for 58597.....
1560C	4473	Thread Unwinder Tension Regulating Thumb Nut for 42418.....
1646E	22799	Crank Connecting Rod Hinge Screw Nut.....
1850	4466	Lifting Presser Bar Rock Shaft Crank Roller and Stud for 11484
1861	4475	Feed Lifting Rock Shaft Crank Roller and Stud for 19837.....
1995	4475	Thread Take-up Lever Roller and Screw Stud with 1518E, for 58332.....
2002	4475	Lifting Presser Bar Rock Shaft Bracket Dowel Pin (lower).....
2022	4465	Feed Lifting Rock Shaft Wearing Block Position Pin for 9225....
2049	4475	Shuttle Race Back Position Pin for 19849 (2).....
2102	4474	Thread Retaining Disc for 11503 (2).....
2102	4474	Thread Unwinder Tension Disc for 60609 (2).....
2103	4474	Thread Retaining Spring for 11503.
2103	4474	Thread Unwinder Tension Spring for 60609.....
2205	4468	Oil Cup Cover Latch Spring for 58254.....
2269	22804	Bobbin Winder Stop Latch Pin for 60217.....
2718	4465	Lifting Presser Bar Bell Crank Slide Block Screw Nut Washer..
4389	4475	Lifting Presser Bar Rock Shaft Bracket Dowel Pin (upper).....
4389	4475	Lifting Presser Bar Spring Guide Pin.....
4784	22804	Bobbin Winder Frame Oil Pad (felt) for 60217 (2).....
5769	4474	Thread Unwinder Tension Thread Eyelet for 60609.....
8018	4473	Spool Holder Tension Spool Pin Cone for 11881.....
8019	4473	Spool Holder Tension Spool Pin Spring for 11881.....
8482	4468	Oil or Wax Stripper Washer (steel) for Oil Cup for 58254.....
8702	4475	Arm Dowel Pin (2).....
8760	4465	Lifting Presser Bar Lifter Friction Washer.....
8761	4465	Lifting Presser Bar Lifter Stop Pin for 11909.....
8763	4465	Lifting Presser Bar Lifting Link Hinge Stud for 11909.....

No.	Plate	Name
8777	22806	Shuttle Cylinder Hinge Pin for 58669.....
8791	4474	Tension Spring for 12042.....
8873	4475	Oscillating Shaft Crank Pin.....
8873	4475	Shuttle Driver Pin.....
8873	4475	Thread Take-up Cam Pin.....
8879	22804	Tension Friction Washer (felt) for 12042 (2).....
8905	4473	Tension Regulating Thumb Nut Washer for 12042.....
8905	4473	Thread Retaining Regulating Thumb Nut Washer for 11503.....
8909	4484	Wrench for 692, 1513 and 50323 (Accessories).....
8910	4484	Wrench for 1508 (Accessories).....
8911	4484	Wrench for 1503 (Accessories).....
8953	4468	Oil or Wax Stripper (felt) for 58254 (2).....
8973	4465	Lifting Presser Bar Lifting Link Hinge Stud Pin.....
9084	4468	Oil Cup Cover Hinge Pin for 58254.
9121	4472	Shuttle Race Slide (right) for 19858.....
9122	4472	Shuttle Race Slide (left) for 19858.....
9152	4469	Oscillating Shaft Collar with two 448AL.....
9219	22804	Thread Take-up Lever Thread Eyelet Bushing for 58332.....
9225	22801	Feed Lifting Rock Shaft with 134E, 2022 and 19967, for 58288.....
9525	4474	Thread Take-up Spring Staple Washer for 11501.....
9842	4475	Bobbin Winder Bracket Screw Washer for 151116.....
11044	4474	Tension Wheel for 12042.....
11107	4486	Bobbin Winder Stop Latch Hinge Pin for 60217.....
11165	4469	Oscillating Rock Shaft Oil Pad for 58558.....
11354	4463	Arm Shaft Bushing.....
11360	22807	Bed Bracket (right) with wood screw 1 in. No. 16 (for machine on top of table) Accessories (2).....
11361	22807	Bed Bracket (left) with wood screw 1 in. No. 16 (for machine on top of table) Accessories (2).....
11365	4464	Feed Bar.....
11367	4463	Feed Cam with two 445C.....
11368	4465	Feed Connecting Link.....
11375	4464	Feed Regulator.....
11383	4468	Needle Bar Connecting Stud with two 445F for 19981.....
11385	4468	Needle Clamp Gib for 19702.....
11423	4473	Tension Friction Washer (steel) for 12042.....

No.	Plate	Name
11424	4474	Thread Eyelet for 11502.....
11479	4466	Lifting Presser Bar Rock Shaft for 58245.....
11481	4463	Lifting Presser Bar Rock Shaft Bracket for 58245.....
11484	4466	Lifting Presser Bar Rock Shaft Crank with 453AL and 1850.....
11486	22802	Lifting Presser Bar Rock Shaft Eccentric Strap with two each 141E and 1528C.....
11487	4466	Lifting Presser Bar Rock Shaft Eccentric Strap Hinge Screw Slide.....
11488	4466	Lifting Presser Bar Rock Shaft Eccentric Strap Hinge Screw Slide Washer.....
11489	4466	Lifting Presser Bar Sleeve (lower)
11490	4466	Lifting Presser Bar Sleeve (upper)
11492	4466	Lifting Presser Bar Sleeve (upper) Cap.....
11493	22801	Lifting Presser Bar Spring (flat).
11495	4468	Thread Eyelet (side of arm).....
11501	-----	Tension Bracket and Vibrating Presser Bar Cap complete, Nos. 122E, 952S, 11502, 11506, 11936, 11937, 12042 and two 190J.....
11502	4473	Tension Bracket and Vibrating Presser Bar Cap with 11424, for 11501.....
11503	-----	Thread Retainer complete, Nos. 2103, 8905, 58597 and two 2102
11505	22803	Thread Take-up Cam with two 434C..
11506	4474	Thread Take-up Spring for 11501...
11508	22807	Vibrating Presser Bar.....
11509	4475	Vibrating Presser Bar Cushion (rawhide).....
11512	4475	Vibrating Presser Bar Spring.....
11538	4464	Needle Bar.....
11539	4468	Needle Bar Connecting Link for 19981.....
11831	4484	Screw Driver (large) Accessories..
11838	4475	Shuttle Race Frame Position Pin for 19850.....
11881	-----	Spool Holder Tension Spool Pin complete for 58256, Nos. 851E, 1541E, 8018 and 8019....
11907	4463	Lifting Presser Bar Lifting Link..
11909	4464	Lifting Presser Bar Lifter with 8761 and 8763.....
11913	22802	Arm Side Cover.....
11917	-----	Oil Cup Cover for 58254.....
11918	4468	Oil or Wax Stripper Washer (steel) for Cover, for 58254.....
11936	4474	Thread Take-up Spring Regulator Plate for 11501.....

No.	Plate	Name
11937	4474	Thread Take-up Spring Staple for 11501.....
11939	4475	Vibrating Presser Bar Spring Adjusting Staple.....
11950	4474	Thread Eyelet for 11503.....
12042	-----	Tension (wheel) complete for 11501 Nos. 8791, 8905, 11044, 11423, 58598 and two 8879.....
*15404	-----	Trade Mark for 58257.....
15405	-----	Trade Mark Rivet for 58257 (2)....
16901	22806	Shuttle Bobbin for 58669.....
17547	4474	Thread Unwinder Tension Thread Guard for 60609.....
19702	4468	Needle Clamp with 680F and 11385..
19758	22801	Crank Connecting Rod with two 575E
19762	22801	Feed Forked Connection.....
19770	-----	Oscillating Shaft Crank with 445C, for 19789.....
19771	4469	Oscillating Shaft Crank Slide Block for 19773.....
19772	4469	Oscillating Shaft Crank Slide Block Cap Screw Washer for 19773.....
19773	4469	Oscillating Shaft Crank Slide Block complete for 19789, Nos. 164E, 1156C, 19771 and 19772.....
19789	4469	Oscillating Shaft Crank complete, Nos. 1508E, 19770 and 19773...
*19832	-----	Bed.....
19834	4436	Feed Dog (double).....
	Note:	No. 19834 is regularly furnished with this machine.
19835	4437	Feed Dog (single).....
19837	4463	Feed Lifting Rock Shaft Crank with 692D and 1861, for 58288.....
19842	22801	Oscillating Shaft.....
19845	4472	Shuttle Driver with 445C.....
19846	4441	Shuttle Race Back for 19849.....
19847	4441	Shuttle Race Back Spring for 19849
19848	-----	Shuttle Race Body for 19849.....
19849	4441	Shuttle Race complete, Nos. 660D, 19846, 19847, 19848 and two 2049.....
19850	22803	Shuttle Race Frame with 11838.....
19853	-----	Throat Plate Body for 19855.....
19854	4436	Throat Plate Needle Hole Strip for 19855.....
19855	4436	Throat Plate complete for 19834, Nos. 19853, 19854 and two 389F.
19856	-----	Throat Plate Body for 19858.....
19857	4437	Throat Plate Needle Plate for 19858.....
19858	4437	Throat Plate complete for 19835, Nos. 231F, 19856 and 19857....
	Note:	When Throat Plate No. 19858 is used, Shuttle Race Slides Nos. 9121 and 9122 are also required.

No.	Plate	Name
19860	4467	Vibrating Presser Foot for 19834..
19923	22801	Arm Shaft.....
19967	22802	Feed Lifting Rock Shaft Wearing Block for 9225.....
19981	-----	Needle Bar Connecting Stud 11383 with 11539.....
23535	4484	Wrench for 346, 1528 and 1547 (Accessories).....
24131	22799	Feed Rock Shaft Back Bearing Oil Tube with 52045.....
26026	4484	Screw Driver (small) Accessories..
26070	22805	Bobbin Winder Friction Pulley Ring Rivet for 43270 (2).....
26419	4463	Guide (6 in. face) for 19858.....
27560	22808	Thread Unwinder Thread Guard Rod, 26 in. long, for 41823.....
36114	4456	Guide (6 in. face) for 19855.....
41441	4485	Bobbin Winder Frame Hinge Pin for 60217.....
41544	4475	Vibrating Presser Bar Hinge Cap Screw Washer.....
41823	22808	Thread Unwinder complete for 151116, Nos. 27560, 60609, 225257, 259658, two 150203, and three wood screws 1 1/4 in. No. 12 F.H.....
41894	4485	Bobbin Winder Base with 449C, for 60217.....
41896	4485	Bobbin Winder Frame for 60217.....
41897	4485	Bobbin Winder Frame Spring for 60217.....
41899	4486	Bobbin Winder Tripping Arm with 176E, for 60217.....
42418	-----	Thread Unwinder Tension Screw Stud 828C with 1560C, for 60609....
43236	22806	Shuttle Cylinder Latch Hinge Pin for 58668.....
43267	4465	Lifting Presser Bar Lifting Link Hinge Stud Washer.....
43270	4486	Bobbin Winder Friction Pulley with 43271, two 448AL and ten 26070, for 60217.....
43271	4486	Bobbin Winder Friction Pulley Ring (leather) for 43270.....
49095	22799	Arm Shaft Screw Washer.....
50083AL	22804	Lifting Presser Bar Bell Crank Hinge Stud Set Screw.....
50322D	4477	Feed Regulator Thumb Screw.....
50323D	22804	Lifting Presser Bar Spring Regulating Thumb Screw.....
50348E	22799	Arm Screw (4).....
50358C	4478	Feed Bar Screw Center for 58338 (2).....
50437D	4477	Thread Take-up Lever Hinge Screw for 58333.....

No.	Plate	Name
51227C	22805	Oscillating Rock Shaft Hinge Pin Screw Bearing for 58558.....
51464F	22799	Cloth Plate Screw.....
52045	22799	Feed Lifting Rock Shaft Front Bearing Oil Tube Packing (cotton) for 58549.....
52045	22799	Feed Rock Shaft Back Bearing Oil Tube Packing (cotton) for 24131
58207	22806	Shuttle Cylinder for 58271.....
58209	22806	Shuttle Tension Spring for 58271..
58222	22803	Cloth Plate.....
58235	4465	Feed Rock Shaft Crank with 346E, for 58244.....
58243	22801	Feed Rock Shaft for 58244.....
58244	-----	Feed Rock Shaft complete, Nos. 58235 and 58243.....
58245	-----	Lifting Presser Bar Rock Shaft Bracket 11481 with 11479, 11484, 58578 and 58656.....
58252	4463	Lifting Presser Bar Spring Bracket
58254	22803	Oil Cup complete, Nos. 2205, 8482, 9084, 11917, 11918, two 8953 and three 207F.....
58255	4472	Spool Holder Bracket for 58256....
58256	4472	Spool Holder Bracket complete, Nos. 11881 and 58255.....
*58257	-----	Arm with 15404 and two 15405.....
58258	4464	Lifting Presser Bar.....
58260	4467	Lifting Presser Foot with 1259AL, for 19834.....
58261	4467	Lifting Presser Foot with 1259AL, for 19835.....
58262	4467	Vibrating Presser Foot for 19835..
58271	-----	Shuttle Cylinder 58207 with 1323F and 58209, for 58669.....
58288	-----	Feed Lifting Rock Shaft complete, Nos. 9225 and 19837.....
58332	22807	Thread Take-up Lever with 1995 and 9219 for 58333.....
58333	-----	Thread Take-up Lever 58332 with 50437D.....
58338	-----	Feed Bar Screw Center 50358C with 1513J (2).....
58548	22799	Arm Oil Tube for oiling Arm Shaft (intermediate) Bearing.....
58549	22799	Feed Lifting Rock Shaft Front Bearing Oil Tube with 52045...
58550	22803	Oscillating Rock Shaft for 58558..
58552	22802	Oscillating Rock Shaft Hinge Pin for 58595.....
58554	22805	Oscillating Rock Shaft Oil Tube Joint for 58560.....
58558	-----	Oscillating Rock Shaft complete, Nos. 1503J, 11165, 51227C, 58550, 58560 and 58595.....

## NUMERICAL LIST OF PARTS

No.	Plate	Name
58559	22805	Oscillating Rock Shaft Oil Tube For 58560.....
58560	22805	Oscillating Rock Shaft Oil Tube and Joint complete, Nos. 58554, 58559 and 68350, for 58558....
58561	22799	Feed Rock Shaft Front Bearing Oil Tube.....
58578	22802	Lifting Presser Bar Rock Shaft Adjusting Arm with 453AL, for 58245.....
58595	-----	Oscillating Rock Shaft Hinge Pin 58552 with 1503J, for 58558....
58597	-----	Thread Retaining Screw Stud 606E with 1560C, for 11503.....
58598	-----	Tension Screw Stud 607E with 1560C, for 12042.....
58617	22802	Lifting Presser Bar Bell Crank....
58618	22804	Lifting Presser Bar Bell Crank Hinge Stud.....
58619	22804	Lifting Presser Bar Bell Crank Slide Block for 58621.....
58620	22807	Vibrating Presser Bar Hinge Bracket with 145E.....
58621	-----	Lifting Presser Bar Bell Crank Slide Block 58619 with 610E....
58643	22802	Lifting Presser Bar Bracket with two 145E.....
58644	22795	Shuttle Cylinder Latch for 58668..
58656	22804	Lifting Presser Bar Rock Shaft Adjusting Arm Pin for 58245....
58656	22804	Lifting Presser Bar Rock Shaft Crank Pin for 58245.....
58666	22795	Shuttle Cylinder Latch Spring for 58668.....
58667	22795	Shuttle Frame for 58668.....
58668	-----	Shuttle Frame 58667 with 43236, 58644 and 58666, for 58669....
58669	22795	Shuttle (Cylinder) 4 in. diam., complete, Nos. 8777, 16901, 58271, 58668 and 120571.....
58677	22800	Balance Wheel (10 in. diam.) 1/2 in. "V" belt groove, with two 350C.....
60213	22804	Bobbin Winder Bobbin Position Pin for 60215.....
60214	4486	Bobbin Winder Spindle for 60217...
60215	4486	Bobbin Winder Spindle Shaft with 454C and 60213, for 60217.....
60216	4486	Bobbin Winder Stop Latch for 60217
60217	4485	Bobbin Winder for 151116, Nos. 2269, 11107, 41441, 41894, 41896, 41897, 41899, 43270, 60214, 60215, 60216 and two 4784.....
60608	22808	Thread Unwinder Thread Guard for 60609.....

## NUMERICAL LIST OF PARTS

No.	Plate	Name
60609	-----	Thread Unwinder Thread Guard complete for 41823, Nos. 330E, 2103, 5769, 17547, 42418, 60608 and two 2102.....
68350	22799	Arm Shaft Bearing (back and front) Oil Cup (2).....
68350	22805	Oscillating Rock Shaft Oil Tube Oil Cup for 58560.....
68350	22799	Oscillating Shaft Bearing (front) Oil Cup.....
120344	4484	Oiler (copper plated) with 120345 (Accessories).....
120345	4484	Oiler Spout, 4 1/2 in. long, for 120344.....
120571	22795	Shuttle (cylinder) Opener for 58669.....
124165	22807	Wrench (Allen) Accessories.....
140370D	22804	Bobbin Winder Bracket Screw for 151118.....
150203	22808	Thread Unwinder Spool Rest Cushion (felt) for 41823 (2).....
151114	22803	Bobbin Winder Bracket for 151116..
151116	-----	Bobbin Winder (swinging automatic, left hand) complete, Nos. 9842, 41823, 60217, 140370D, 151114 and three 894E.....
200383C	22805	Thread Unwinder Thread Guard Rod Set Screw for 202490.....
201018C	22805	Thread Unwinder Spool Rest Set Screw for 225257.....
225257	22808	Thread Unwinder Spool Rest with 201018C, for 41823.....
259658	22808	Thread Unwinder Spool Stand with 200383C, for 41823.....

SINGER Needles should be used  
in SINGER Machines.  
These Needles and their Containers  
are marked with the  
Company's Trade Mark "SIMANCO.\*\*\*" 1

Needles in Containers marked  
"FOR SINGER MACHINES"  
are NOT **SINGER** made needles. 2



PLATE 4436—FULL SIZE

19855

19854

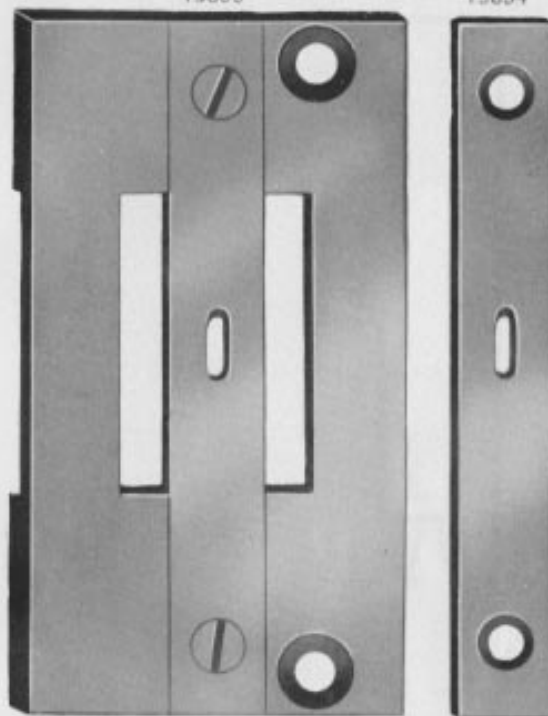

19834

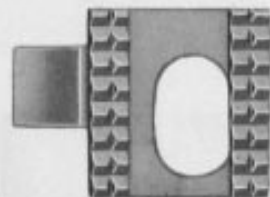
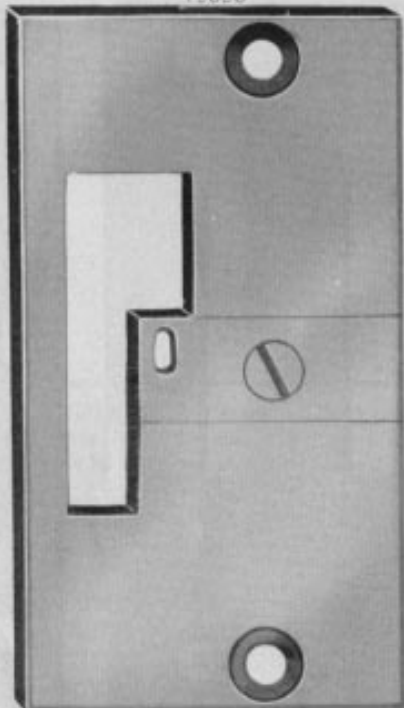
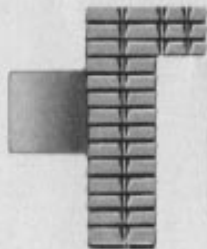

PLATE 4437—FULL SIZE

19858



19835



19857



PLATE 4441—ONE-HALF SIZE

19849

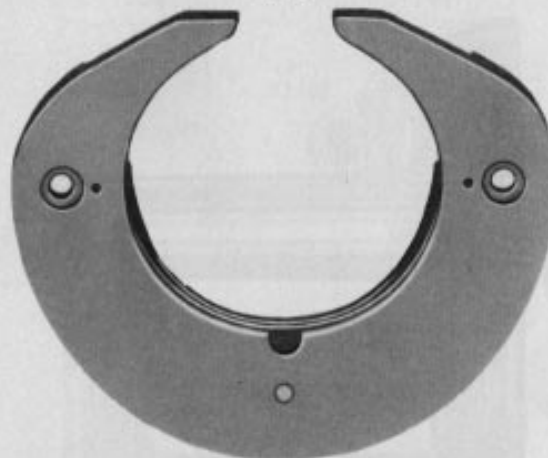

19846



19847



PLATE 4456—ONE-HALF SIZE

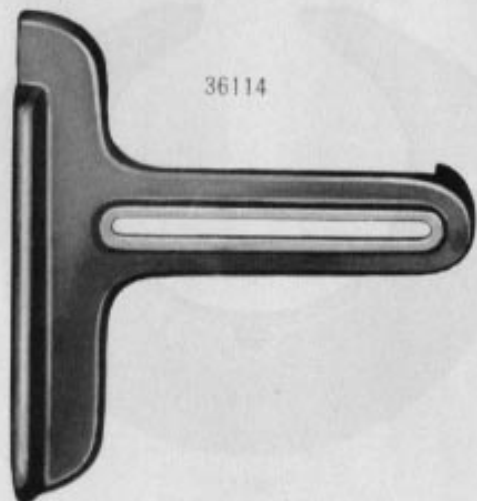

PLATE 4463—ONE-HALF SIZE

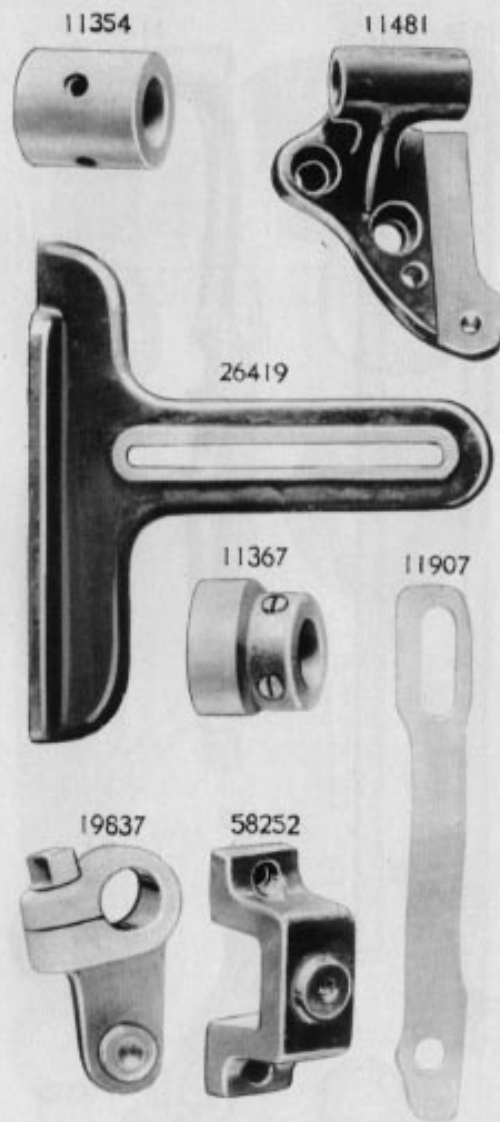

PLATE 4464—ONE-HALF SIZE

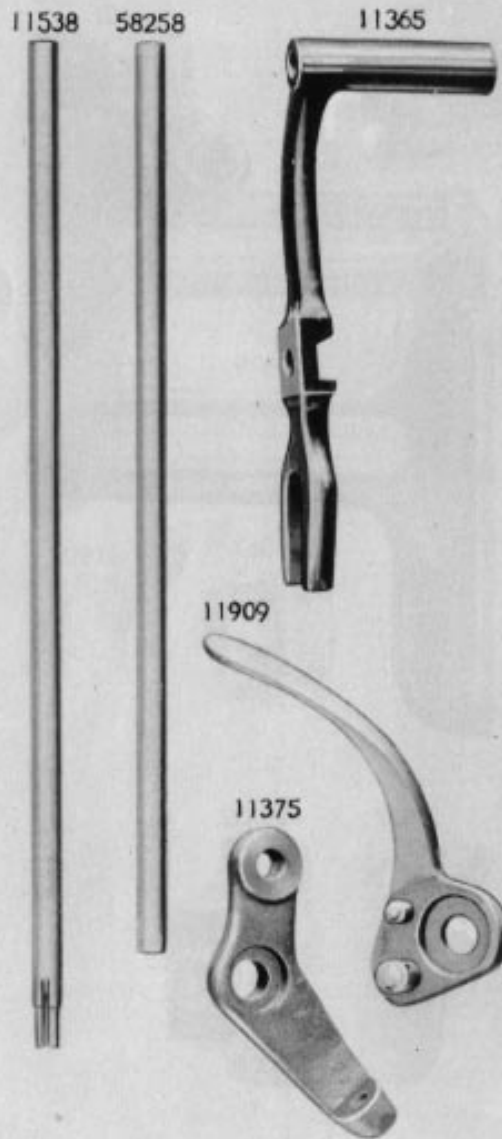

PLATE 4465—FULL SIZE

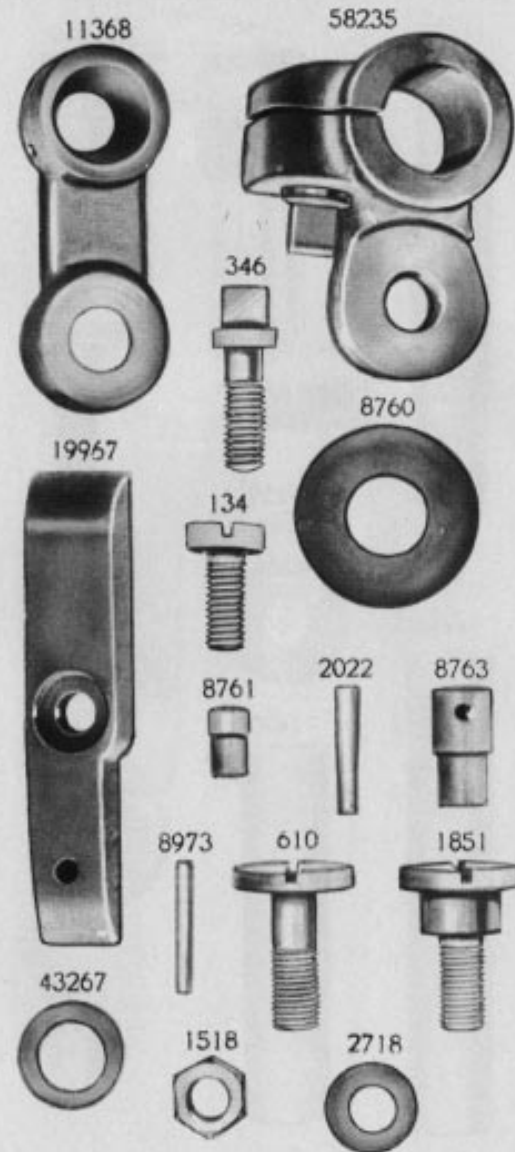

PLATE 4466—FULL SIZE

11479



11484



1850



453



608



58259



11489



11490



11487



11488



11492



PLATE 4467—FULL SIZE

19860

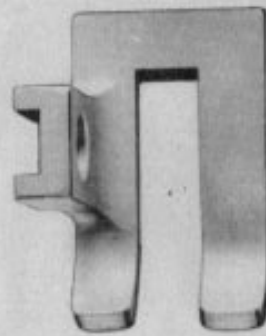

58260



58262

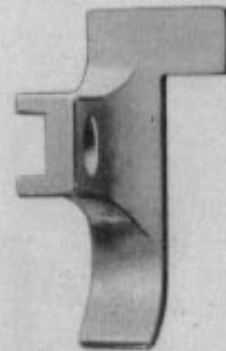

58261

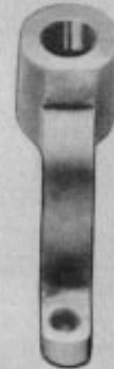

PLATE 4468—FULL SIZE

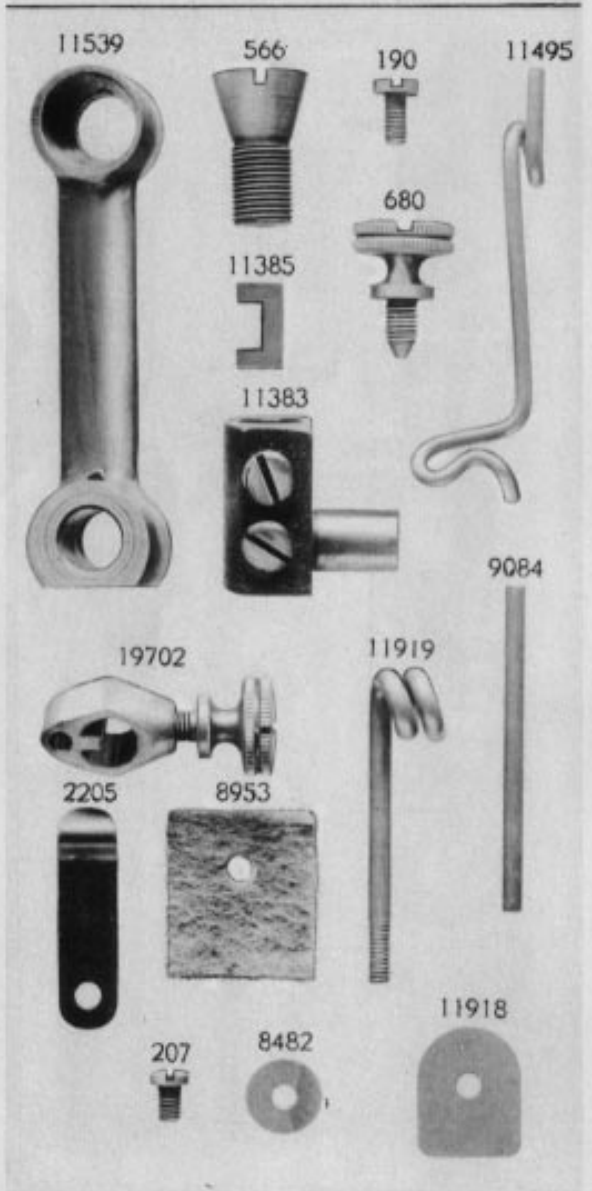

PLATE 4469—FULL SIZE

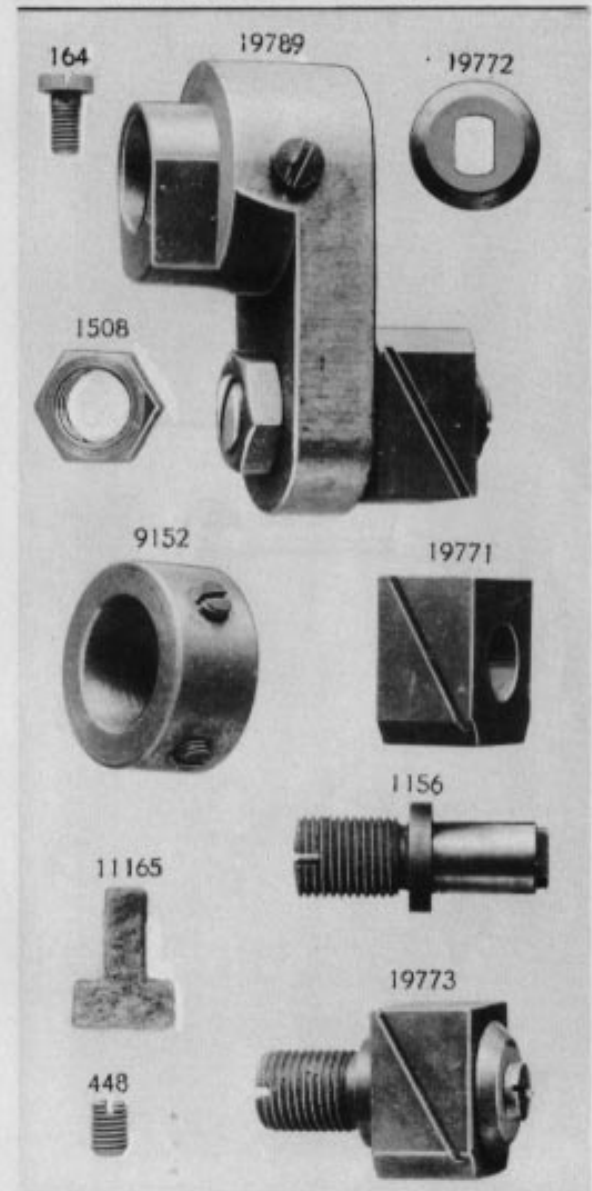

PLATE 4472—ONE-HALF SIZE

9121



9122



58256

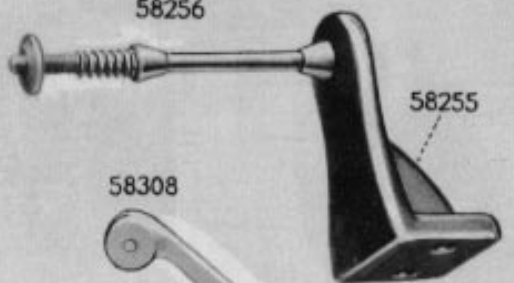

58255

58308

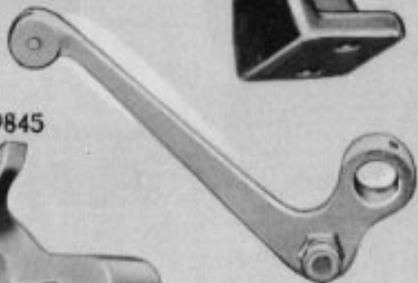

19845



PLATE 4473—FULL SIZE

145



159



11502

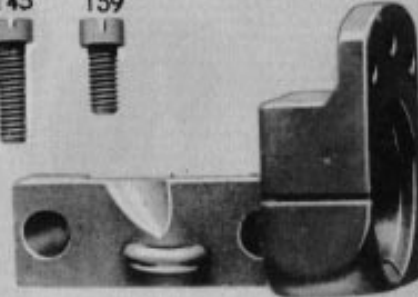

851

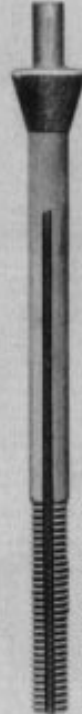

8018



5983

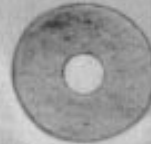

8019



1541



607



122



8905



11423

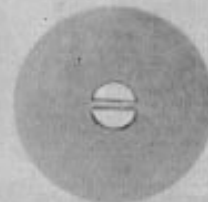

1560



PLATE 4474—FULL SIZE

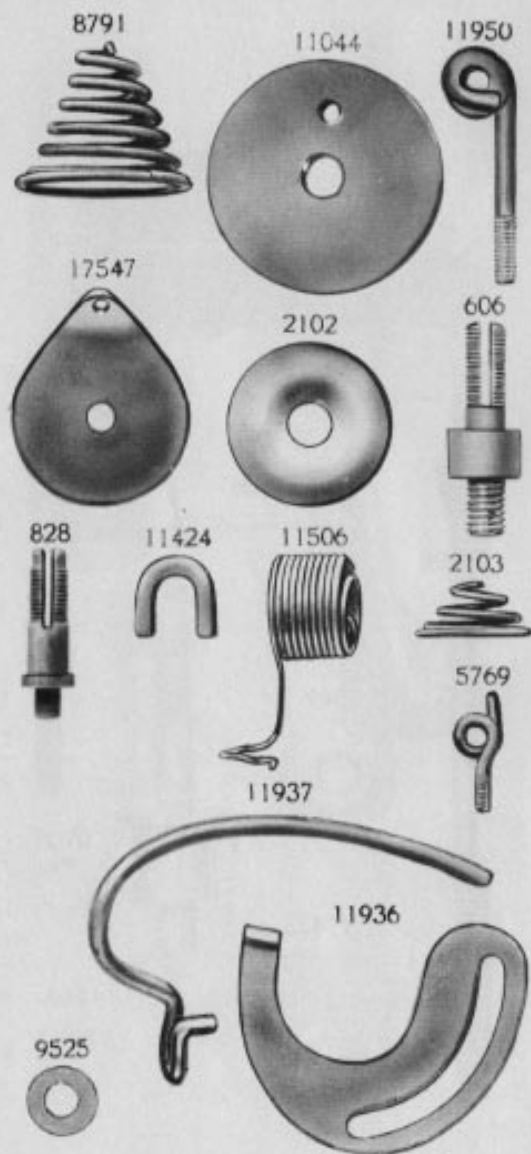

PLATE 4475—FULL SIZE

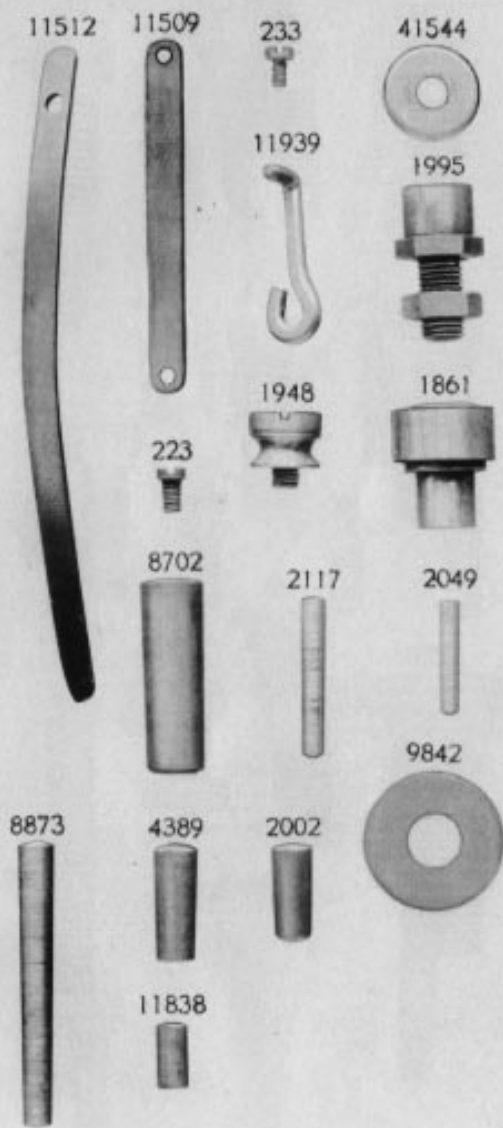



PLATE 4476—FULL SIZE

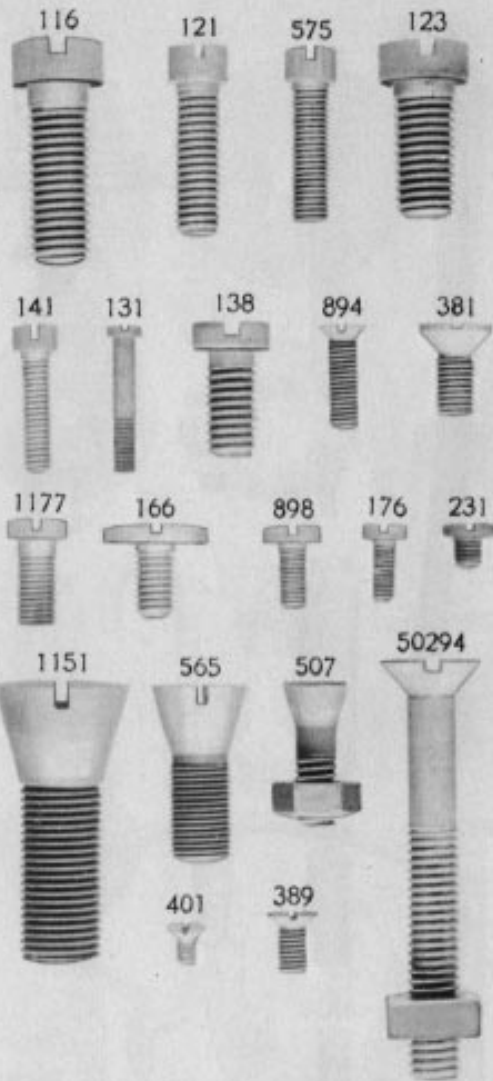

PLATE 4477—FULL SIZE

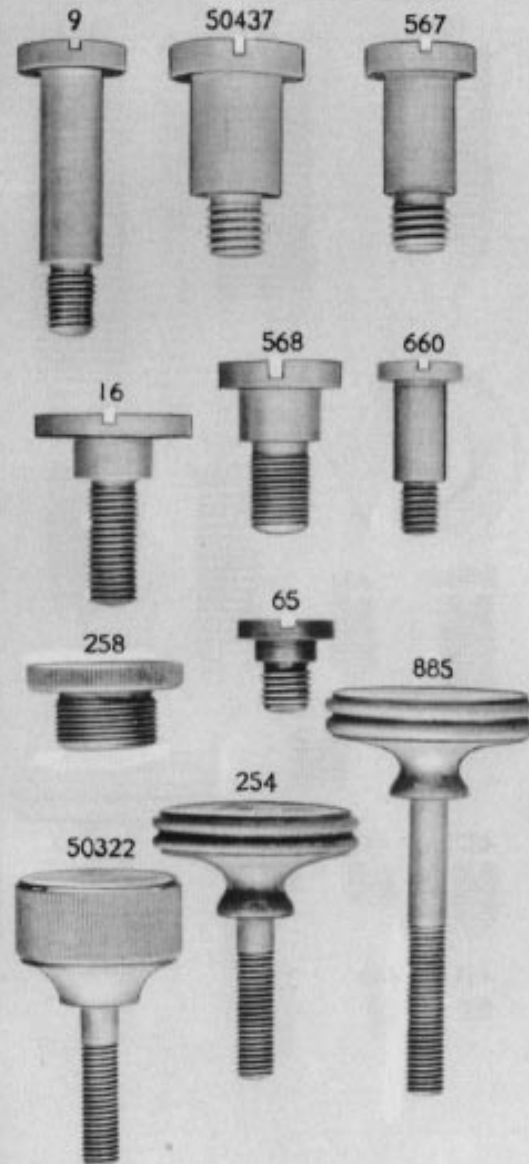

PLATE 4478—FULL SIZE

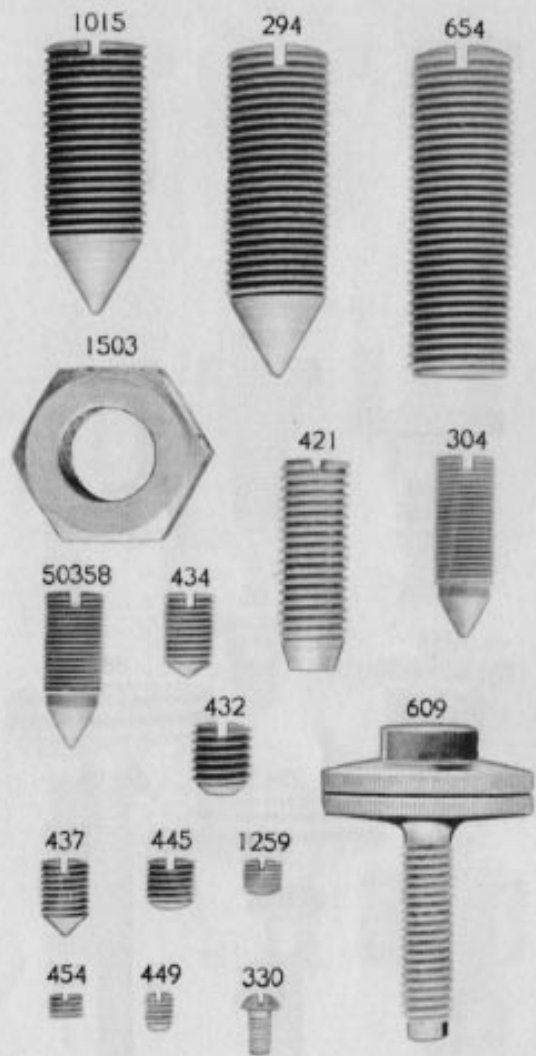

PLATE 4484—ONE-HALF SIZE



PLATE 4485—ONE-HALF SIZE

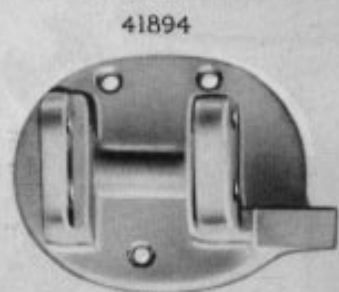
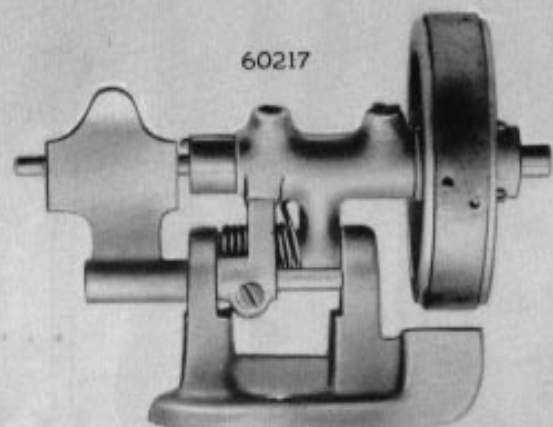

PLATE 4486—ONE-HALF SIZE

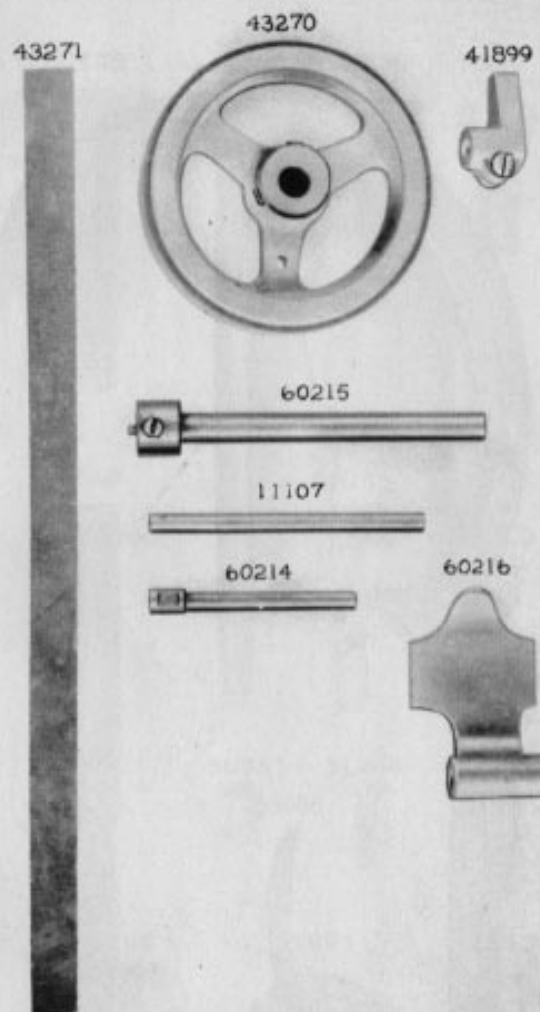
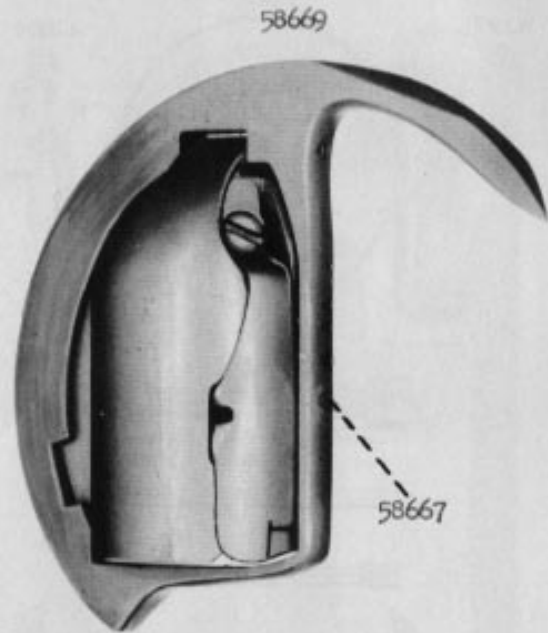

PLATE 22795 - FULL SIZE



120571



58666



58644



PLATE 22799 - FULL SIZE

50348



692



350



949



58548



24131



52045



68350



58561



51464



58549



1646



49095



1513



PLATE 22800—ONE-EIGHTH SIZE

58677



PLATE 22801—ONE-QUARTER SIZE

19923 58243

11493

19762

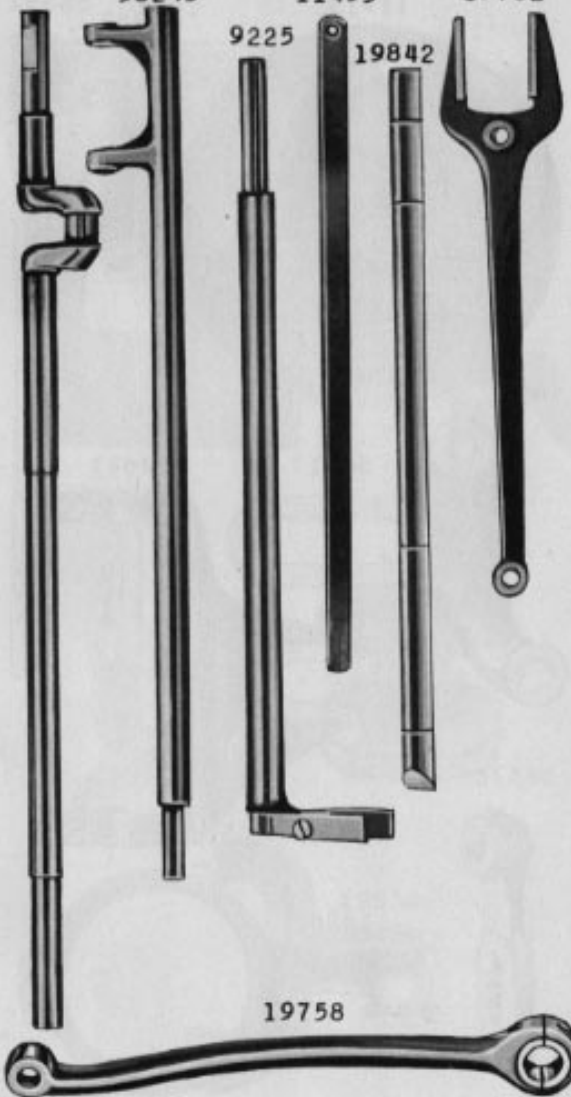

PLATE 22802—ONE-HALF SIZE

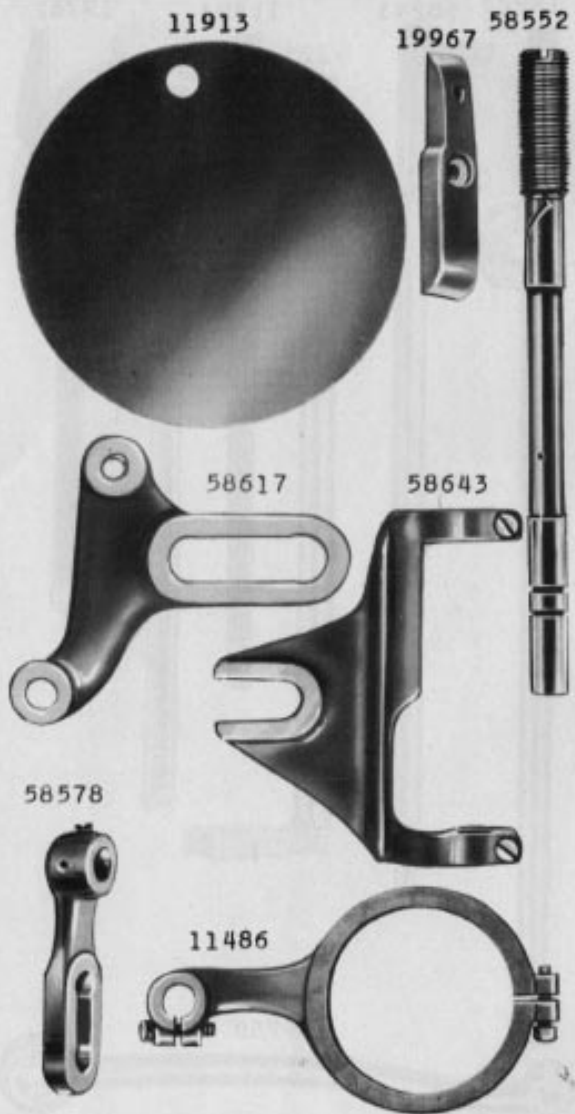

PLATE 22803—ONE-QUARTER SIZE

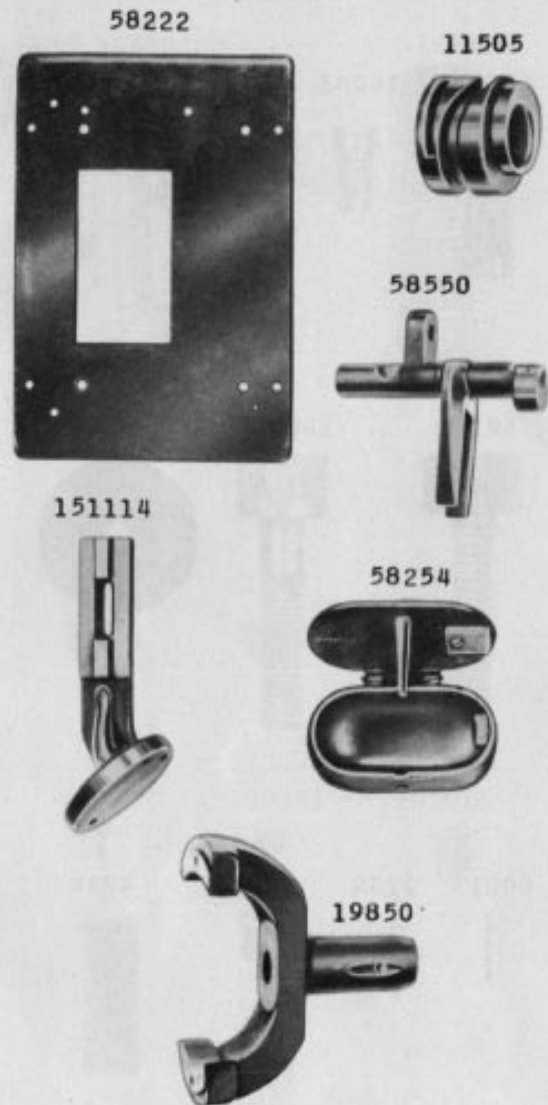

PLATE 22804-FULL SIZE

58618



50083



58619



58656



50323



140370



8879



60213



2269



9219



4784



PLATE 22805-FULL SIZE

58560

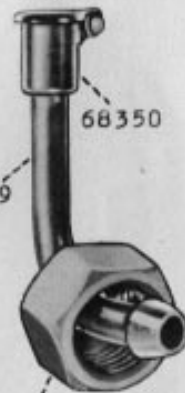

51227



1528



1547



1515



26070



200383



201018



PLATE 22806—FULL SIZE

16901



58207



58209



1323



8777



43236



PLATE 22807—ONE-HALF SIZE

11508



58620



124165

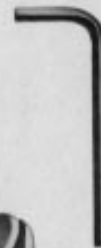

58332

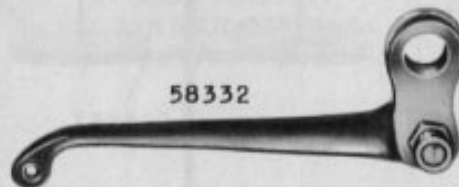

11361



11360





PLATE 22808—ONE-SIXTH SIZE

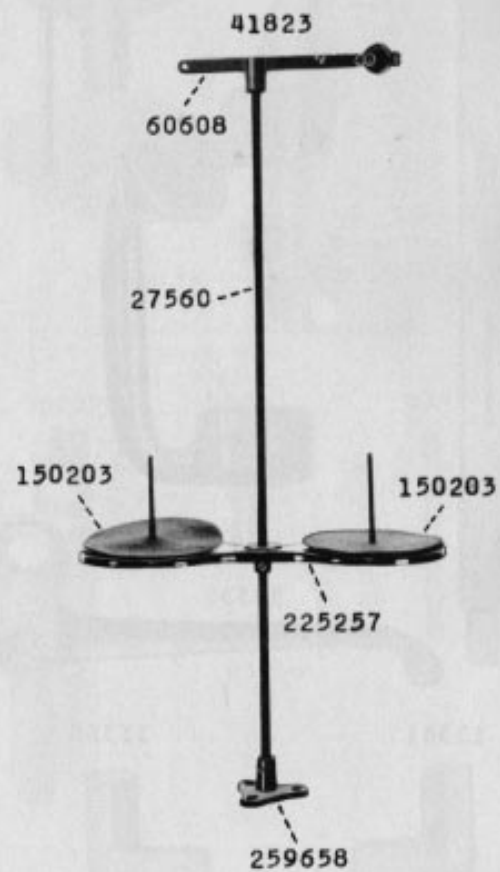

SINGER Needles should be used  
in SINGER Machines.  
These Needles and their Containers  
are marked with the  
Company's Trade Mark "SIMANCO."\*\* 1

Needles in Containers marked  
"FOR SINGER MACHINES"  
are NOT **SINGER** made needles. 2