

# **INSTRUCTION MANUAL**

## **MODEL BERNETTE 43/43D**

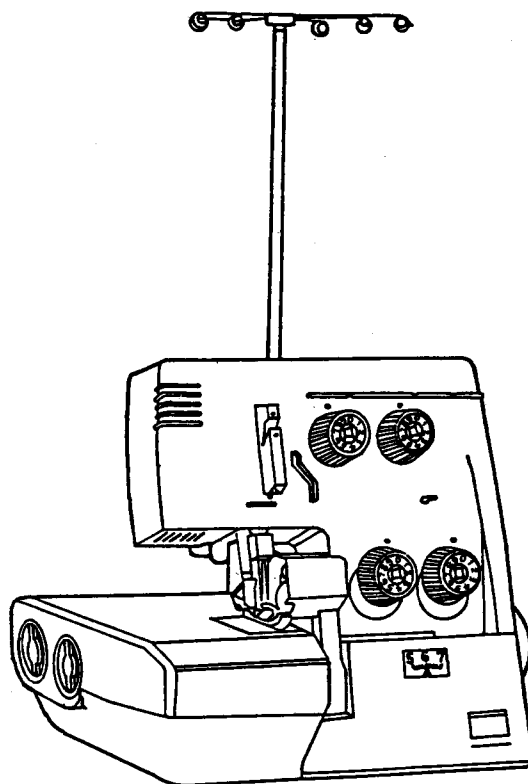

# IMPORTANT SAFETY INSTRUCTIONS

When using an electrical overlock machine, basic safety precautions should always be followed including the following.

Read all instructions before using this overlock machine.

This overlock machine is designed for household use.

## **DANGER**-TO REDUCE RISK OF ELECTRIC SHOCK

An overlock machine should never be left unattended when plugged in. Always unplug this overlock machine from the electrical outlet immediately after using and before cleaning.

**Warning**-To reduce the risk of burns, fire, electric shock or personal injury:

1. Do not allow to be used as a toy. Close attention is necessary when this overlock machine is used by or near children.
2. Use this overlock machine only for its intended use as described in this manual. Use only attachments recommended by the manufacturer as contained in this manual.
3. Never operate this overlock machine if it has a damaged cord or plug, is not working properly, has been dropped or damaged, or has been dropped into water. Return the overlock machine to the nearest authorized dealer or service center for examination, repair, electrical or mechanical adjustment.
4. Never operate the overlock machine with any air openings blocked. Keep ventilation openings of the overlock machine and foot control free from the accumulation of lint, dust, and loose fabric.
5. Never drop or insert any object into any opening.
6. Do not use outdoors.
7. Do not operate where aerosol (spray) products are being used or where oxygen is being administered.
8. To disconnect, turn all controls to the off (0) position, then remove plug from outlet.
9. Do not unplug by pulling on cord. To unplug, grasp the plug, not the cord.
10. Keep fingers away from all moving parts. Special care is required around the overlock machine needle.
11. Always use the proper needle plate. The wrong plate can cause the needle to break.
12. Do not use bent needles.
13. Do not pull or push fabric while stitching. It may deflect the needle causing it to break.
14. Unplug your overlock machine when making any adjustments in the needle area, such as threading needles, changing needles, threading loopers, changing the presser foot, changing knives, changing the needle plate, and the like.
15. Always unplug your overlock machine from the electrical outlet when removing covers, lubricating, or when making any other user servicing adjustments mentioned in the instruction manual.
16. Always unplug overlock machine before replacing the bulb. Always replace bulb with the same rated 15 watt bulb.

## SAVE THESE INSTRUCTIONS HELPFUL HINTS

1. Your lower looper has a special slot to place thread in for easy threading. This slot is pictured on the close up picture on Page 6 right below letter I.
2. To adjust stitch width, turn width dial up to increase width and down to decrease.
3. See Page 20 for instructions on how to make a narrow or rolled hem.
4. See Page 19 for instruction on how to change throat plate. When changing throat plate, **be sure to remove LEFT needle.** For instructions on removing left needle see Page 14.

# CONTENTS

Page

1. MAIN PARTS. NAMES AND FUNCTION .....	2
2. ACCESSORIES .....	3
3. SETTING UP YOUR MACHINE .....	4
4. PREPARATION FOR THREADING .....	5
5. THREADING YOUR MACHINE.....	6
6. TRIAL SEWING .....	8
7. ADJUSTING THREAD TENSIONS .....	9
8. CHART FOR TENSION ADJUSTMENT.....	11
9. ADJUSTING OVERLOCK STITCH WIDTH.....	12
10. ADJUSTING STITCH LENGTH .....	13
11. REPLACING THE NEEDLES.....	14
12. REPLACING THE CUTTING BLADE.....	15
13. CLEANING AND OILING .....	16
14. SEWING APPLICATIONS.....	17
15. SEWING APPLICATIONS.....	18
16. CHANGING THE THROAT PLATE (FOR ROLLED OR NARROW HEM) .....	19
17. HOW TO MAKE NARROW OR ROLLED EDGE.....	20
18. DIFFERENTIAL FEED (DF-TYPE ONLY).....	21
19. GATHERING/STRETCHING/PINTUCKING/SEWING IN TAPE.....	22
20. BLIND HEMMING.....	23
21. PROBLEMS AND CAUSES.....	24

# INTRODUCTION

## • THANK YOU FOR CHOOSING OUR OVERLOCKING MACHINE

This overlocking machine can stitch dependable seams on all kinds of fabric, both light and heavy, including cotton, wool, rayon, tricot, jersey, and knits.

You do not need a special table for this portable machine. It will do professional work on blouses, skirts, shirts, slacks, coats and trimming handkerchiefs, towels, tableclothes, and so on.

We suggest that you read this instruction manual carefully before you start to operate the machine.

## • FOR YOUR SAFETY.....

1. Keep your eyes on the needles when operating the overlock machine. Do not touch the hand wheel, the knife or the needles when the machine is running.
2. Make sure to turn the power switch to "off" and pull out the plug from electric socket in the following cases:
  - \* When you have finished your sewing.
  - \* When you temporarily leave the overlock machine.
  - \* When replacing any parts.
  - \* When cleaning or adjusting the machine.

## • BEFORE YOU USE.....

1. Wipe dust and oil off the overlock machine to avoid any stains on the sewing materials.
2. Do trial sewing by using the same sewing materials you intend to sew.
3. Read this instruction manual thoroughly before replacing the knives and the needles. Follow the instructions for correct replacements and adjustments.
4. This machine has a maximum speed of 1,400 s.p.m. The motor and handwheel turn the same direction as a household sewing machine (toward the sewer).

## • SPECIFICATION

Description	Specification
Number of threads	4 or 3
Number of needles	2 or 1
Sewing speed	Up to 1400 s.p.m
Stitch width	4 thread—6mm
	3 thread—4mm
Stitch length	1~4.5mm
Differential feed ratio	0.8~2 (DF-type only)
Lift of presser foot	4.5mm
Needle	HAX1 No. 11~14 or
	130/705H No. 75~90
Dimensions	290(W)×260(L)×275(H)
Weight	6kg (13 lbs)
	6.6kg (15 lbs) (DF-type)

# MAIN PARTS: NAMES AND FUNCTIONS

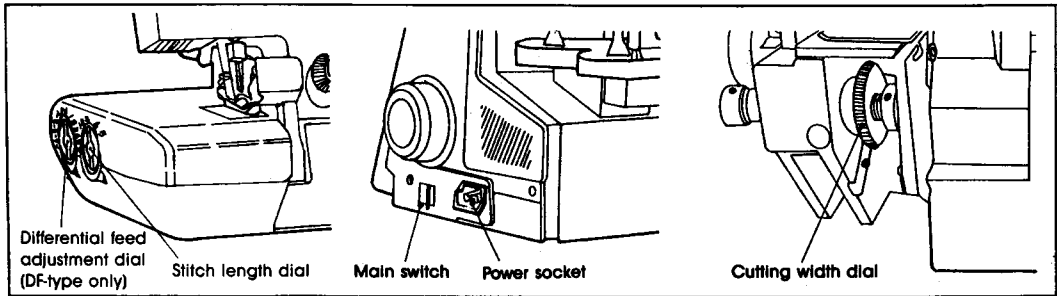
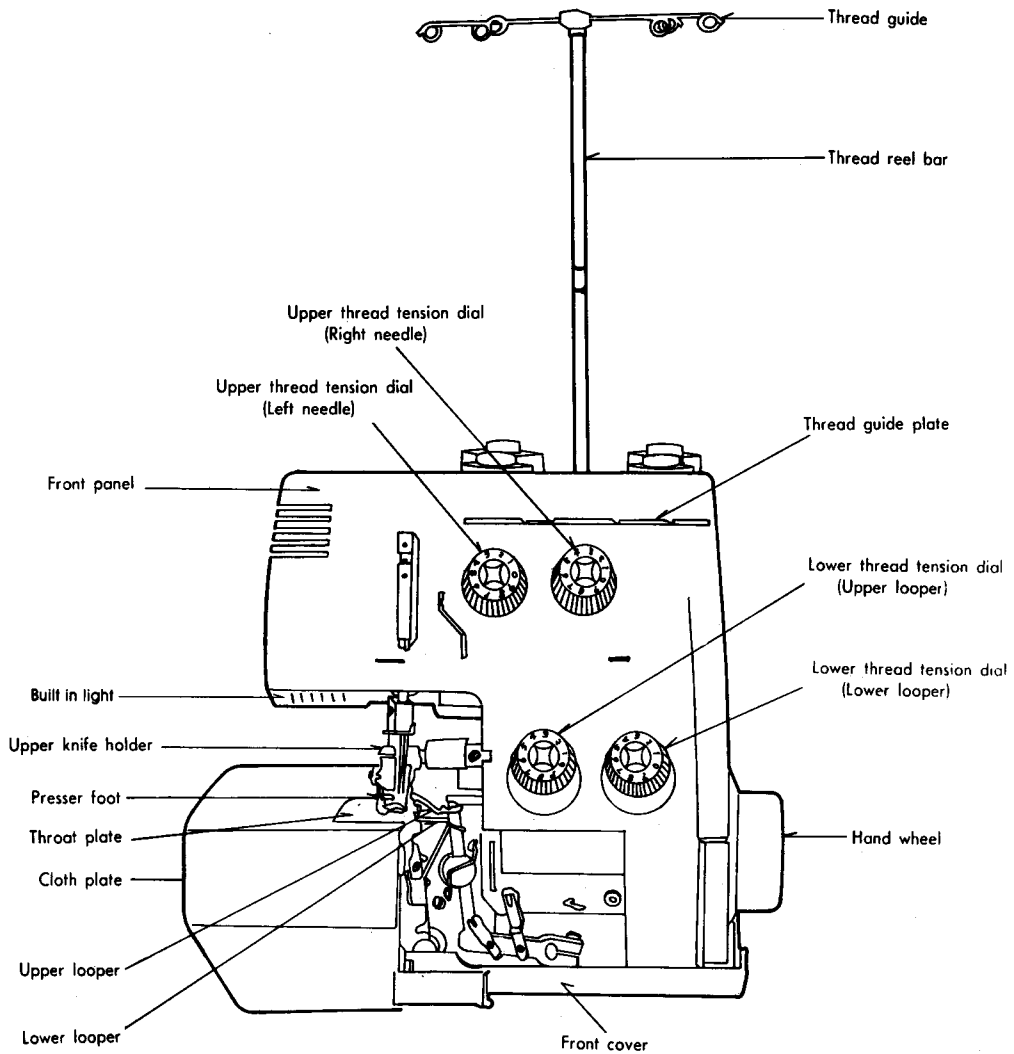

# ACCESSORIES

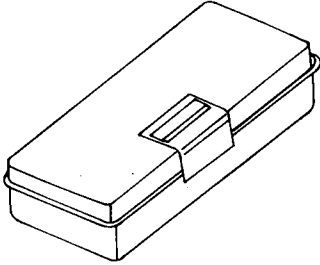

Accessory box

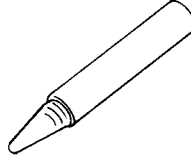

Oiler

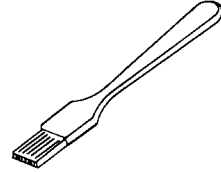

Brush

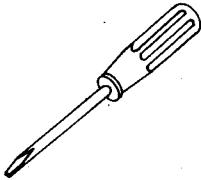

Screwdriver



Tweezers

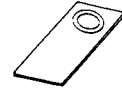

Needles (3pcs)  
(HAx1 #14)

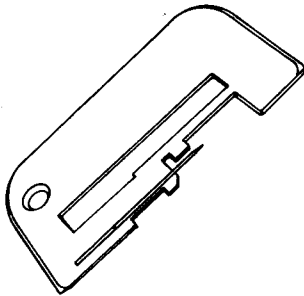

Roll edge Throat plate

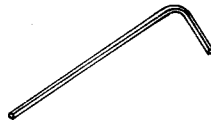

Hexagon wrench

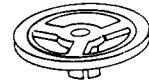

Thread spool holder caps  
(4pcs)

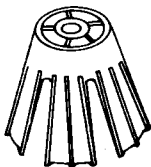

Cone holder (4 pcs)

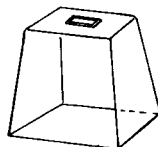

Machine cover

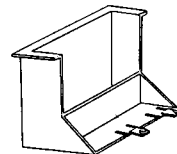

Waste collector

## SETTING UP YOUR MACHINE

### • Connecting the foot control

Connect the foot control plug to the machine socket as shown below, and then connect the main plug to the main socket.

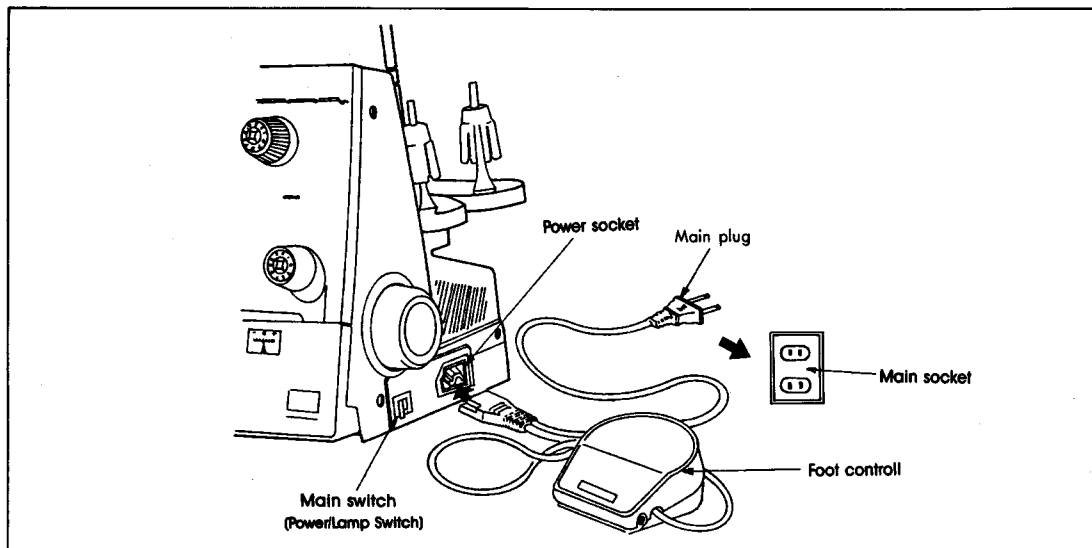

### • Foot control

Place your foot on the foot control as shown.

As you lightly press on the foot control, the machine will sew slowly and increase in speed with added pressure.

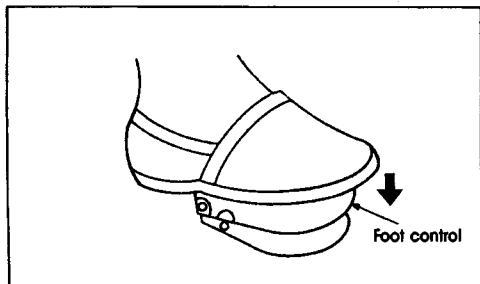

### • Power/lamp switch

The power switch is located on the lower right side of the machine.

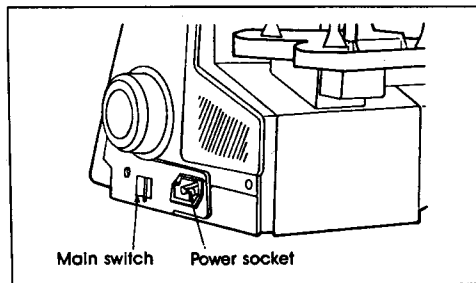

### Caution:

1. Disconnect the electrical cord from the wall outlet when machine is not in use or when it is being cleaned.
2. Turn the power switch to the "OFF" position before connecting the cord and before changing needles or throat plates. This will help prevent accidents.

# PREPARATION FOR THREADING

## • Thread reel bar

Pull up thread reel bar to its highest point before threading.

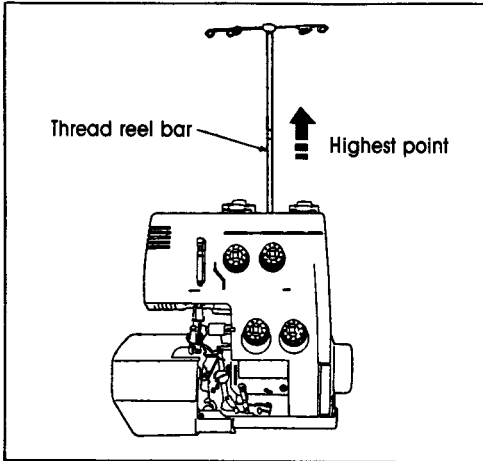

## • Overlock thread

It is advisable to use a good quality overlock thread when sewing with this overlock machine.

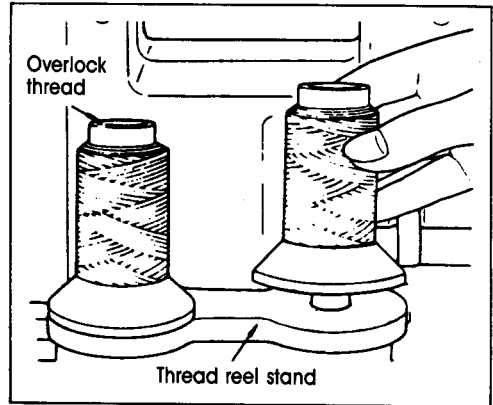

## • For domestic spools

Domestic type thread spools can be used on this machine.

- ① Place the domestic spool on the thread reel stand.  
(The thread notch on the spool should be at the bottom.)
- ② Push the spool holder cap provided, on the spool.

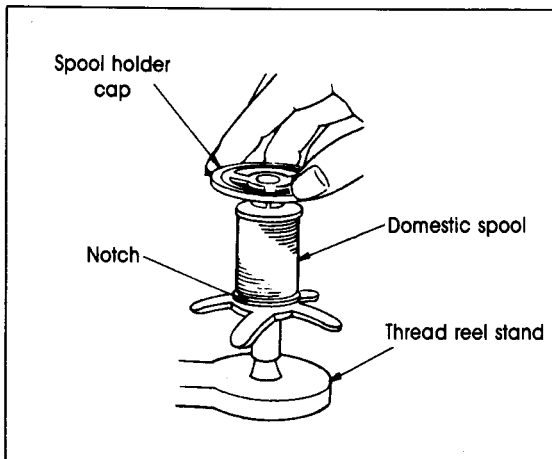

## HOW TO ATTACH THE WASTE CHIP BOX

To catch the cut-off fabric as you sew and for keeping your working area clean, place the waste collector box between the machine and table.

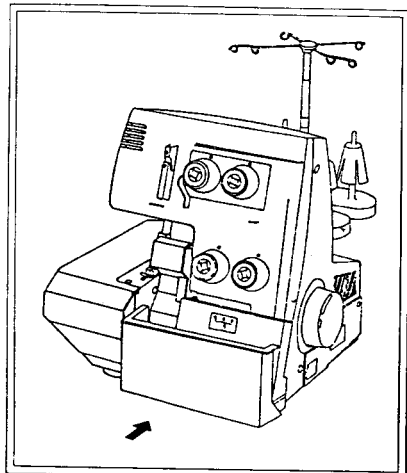



# THREADING YOUR MACHINE

Correct threading is important otherwise uneven stitches or thread breakage may result. You will find a threading illustration when you open the front cover. In addition, each thread guide is colored for threading indication. To help in threading, threader and tweezers will be found in the accessory bag.

- ① Open front cover and cloth plate.
- ② Raise the needle to its highest point by turning the hand wheel toward you by hand.
- ③ Pass the lower looper thread and upper looper thread as illustrated. Make certain to pass the thread between the two tension discs.
- ④ Pull the thread end about 10cm (4inches) long from the looper eyes, place the threads together under the presser foot.

Helpful hints:

- a. Thread looper before threading needles
- b. When threading left looper, it may be more convenient to have your tension set on "0". This will allow you to have enough slack in the thread. After the machine is threaded increase the tension to the appropriate number.

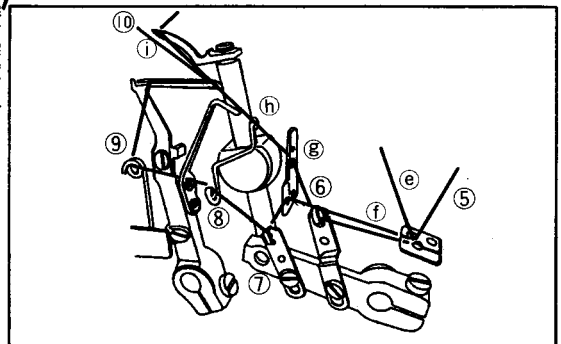
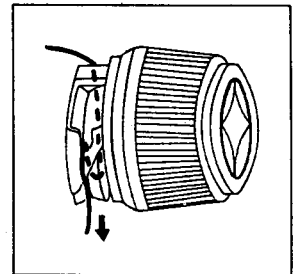
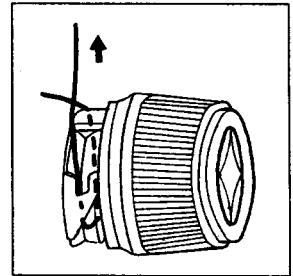
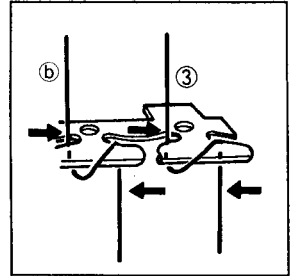
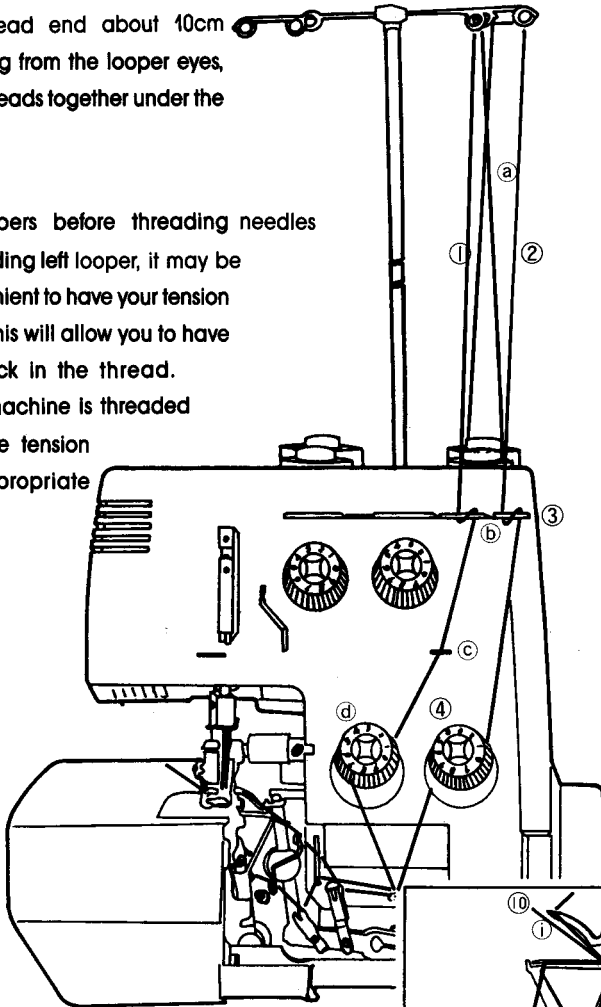

## Warning:

Switch the overlock machine off ("0") when making any adjustment in the needle area, such as threading needles, changing needles, threading loopers, changing the presser foot, knives or the needle plate, and the like.

⑤ Pass the right and left needle threads as illustrated below. Make certain to pass the thread between the two tension discs.

⑥ Pull the thread end about 10cm (4 inches) beyond the needle eyes.

⑦ Place the needle threads together under the presser foot.

⑧ Close front cover and cloth plate when the threading is finished.

NOTE: To assist thread passing around tension dials, turn all four dials to the "O" setting and make sure the thread passes through the tension discs and behind the hook in each case. Then turn each knob to the desired setting numbers according to the fabrics (See Page 11).

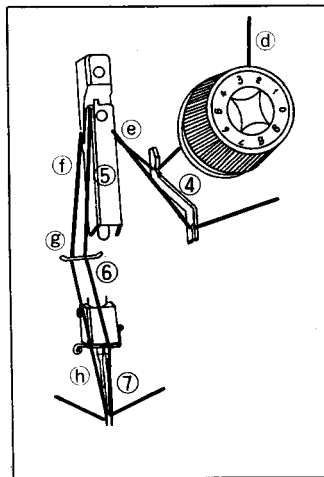
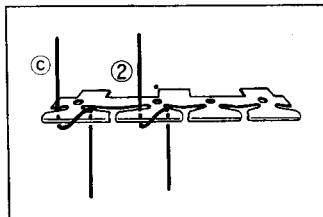
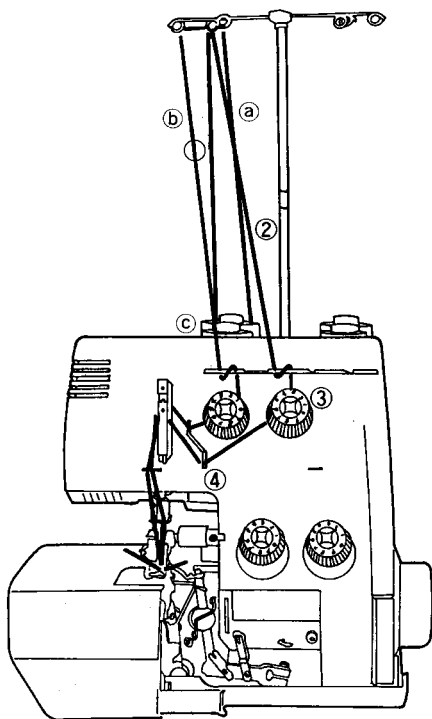

## EASY THREAD CHANGING

Instructions for changing threads are given below.

1. Cut the threads near the spools.
2. Exchange the spools with new ones and tie the ends to the remaining threads, making the knots as small as possible.
3. Turn the Thread Tension Dials to the smallest number.
4. Press the Foot Control and run the machine until the upper and lower thread knots come through the looper holes.
5. Stop the needle thread knots before they pass through the eye of the needles. Cut the threads and, manually, pass them through the needle eyes.

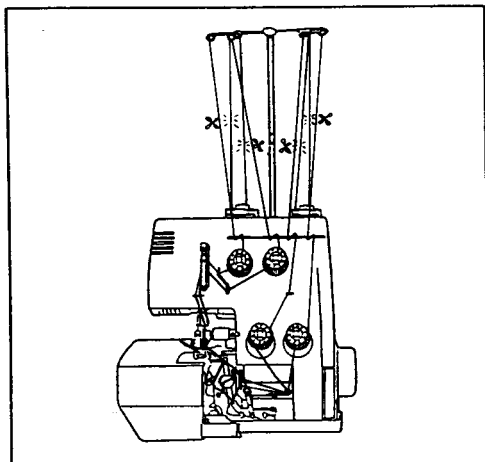

# TRIAL SEWING

When the overlock has been threaded for the first time or re-threaded because of thread breakage during sewing, start sewing in the following manner.

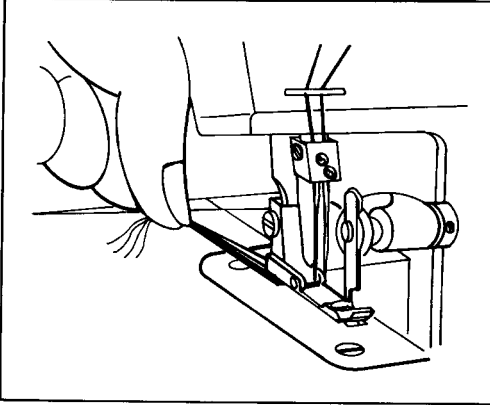

① Place the needle threads and looper threads under the presser foot.

② While holding the end of threads between your left finger tips, gently turn the hand wheel toward you two or three times with your right hand to check that the threads form the overlock stitch.

③ Then place fabric for trial sewing under the presser foot and start sewing.

④ When work is finished, continue running the machine and move work back slowly so that a chain of thread 5~6cm long is made as shown at left. Cut the threads with scissors.

⑤ Leave this chain ready to start next sewing.

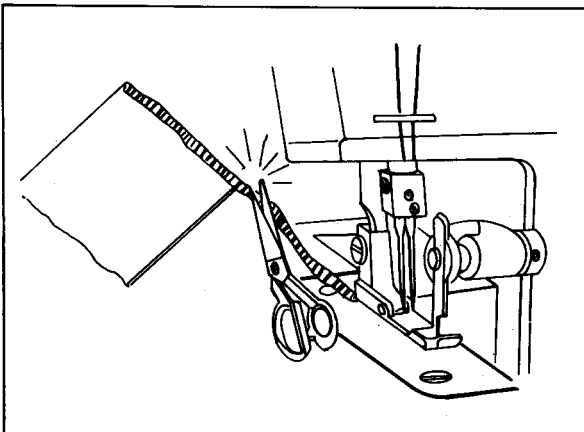
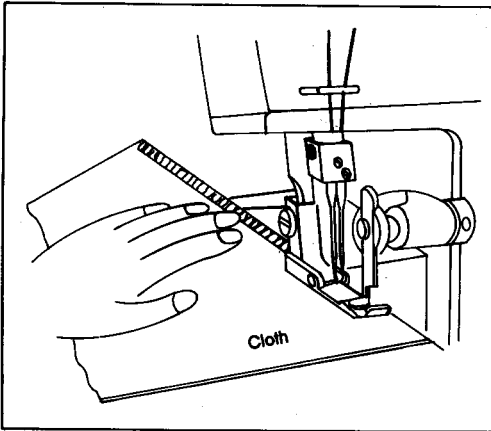

# ADJUSTING THREAD TENSIONS

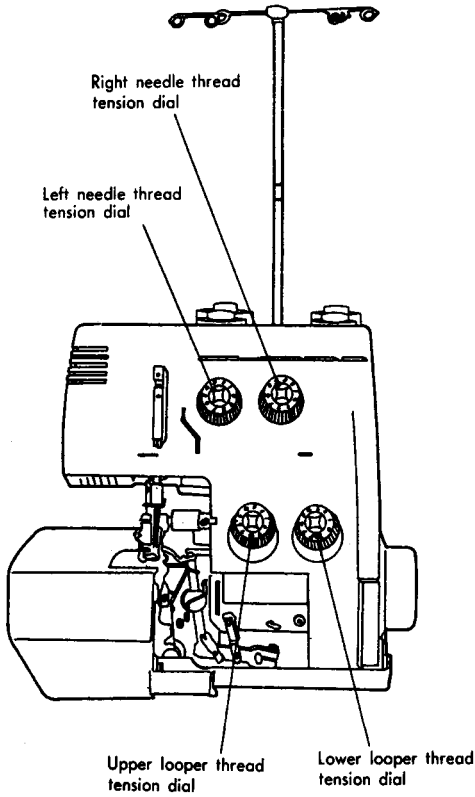

Thread tension differs with the type of fabric and the thickness and type of thread. Adjustment of thread tensions should be made each time you sew. Adjust the tension dials using the upper and lower thread tensions while watching the stitch as illustrated. Thread tension is tightened by turning the applicable tension dial clockwise, and loosened by turning counter clockwise.

## • Proper thread tension

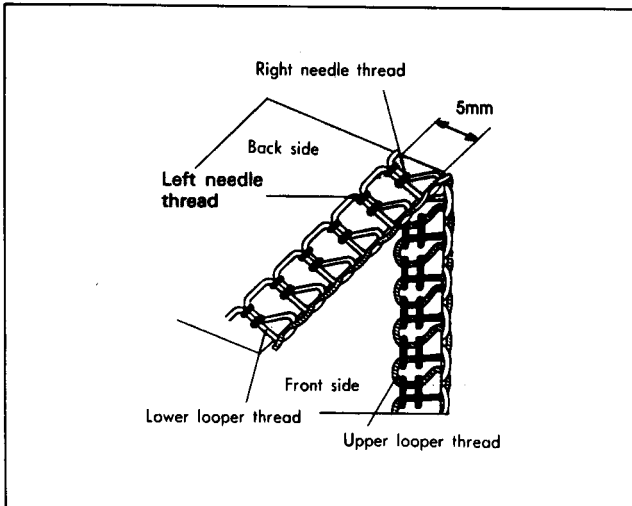

## ADJUSTING THREAD TENSIONS (CONTINUED)

(A) Lower looper thread tension is too tight or upper looper thread is too loose.

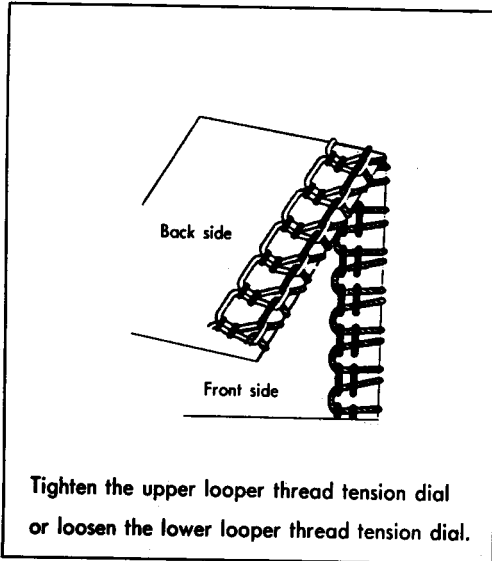

(B) Upper looper thread tension is too tight or lower looper thread is too loose.

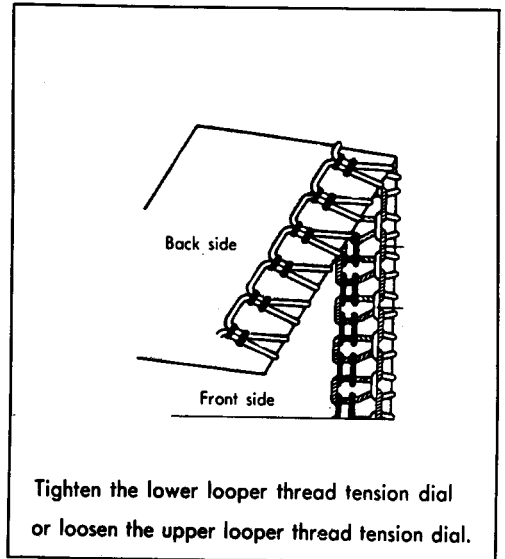

(C) Left needle thread tension is too loose, upper and lower looper tensions are too tight or cutting edge too wide.

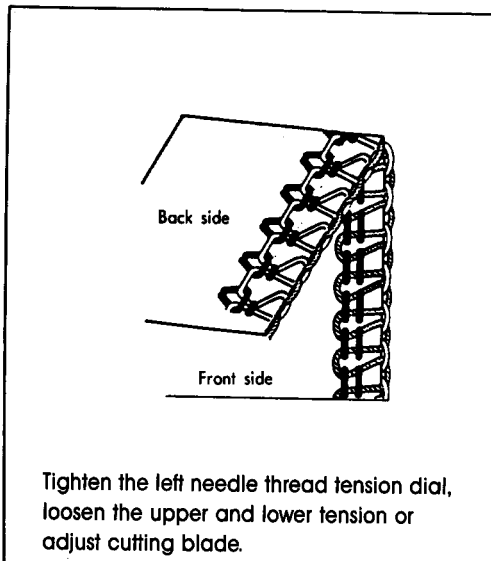

(D) Right needle thread tension is too loose.

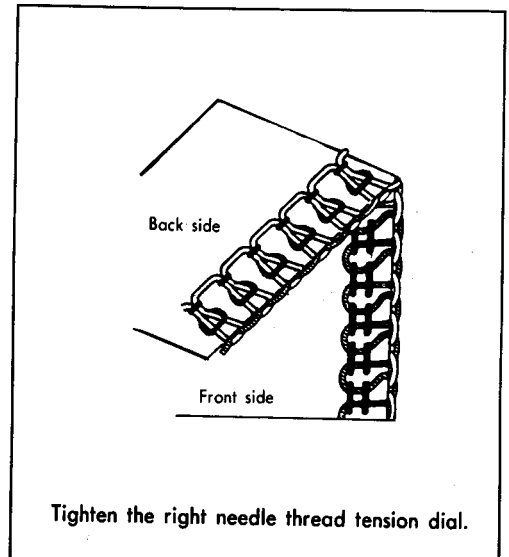

# CHART FOR TENSION ADJUSTMENT

Fabrics	Threads	Needle	Stitch length	Recommended tension settings
<b>Light-weight</b> <ul style="list-style-type: none"> <li>• Georgette</li> <li>• Organdy</li> <li>• Lawn</li> <li>• Voile</li> <li>• Crepe de chine</li> <li>• Silk</li> </ul>	<ul style="list-style-type: none"> <li>• Cotton</li> <li>• Spun polyester</li> <li>• Polyester</li> </ul>	Standard sewing machine needle Type: HA×1 (Japan) or 130/705H (Europe) or 15×1 (USA)	2.0~3.5m/m  Standard 2.5m/m	
<b>Medium weight</b> <ul style="list-style-type: none"> <li>• Cotton</li> <li>• Poplin</li> <li>• Wool</li> <li>• Linen</li> <li>• Gingham</li> <li>• Corduroy</li> <li>• Suede</li> <li>• Safin</li> <li>• Fleece</li> </ul>	<ul style="list-style-type: none"> <li>• Cotton</li> <li>• Spun polyester</li> <li>• Polyester</li> </ul>		2.0~3.5m/m  Standard 2.5m/m	
<b>Heavy weight</b> <ul style="list-style-type: none"> <li>• Denim</li> <li>• Tweed</li> <li>• Velour</li> <li>• Canvas</li> <li>• Upholstery</li> </ul>	<ul style="list-style-type: none"> <li>• Cotton</li> <li>• Spun polyester</li> <li>• Polyester</li> </ul>		2.5~4.0m/m  Standard 3.0m/m	

# ADJUSTING OVERLOCK STITCH WIDTH

This machine is a two needle, three or four thread convertible overlock machine. Select your stitches according to what and how you sew :

- (a) 3-thread overedge stitch, 5mm width. Use only left needle and three threads. Remove the right needle.
- (b) 3-thread overedge stitch, 3mm width. Use only the right needle and three threads. Remove the left needle.

The right or the left needle can be removed simply by loosening the needle set screw.

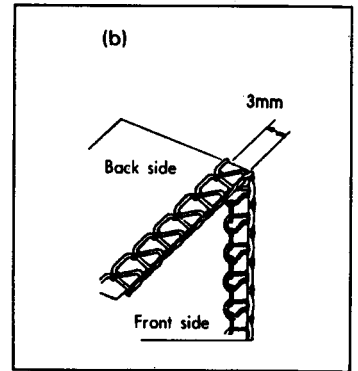
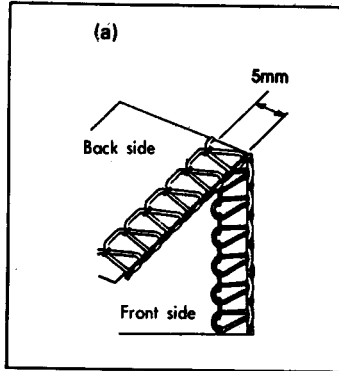
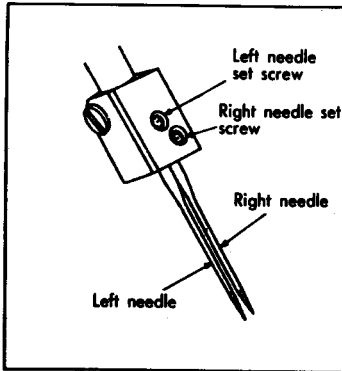

# ADJUSTING CUTTING WIDTH

The proper cutting width differs with the type of fabric. Check the seam each time, and adjust the cutting width as follows.

1. Turn power switch off.
2. Open the front cover and cloth plate.
3. Turn the stitch width dial (away or toward you) until the red stitch width indicator matches the desired width line in the front cover window.

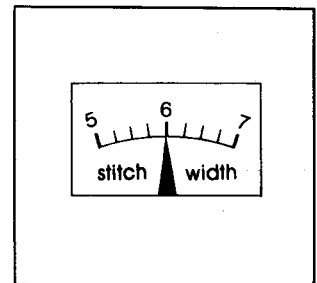
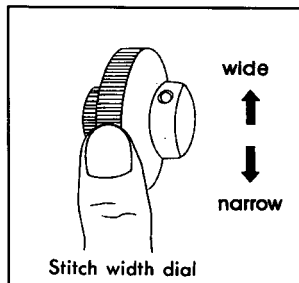
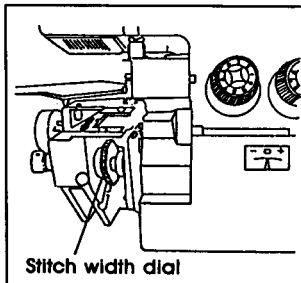

## ADJUSTING STITCH LENGTH

The maximum stitch length of this machine has been PRE-SET to 3mm.

To adjust to a shorter length, simply turn the length dial to a lower number.

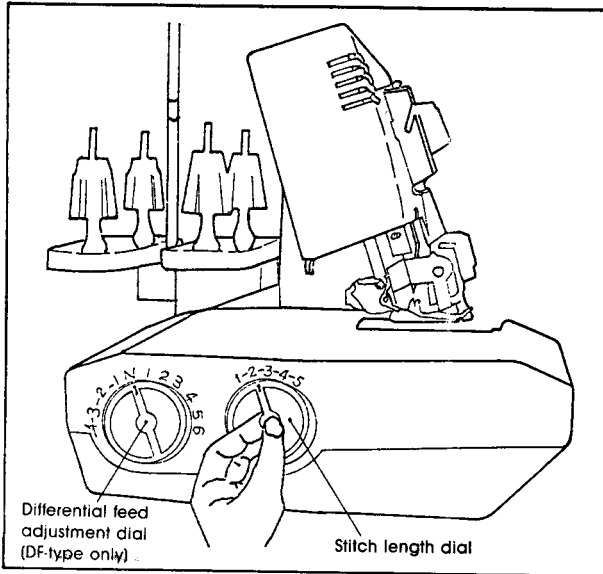

## ADJUSTING PRESSER FOOT PRESSURE

The presser foot pressure of the machine has been pre-set and requires no particular readjustment according to the type of fabric (light-or heavyweight). However, if you need to adjust the presser foot pressure, turn the presser adjusting screw with a coin or screwdriver.

For sewing very thin fabric, loosen the pressure by turning the screw counter clockwise, and for heavy fabric, tighten by turning it clockwise.

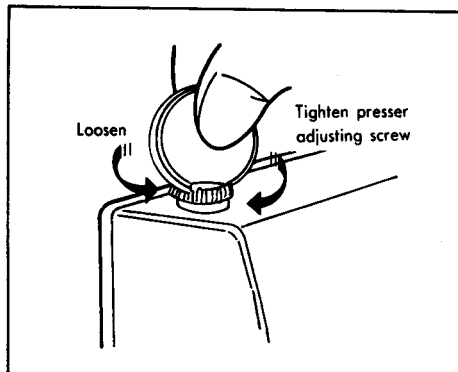



## REPLACING THE NEEDLES

- Turn the power switch to "off" before replacing a needle.
  - Your needle system is 130/705H (HAx1).
- ① Raise the needle bar to its highest position by turning the handwheel towards you.
  - ② Open the front cover and lower the presser foot.
  - ③ Using the hexagon wrench, loosen the needle clamp screws and remove the needles.
  - ④ Insert the needle as far as it will go into the needle clamp, flat side of needle facing away from you. Tighten needle clamp screw with wrench.
  - ⑤ Make one complete turn of hand wheel to check for proper clearance.

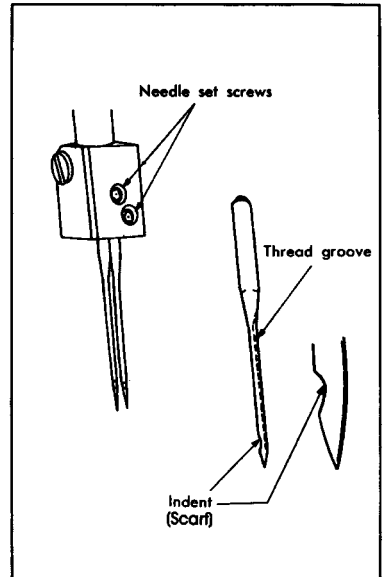
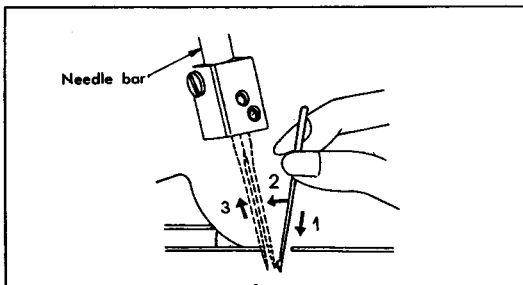

- Be sure to use proper size needle for the thread and type of material you are sewing. Using a bent or blunt needle may result in breaking thread or poor stitching.

## REPLACING THE LIGHT BULB

\* CAUTION: Always disconnect your machine from the power supply before replacing the light bulb.

Do not attempt to change the bulb until it is cool.

Do not replace with a bulb of more than 15 watts.

- ① Loosen the light cover screw.
- ② Pull out the light cover and remove the old bulb by unscrewing. Replace with a new bulb.
- ③ Reset the light cover screw.

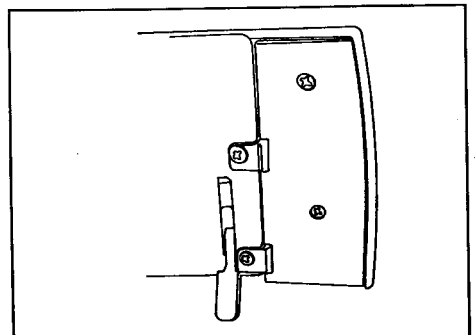
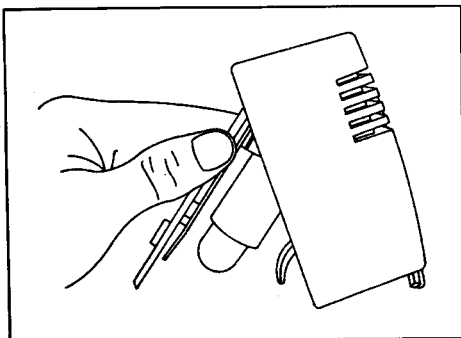

# REPLACING THE CUTTING BLADE

**CAUTION:** Be sure to disconnect the power supply by removing plug from socket-outlet before replacing the cutting blade.

The upper blade might become dull after using over a period of time and will need to be replaced. A spare upper blade is provided in your accessory case.

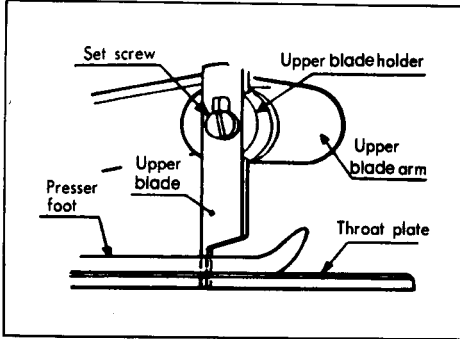

- ① Raise the upper blade arm to its highest position by turning the hand wheel toward you.
- ② Loosen the upper blade set screw and take off the upper blade.
- ③ Replace the new upper blade and tighten the upper blade set screw.
- ④ Turn the hand wheel toward you to set the cutting edge of the upper blade to its lowest position with the lower blade to overlap between 0.5mm and 1mm. Tighten the upper blade set screw securely.

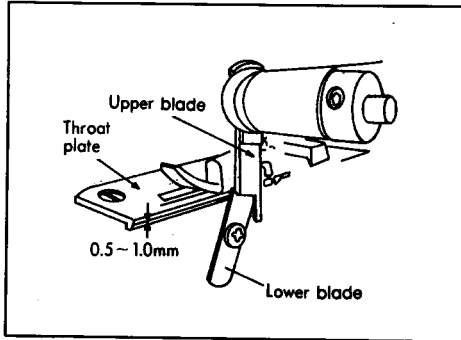

## • Replacing the lower blade

The lower blade (Fixed knife) of machine is made of a special material which does not require frequent replacement. However, should it chip and need to be replaced, a new one can be purchased from your local dealer.

# BUILT-IN POCKET TYPE HANDLE

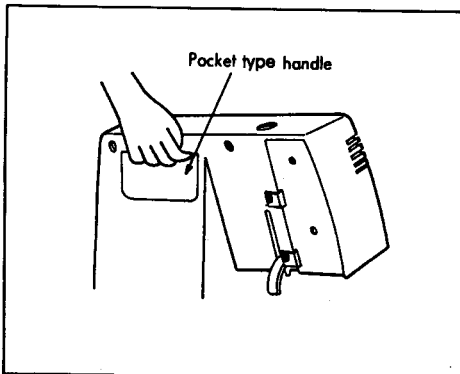

The built-in pocket type handle is a convenient way to carry your machine.

# CLEANING AND OILING

To keep your machine running smoothly, it is necessary to keep it clean and lubricated at all times.

First, disconnect machine from power supply by removing plug from socket-outlet.

Open both front and side covers. Using the brush provided, remove dust and lint that has accumulated in the whole exposed area. Then apply a few drops of oil to the points indicated by the arrows below.

Always use a good quality sewing machine oil (we suggest Mobil Velocite #10 or equivalent).

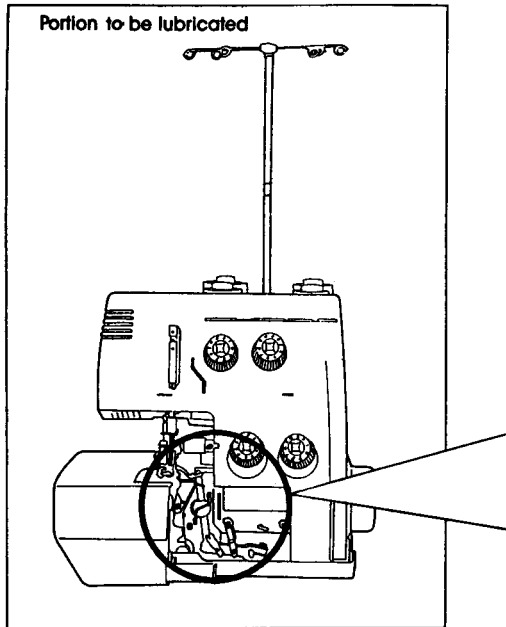

- Apply one or two drops of oil to each lubrication point.

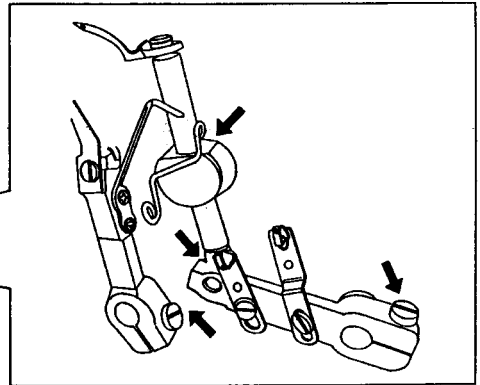

- Apply one or two drops of oil to each lubrication point.

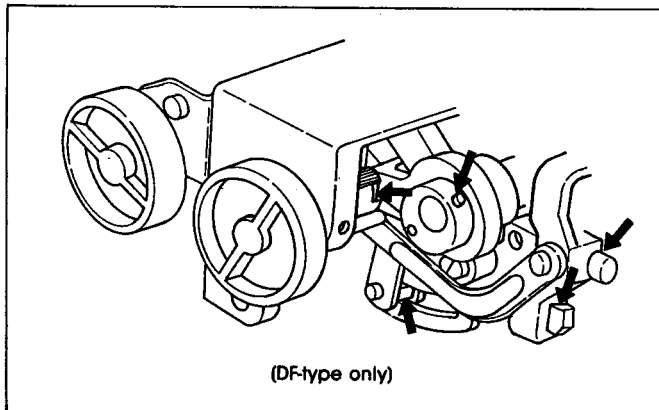

# SEWING APPLICATIONS

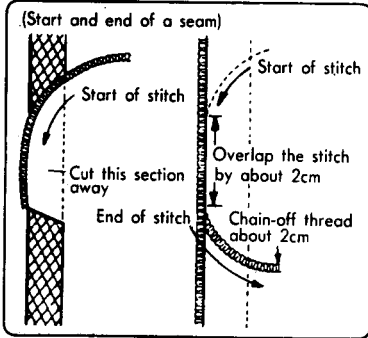

## •Overcasting the hem of a skirt

Overcast the hem edge, keeping the depth of the hem even. When overcasting the hem on a garment which is shaped, it is necessary to first work a line of straight stitches with a normal sewing machine to ease in the fullness evenly around the hem.

To overcast, place the fabric at an angle under the presser foot and sew into the hem edge position in a curved line. At the end of the sewing, overlap the beginning stitches by approx. 2cm and stitch off the fabric to leave a chain of threads about 2cm. This chain-off thread at the end of the sewing prevents the stitch from coming undone. Slip these ends into the hem when sewing the hem into position.

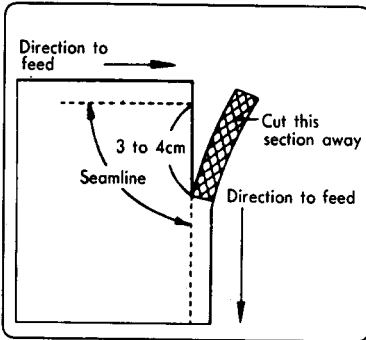

## •Overcasting a corner

Because there is a certain distance between the knife and the needle, you should cut away a small piece of the seam allowance at the beginning (as illustrated) so that the fabric can reach the needle.

- ① When you have finished sewing along one edge, lift the presser foot and pull the work out the back of the foot, taking care not to break the threads.
- ② Turn the work, lower the presser foot and sew evenly along the next edge.

## •Making a stitched and overcast seam

Since your machine has a knife to cut the edge of the fabric, you cannot sew with pins inserted as you can do with a normal domestic zigzag machine. The best way is to baste the seam before you sew. Alternatively, you can save time by inserting the pins parallel with the edge and then stitch two or more pieces of fabric together without having to remove the pins.

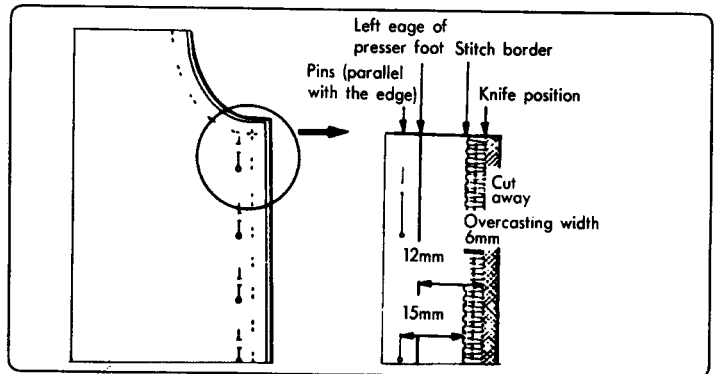
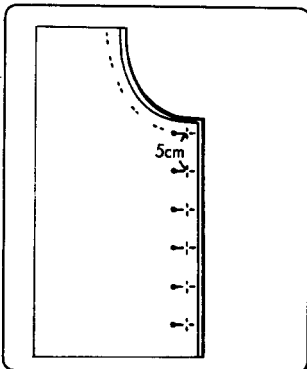

- ① Insert the pins at equal distances of about 5cm according to the fabric.

- ② Insert the pins approx. 1.5–2.0cm apart, parallel to the raw edge taking into account the width of the presser foot.

# SEWING APPLICATIONS

## • Application

This machine is suitable for sewing the following :

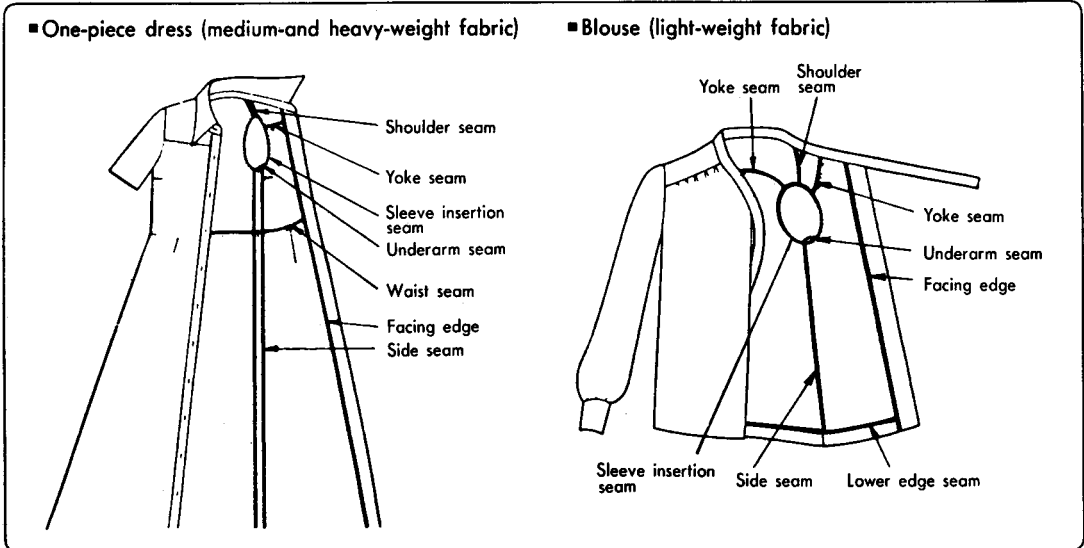

## • How to change presser foot

1. Removing presser foot – raise the foot, pull the one-touch lever toward you, and the foot will drop off.
2. Putting on presser foot – center the desired presser foot under shank. Lower the presser bar until the groove on the shank connects with the small pin on the foot.
3. Gently push the one-touch lever toward the needle to release the lever.

## • How to remove shank

1. Keep the presser bar up, loosen the shank set screw and the shank will drop off.
2. When you replace the shank, tighten the set screw firmly with a screw driver.

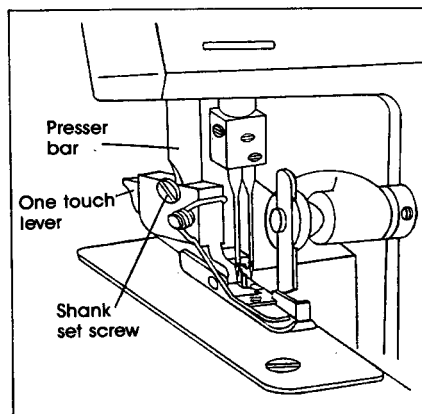

## CHANGING THE THROAT PLATE (FOR ROLLED OR NARROW HEM)

The machine comes with a standard overedge needle throat plate attached to the machine.

To change the throat plate when sewing rolled overedges (rolled hems):

- ① Lift and release the presser foot.
- ② Open the front cover. Loosen the throat plate screw and remove the standard throat plate, replacing with the rolled edge throat plate. Tighten the screw.
- ③ Loosen the left needle set screw and remove the left needle.
- ④ Open the left cover. Turn the cutting width adjustment dial to move the lower knife to the left edge.
- ⑤ Close the front cover. Replace presser foot.
- ⑥ Turn the handwheel toward you and set needle to its lowest position.
- ⑦ Lower the presser foot and make sure there is no extra space between the bottom of the presser foot and the throat plate.

\* Delicate adjustments may be necessary in accordance with the type of material being used. Make a trial sewing sample and check if any adjustments are needed. Also, better results are possible by adjusting the position of the lower knife.

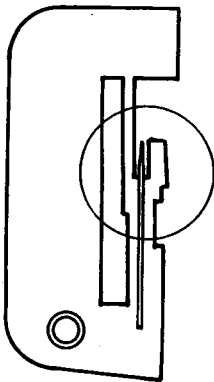

Standard overedge  
throat plate

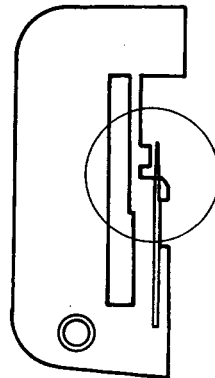

Rolled hem  
throat plate

# HOW TO MAKE A NARROW OR ROLLED EDGE

Please make sure power is off when replacing the parts and making adjustments.

- To adjust tension for rolled or narrow edges, refer to the table below for suggested combinations of material and thread. Proper thread tension differs with the type of fabric and the thickness and type of thread.

Adjustment of thread tension should be made each time you sew.

Important: 1. See page 19 for changing the throat plate

2. Remove left needle (page 14)

3. The stitch length for rolled hems should be set between 1. and 2.

Fabrics	Tension dial to be adjusted	Threads	
		Rolled hemming	Narrow hemming
<ul style="list-style-type: none"> <li>• Georgette</li> <li>• Lawn</li> </ul>	Needle Thread	<ul style="list-style-type: none"> <li>• Spun Polyester No. 50 ~ 80</li> <li>• Continuous Polyester No. 50 ~ 80</li> </ul>	<ul style="list-style-type: none"> <li>• Spun Polyester No. 50 ~ 80</li> <li>• Continuous Polyester No. 50 ~ 80</li> </ul>
<ul style="list-style-type: none"> <li>• Crepe-de-chine</li> <li>• Broad cloth</li> <li>• Rayon</li> </ul>	Upper Looper Thread	<ul style="list-style-type: none"> <li>• Wooly Nylon</li> </ul>	<ul style="list-style-type: none"> <li>• Wooly Nylon</li> <li>• Spun Polyester No. 50 ~ 80</li> <li>• Continuous Polyester No. 50 ~ 80</li> </ul>
<ul style="list-style-type: none"> <li>• Voile</li> <li>etc.</li> </ul>	Lower Looper Thread	<ul style="list-style-type: none"> <li>• Spun Polyester No. 50 ~ 80</li> <li>• Continuous Polyester No. 50 ~ 80</li> </ul>	<ul style="list-style-type: none"> <li>• Spun Polyester No. 50 ~ 80</li> <li>• Continuous Polyester No. 50 ~ 80</li> </ul>

## Rolled edge tension settings

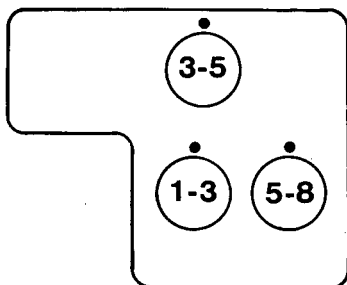

## Narrow edge tension settings

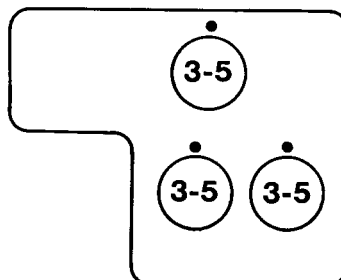

### Rolled hemming

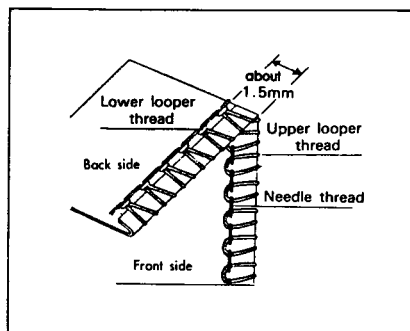

### Narrow hemming

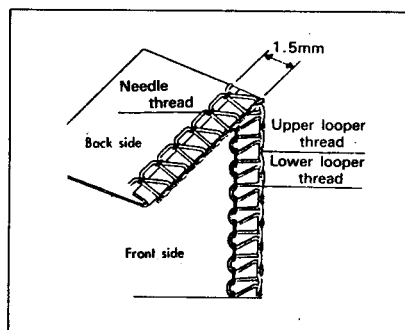

# DIFFERENTIAL FEED (DF-type only)

Differential feed prevents waving seams in knitted fabrics. It also helps control the movement between layers of fabric, and ensures pucker-free seams in smooth synthetic fabrics.

## Differential feed mechanism

There are two feed dogs, one front and one rear. The two feed dogs move independently and the distance each feed dog travels during one complete movement can be varied.

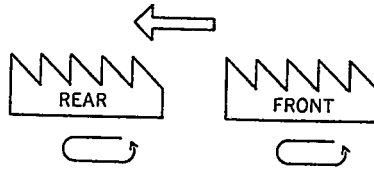

Differential feed ratio 1 vs. 0.8~2

## Adjusting the differential feed

The differential feed can be adjusted by simply turning the differential feed adjustment dial in the direction desired. Please note that the Stretch 4-step and the Gathering 6-step adjustments to the differential feed can be made while sewing.

Important:

When sewing without differential feed, the adjustment dial for the differential feed should be set on the "N" position.

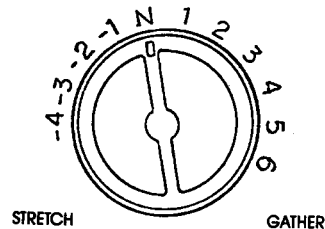
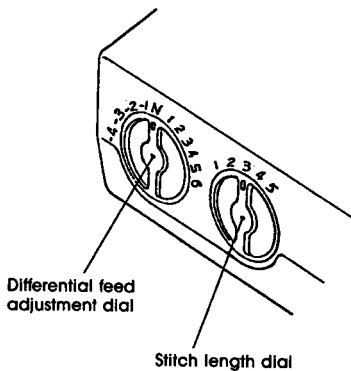



### Gathering:

For perfectly flat seams in knits, the distance traveled by the front feed dog should be greater than that of the rear feed dog. The front feed dog, therefore, feeds an amount of fabric in excess of that fed by the rear feed dog, flattening the seam without the slightest hint of movement between the two layers of fabric.

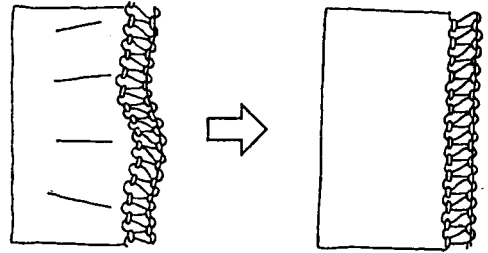

### Stretching:

To avoid any puckering in seams on closely woven fabrics or smooth nylon, the distance traveled by the rear feed dog must be greater than that of the front feed dog. The front feed dog, therefore, holds the fabric back so that the rear feed dog can take it up behind the needle without any puckering or movement between the two layers of fabric.

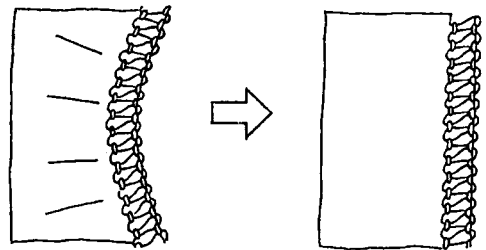

### Pintucking:

Pin tucking is an attractive decorative stitch for blouses and children's wear.

1. Fold fabric with wrong sides together.
2. Adjust the plastic guide so that the stitches just overcast the folded edge.
3. Lower the presser foot and sew.
4. Sew as many rows as desired and press them to lay flat on one side.

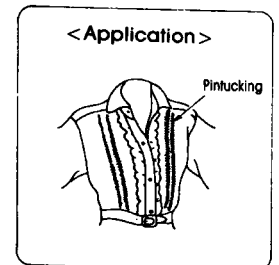
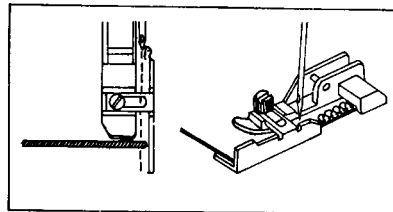

### Sewing in tape

The standard presser foot is equipped with a tape guide. The tape can be sewn in at the same time as regular sewing to strengthen shoulder or side seams in garments made from knits or stretch fabrics.

(USE 4 ~ .5 mm WIDTH OF THE TAPE)

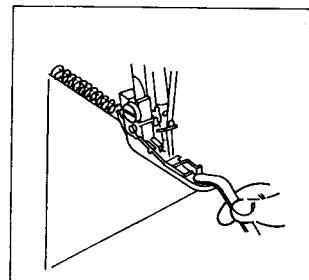
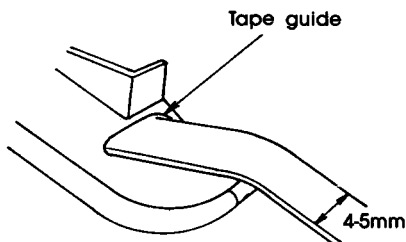

# BLIND HEMMING

By changing the presser foot to the "Blind Hem Presser Foot", you can sew blind stitches while trimming fabric and produce a durable hem which is almost invisible on the right side of the article sewn. It is useful for sewing cuffs, trouser bottoms and pockets, etc.

## Sewing

First sew a test sample on a scrap of fabric and adjust the seam guide and thread tension.

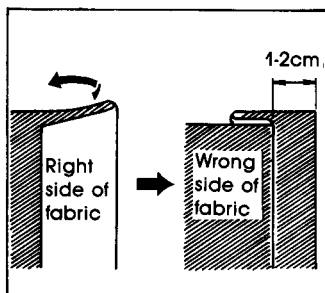

1. Fold hem up as desired, fording it back toward the right side of the fabric. Leave a 1 to 2 cm seam allowance to the right.

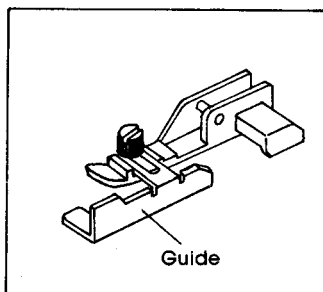

2. The plastic guide on the presser foot ensures even feeding of the fabric while blind hemming. This guide is adjusted by turning the screw.

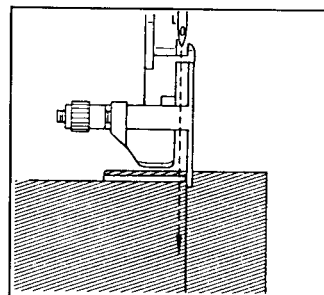

3. Raise the presser foot.
4. With the wrong side up, place the fabric under the presser foot so that the plastic guide is just touching the folded edge.
5. Adjust the guide so that the needle just pierces the folded edge.

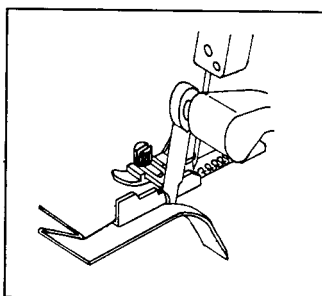

6. Lower the presser foot and sew hem, guiding fabric evenly along the plastic guide.

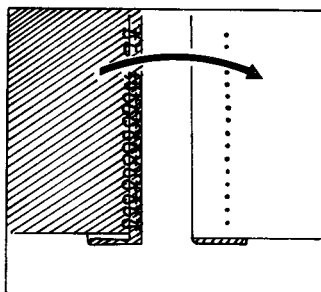

7. When hem is completed, open the fabric and press hem.

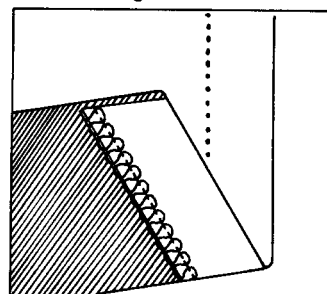

**CORRECT THREAD TENSION**  
The upper and lower looper threads are crossed on the cut edge of fabric.

## PROBLEMS AND CAUSES

• Before calling for service, check the information below.

Problem	Cause	Corrective action	Page
Fabric does not feed.	① The presser foot pressure is too light.	Turn the presser foot pressure adjusting screw clockwise to increase the presser foot pressure.	12
Needle breakage.	① The needle is bent or the needle point is blunt.	Replace with a new needle.	14
	② The needle has been improperly attached to the needle bar.	Attach the needle correctly to the needle bar.	14
	③ You have forcibly pulled the fabric.	Lightly guide on the edges of the fabric while you are sewing.	
Thread breakage.	① Threading is wrong.	Thread the machine correctly.	6~7
	② Thread tension is too tight.	Decrease the thread tension.	9~11
	③ The needle has been improperly attached to the needle bar.	Attach the needle correctly to the needle bar.	14
	④ Wrong needle is used.	Use correct needle.	14
Skipping stitches.	① The needle is bent or the needle point is blunt.	Replace with a new needle.	14
	② The needle has been improperly attached to the needle bar.	Attach the needle correctly to the needle bar.	14
	③ The machine has been improperly threaded.	Thread the machine correctly.	6~7
	④ A wrong needle is used.	Use the correct needle.	14
Stitches are irregular.	① Thread tension is not correct.	Adjust thread tension.	9~11
	② Cutting space is too narrow	Readjust the cutting space width	13
Fabric is puckering.	① The needle thread tension is too tight.	Reduce the needle thread tension.	9~11
	② The machine has been improperly threaded or a thread has been caught at some unnecessary point.	Re-thread the machine correctly.	6~7
Motor problems.	① Excessive noise. ② The motor will not run. ③ Sparks are produced.	Consult your dealer	

If above corrective actions do not solve your trouble, contact your dealer.