

SERVO-TOP

QE5542

CE

Type

P40SE 02

Instruction Manual

Part 2

QUICK-ROTAN Elektromotoren GmbH
Königstraße 154
67655 Kaiserslautern
Tel: 06 31/2 00 38 80
Fax: 06 31/2 00 38 62

Form-Nr. 273.273 / 2
English 1997-05-20

Contents

Page

Part 2

7.	Construction and description of the SERVO-TOP drive system	7.1 - 7.5
7.1	Motor QE 5542	
7.2	Control system - control box	
7.3	Speed control unit (command unit)	
7.4	Synchronizer (position control unit)	
7.5	ON/OFF switch (power connection unit)	
7.6	External operator panel OC-TOP	
8.	Application	8.1 - 8.6
8.1	Sewing without an external operator's control panel	
8.2	Sewing with the external operator's control panel B2	
8.3	Sewing with external operator's control panel OC-TOP	
8.3.1	Sewing without sewing program (manual sewing)	
8.3.2	Sewing with sewing program - programmed sewing, general	
8.3.3	Backtack/darning programs	
8.4	Error messages (malfunction diagnostics)	
9.	Programming by the user	9.1 - 9.15
9.1	User programming with operator panel OC-TOP	
9.1.1	Direct programming	
9.1.2	Parameter programming	
9.1.2.1	Programming level A (operator level)	
9.1.2.2	Programming level B (technician level)	
9.1.2.3	Programming level C (special level)	
9.1.3	Reset	
9.2	User programming with the miniature operator's control panel (MOCP)	
9.2.1	Conditions for programming	
9.2.2	Enabling the programming mode	
9.2.3	Meaning of the various combinations of signals from H1 and H2	
9.2.4	To modify a parameter value	
9.2.5	Reset	
9.2.6	Binary code list for parameter values by programming with the MOCP	
10.	Start of operation	10.1 - 10.10
10.1	Start of the operation with the external operator's control panel OC-TOP	
10.1.1	Procedure for checking the direction of rotation and for the correct adjustment of the needle bar	
10.1.2	Control of the needle positions (NP1 / NP2 / NP3)	
10.1.3	Control of the positioning (angle) for thread trimming (parameter 705, 706)	
10.1.4	Procedure for checking maximum speed	
10.2	Start of operation using miniature operator's control panel - MOCP	
10.2.1	Procedure for checking the direction of rotation and for adjusting the reference position	
10.2.2	Procedure for checking the needle positions (NP1 / NP2 / NP3)	
10.2.3	Procedure for checking the (angular) position for thread trimming (parameter 705, 706)	
10.2.4	Procedure for checking maximum speed	
10.3	Hardware test	

Technical updatings reserved!

7. Construction and Description of the SERVO-TOP Drive System

The SERVO-TOP Drive System is an electronically commutated DC motor.

The system is composed of the following subassemblies (see Fig. 7.1)

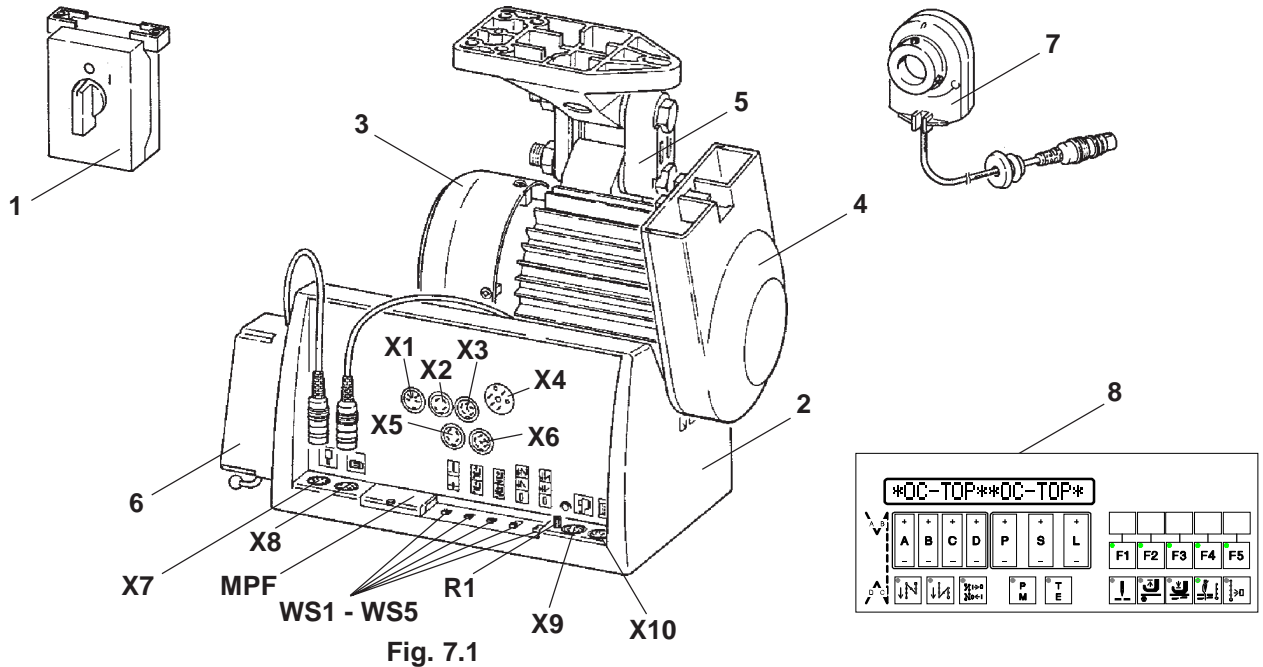

Fig. 7.1

- Basic motor (3) with mounting base and link (5) and with belt guard (4)
- Control box (2) with power electronics (DC intermediate circuit converter) and with control electronics specifically adapted for sewing machines
- Speed control unit (command unit) (6)
- Synchronizer (position control unit) (7)
- ON/OFF switch (mains power switch) (1)
- Operator panel (optional) (8)

7.1 Motor QE 5542

This is a synchronous motor with permanent magnet rotor and commutation transmitter

The rated power of the motor (shaft output power) is 550 W in operating mode S5. Rated speed is 4200 rpm, maximum speed is 5000 rpm.

Two connection cables are provided:

1. 4-conductor with AMP special plug for connecting the stator windings with the power board.
2. 6-conductor, shielded, with 6-contact Hirschmann plug for connecting the commutation transmitter with the control system.

7.2 Control System - Control Box

The control box is suspended from the basic motor and forms an integral part of the latter. Use two socket head hex screws M6 x 60 to attach the unit to the basic motor. Make electrical connections between control system and basic motor by means of the two cables provided on the latter.

Insert the 6-contact plug of the commutation transmitter into the correspondingly marked female connector (X8) on the lefthand front face.

To be able to insert the 4-contact AMP plug into the control system, open the cover on the rear side of the control box. Then slip the grommet with strain relief provided on the cable into the slot provided on the motor and secure with the nut provided.

Insert the 4-contact AMP plug into the female connector provided on the base board of the control system.

Description of the control System P40SE

The system is equipped with:

female connectors	X1 to X6 for connection of process elements (keys, switches, solenoids, solenoid valves) X7 for the speed control unit (command unit) X8 for the commutation transmitter of the motor X9 for the synchronizer (position control unit) X10 for an operator panel
selector switches	WS1 for needle position at sewing stop (down, up) WS2 for presser foot position at sewing stop (down, up) WS3 for presser foot position after seam end (down, up) WS4 for front backtack (none, single, double) WS5 for end backtack (none, single, double)
potentiometer	R1 for continuous reduction of the maximum machine speed as specified by parameter <607>.
miniature operator's control panel (MOCP)	for user programming of various control parameters.

The control system is connected with the sewing machine/ sewing equipment via:

inputs (Ex), such as for keys, switches, proximity switches, monitors, and

outputs (Ax), such as for solenoids, solenoid valves, signal indicators.

Inputs (Ex)

E1:	Feed reverse (manual backtack)	
E2:	Needle position change-over	if <616> = I ¹⁾
	Needle up without trimming	if <616> = II
E3:	Single stitch	if <617> = I
	Backtack function changeover	if <617> = II
E4:	Stop/ start lock	if <624> = I
	Presser foot	if <624> = II

¹⁾ <616> = I means that parameter 616 (the parameter number 616) is set to „I“.
<616> = II means that parameter 616 (the parameter number 616) is set to „II“.

Outputs (Ax)

A1:	Pneumatic thread trimmer
A2:	Magnetic thread trimmer
A3:	Thread wiper
A4:	Presser foot lift
A5:	Feed reverse
A7:	Presser foot down
A8:	Motor running

7.3 Speed Control Unit (Command Unit)

As a general rule, this unit is attached to the lefthand side of the control box by means of two screws and is mechanically connected by means of a pitman rod with the treadle located on the sewing machine stand.

Electrical connection is made by inserting the cable with 7-contact plug into the correspondingly marked female connector (X7) located on the lefthand front face of the control box.

The speed control unit is a mecano-electric converter, dividing the treadle stroke into 16 different digital values comprising 4 bits each.

To achieve this, the speed control unit is equipped with 4 signal tracks (A, B, C, D).

The 16 digital values are listed below together with the treadle stroke (treadle position) and with the uppertaining command.

Coding Chart of the Speed Control Unit:

Position:	Signals				Meaning
	A	B	C	D	
-2	0	1	1	0	Treadle heeled fully (seam end, SN)
-1	0	1	1	1	Treadle heeled slightly (PF lift)
0	1	1	1	1	Treadle zero position
+1	1	1	1	0	Treadle toed slightly (PF down)
+2	1	1	0	0	Speed step 1
+3	1	1	0	1	Speed step 2
+4	1	0	0	1	Speed step 3
+5	1	0	0	0	Speed step 4
+6	1	0	1	0	Speed step 5
+7	1	0	1	1	Speed step 6
+8	0	0	1	1	Speed step 7
+9	0	0	1	0	Speed step 8
+10	0	0	0	0	Speed step 9
+11	0	0	0	1	Speed step 10
+12	0	1	0	1	Speed step 11
+13	0	1	0	0	Speed step 12 (n-max treadle toed fully)

Pin connection of speed control plug

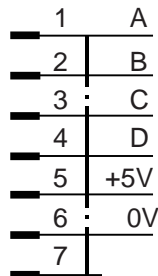

7.4 Synchronizer (Position Control Unit)

This unit is mechanically attached to the machine handwheel and is connected with the righthand front face of the control box by inserting a cable with a 6-contact plug into the female connector (X9) marked with the synchronizer symbol.

The synchronizer is a mechano-electric transducer (angular position transmitter) comprising a transmitter disk equipped with a signal track and a synchronization track. Signal generation is performed by photoelectric means via light barriers.

The signal track furnishes 480 pulses per revolution on two channels (FA, FB). The two pulse sequences are electrically phase-shifted by 90 degrees and thus permit recognition of the direction of rotation. The synchronization track furnishes one pulse per revolution having a width of 240 pulses furnished by the signal track.



The synchronizer is a precision instrument. To prevent malfunction, please do not open the unit!

Synchronization of the drive system and the machine is made with the synchronizer by a teach-in process within user programming (zero adjustment of the machine).

7.5 ON/OFF Switch (Power Connection Unit)

The switch unit should be attached to an appropriate place beneath the sewing machine table top.

The unit is supplied with two cables.

The first 3-conductor cable is provided for connection to the power mains by means of a locally used plug with earthing contact.

Introduce the other, shorter 3-conductor cable into the control box through the cable grommet with strain relief located above the rear cover. Connect the leads of this cable to the terminals on the base board and on the housing (PE).

The switch unit is designed for installation of up to three additional cable grommets with strain relief, permitting to connect further devices, such as a sewlight and a mains power outlet, to the ON/OFF switch.

To make additional connections, open the switch housing.

Proceed as follows:

- Loosen the retaining screw of the switch toggle
- Remove the toggle
- Insert a screwdriver into the bottom slot of the cover and release the retainer
- Remove the cover
- In order to make the terminals of the switch readily accessible, remove the switch from its fixed position.
This is easy to do. Just press the four retaining levers slightly outward by pairs.
Now the switch can easily be pulled out to the front.

7.6 External Operator Panel OC-TOP

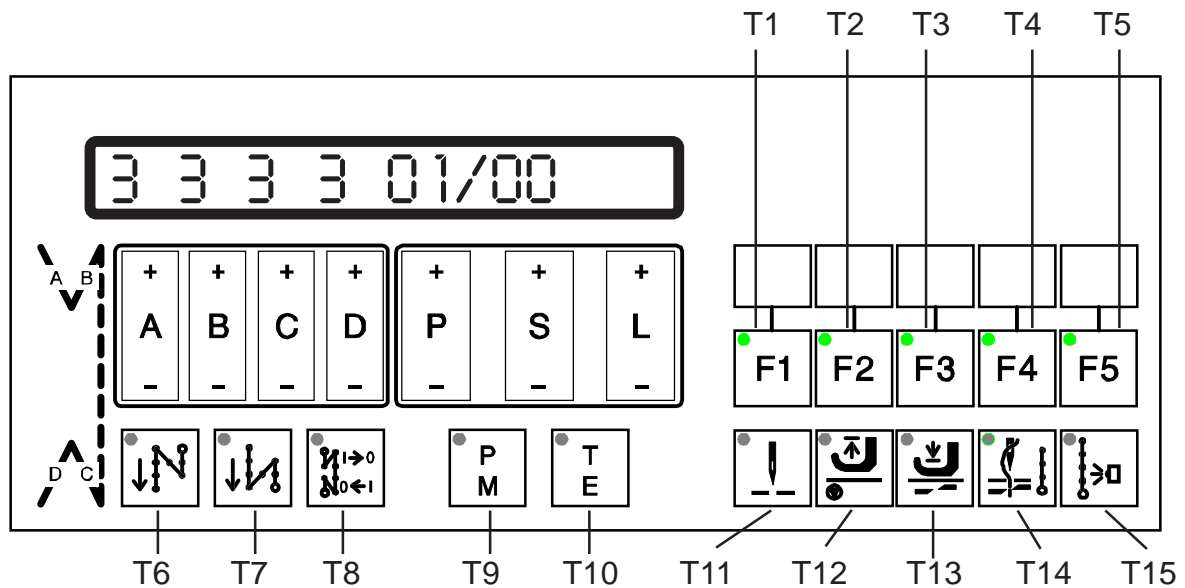

Fig. 7.2

The operator panel OC-TOP (Fig. 7.2) has the following components:

- a display: 16-digit LCD matrix
- 14 programming keys:
A+ / A-, B+ / B-, C+ / C-, D+ / D-, P+ / P-, S+ / S-, L+ / L-
- 2 keys for operating mode selection:
T9 (P/M) for change-over between programmed or manual sewing
T10 (T/E) for change-over between programming or sewing
- 8 keys with specified functional contents:
T6 for front backtack (on/off)
T7 for end backtack (on/off)
T8 for backtack inversion
T11 for needle position at sewing stop (up/down)
T12 for presser foot position at sewing stop (up/down)
T13 for presser foot position after seam end (up/down)
T14 for thread trimming (on/off)
T15 for sewing with light barrier (on/off)
- 5 keys (T1 ... T5) with their functional signification being specified by the control program (control software)
Meaning of keys T1 to T4 if key T5 is not pressed (dark):
T1 (F1) for linking seam sections (with/without)
T2 (F2) for speed control
constant (automatic) or
variable (treadle-controlled)
T3 (F3) feed reverse for a seam section
T4 (F4) seam section manual or stitchcounted
Meaning of keys T1 to T4 if key T5 is pressed (bright):
T1 currently no function
T2 currently no function
T3 single stitch
T4 unit count in display
- outlet for two light barriers on the rear of the OC-TOP

The keys T1 ... T15 are provided with one signal lamp each (LED). Each LED provides optical feedback on the control position of the function assigned to each key. If the function is ON, the LED is bright; if the function is OFF, the LED is dark.

8. Application

This SERVO-TOP drive can be used either with or without an external operator's control panel (OCP).

The following external operator's control panels can be used:

- OCP B2
- OCP OC-TOP

8.1 Sewing without an external operator's control panel

When working without an external operator's control panel the switches WS1 to WS5 are used.

The following functions can be called up via these switches:

WS1: Needle position (up/down) when stopping before seam end

WS2: Presser foot position (up/down) when stopping before seam end

WS3: Presser foot position (up/down) after seam end

WS4: Initial backtack: without / single / double

WS5: End backtack: without / single / double.

8.2 Sewing with the external operator's control panel B2

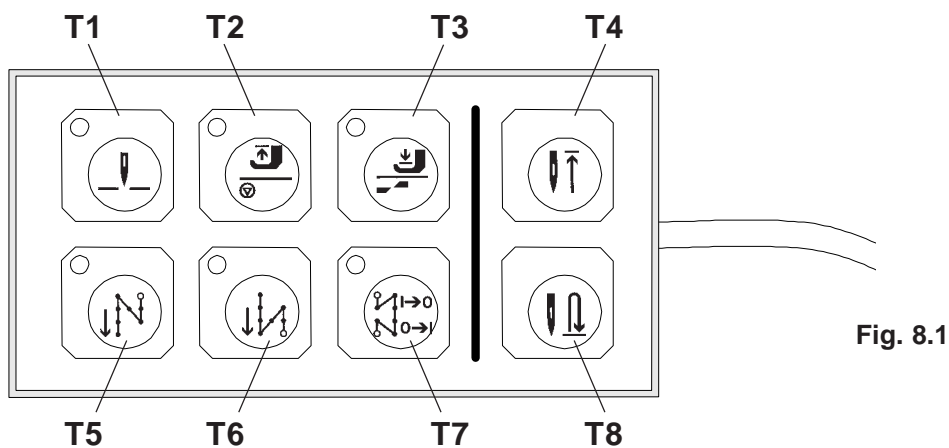

Fig. 8.1

If the SERVO-TOP is used with the OCP B2, then only the manual sewing work option is available.

The following functions can be called up via the keys of the OCP B2:

T1: Needle position when the machine stopped before end of the seam

up: (LED switched on)

down: (LED switched off)

T2: Position of the presser foot when the machine is stopped before the end of the seam

up: (LED switched on)

down: (LED switched off)

- T3:** Position of the presser foot after the end of the seam
up: (LED switched on)
down: (LED switched off)
- T4:** Needle up without trimming
- T5:** Initial backtack
on: (LED switched on)
off: (LED switched off)
- T6:** End backtack
on: (LED switched on)
off: (LED switched off)
- T7:** Backtack inversion or elimination
If this key is pressed (LED switched on), before the start of the seam length, then from the start of the seam length the opposite function to what is indicated on key T5 will be effected.
- If this key is pressed during sewing (LED switched on) then the opposite function to what is indicated on key T6 will be effected at the end of the seam length.
- T8:** Single stitch
When this key is pressed, the machine will perform one extra stitch.

The actual position of each function is indicated by the LEDs which are built into each key.

The type of backtack - single or double - will be chosen by the selector switches WS4 and WS5 at the front of the control box.

The other function selecting switches (WS1, WS2, WS3) at the front of the control box are without effect.

Indication of defective functions at the OCP B2:

Functions that are inoperative or defective in the drive or only in the control box will be indicated via the LEDs in the keys.

There are two signal positions which indicate these malfunctions :

- a) The 3 upper LEDs and the 3 lower LEDs blink alternatively.
The malfunction is in the area of malfunction number < 63 (see section 8.4).
- b) All 6 LEDs blink at the same time.
The malfunction is in the area of malfunction number > 64 (see section 8.4).

8.3 Sewing with External Operator's Control Panel OC-TOP

8.3.1 Sewing without Sewing Program (manual Sewing)

Condition: key T9 (P/M) is dark
key T10 (T/E) is dark

Display showing

- before start or after start, when <605> = II



rated backtack stitchcount
sewing program activated when
key T9 (P/M) is pressed (bright)

Setting of rated backtack stitchcount is possible only with the machine at standstill

- for front backtack forward with key A+ or key A-,
- for front backtack backward with key B+ or key B-,
- for end backtack backward with key C+ or key C-,
- for end backtack forward with key D+ or key D-.

Display showing

- before start, when <605> = I



actual speed
symbol for actual
speed

8.3.2 Sewing with Sewing Program - Programmed Sewing, General

Condition: key T9 (P/M) is bright
key T10 (T/E) is dark

Display showing before start



rated speed
subsequent sewig
program
sewing program
seam section (□□ = before start)
cycles (sequences of program)

When this is displayed, the following can be modified:

- program: by actuating key P+ or P-
- seam section: by actuating key S+ or S-
- cycles: by actuating key L+ or L-
- the subsequent sewing program via key D+ or D-
- rated speed for the program: by actuating key A+ or A-
This speed is limited by parameter <221>

Display before start if a seam section has been activated

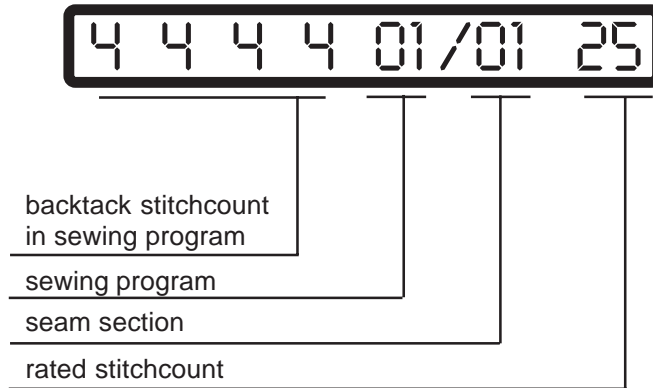

When this is displayed, the following can be modified:

- the preset backtack stitchcount for the program by actuating the keys located below the respective digits
- rated stitchcount of a seam section: by actuating key L+ or L-
- program: by actuating key P+ or P-
- seam section: by actuating key S+ or S-

Display showing after start, when <605> = II



Display showing after start, when <605> = I

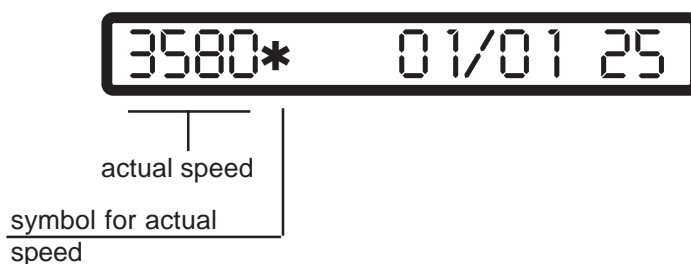

Sewing programs

- a) 5 sewing programs can be used
- b) The sewing programs comprise up to 5 seam sections
- c) Each seam section can comprise up to 99 stitches
- d) The following functions can be assigned to each seam section:

front backtack	via key T6
end backtack	via key T7
needle position at sewing stop	via key T11
presser foot position at sewing stop	via key T12
presser foot position after completion of seam section	via key T13
thread trimming	via key T14
feed reverse	via key T3
- e) Linking consecutive seam sections can be made via key T1
- f) Sewing speed can be chosen to be either constant (automatic) or variable (treadle-controlled) via key T2.
- g) The stitchcount of a seam section can be interrupted via treadle position -2. This condition is signalled by the letter 'f' shown in the display. Manual sewing (without stitchcount) is now possible until the seam section is completed by renewed treadle position -2 and the program advancing to the subsequent seam section.
- h) Seam sections can also be performed without stitchcount; stitchcount deactivation is made via key T4
- i) In sewing with light barrier control, the rated stitchcounts stored for the seam section are light barrier compensation stitches.
- j) It is possible to run several sewing programs consecutively. During programming, the subsequent program is displayed by digits 6 and 7 and can be entered via key D+ and D-.
□□ means that the current program will be performed exclusively; at its end return is made to its start.
- k) The programs can be used as backtack/darn programs
Change-over is made via parameter <313>

8.3.3 Backtack/Darning Programs

- The sewing programs are turned into backtack/darning programs when parameter <313> = 1.
- In each program, only seam sections 1 and 2 become active, section 1 being sewn forward and section 2 backward.
- The cycle counter (shown on the righthand side of the display above keys L+/L- before sewing start) determines the number of backtacks (single, double, 3 times, 4 times).
- The darning program is a special backtack program. In this case, reset the cycle counter to "0".
- Seam end is initiated in the darning program by treadle position "-2".
- Five backtack/darning programs are available.
- Each program has one of the five function keys T1 ... T5 assigned to it.

- The activated program is indicated on the display above keys P+/P- and/or by the assigned key T1 ... T5 being luminous.
- On the lefthand side of the display, the preset maximum speed possible in the program is shown before sewing start. This speed can be varied via the keys A+/A- and can be limited via parameter <221>.
- The backtack/darning programs can be operated either at variable (treadle-controlled) or constant speed (not controlled by the treadle).
- Sewing at constant speed:
With <313> = II, switch on key T2 (luminous) during the seam sections, subsequently set <313> = I; this means backtack/darning program activated.
- Stitch compensation is activated via parameter 304. Its value (<304>) determines delayed deactivation (ms) of the feed reverse after seam section 2.

8.4 Error Messages (Malfunction Diagnostics)

The control system of the drive cyclically tests its own functional condition and the functional condition of the complete drive system.

Malfunctions are signalled via the display of the external operator panel, for instance:



List of possible error codes:

- | | |
|-----|--|
| 1 | Treadle not in zero position when mains power is turned ON |
| 9 | Start lock |
| 10 | Machine class, <799> was changed; remedy: turn mains power switch OFF and ON again |
| 62 | Short circuit on 24 V (32 V) DC |
| 63 | Overload on 24 V (32 V) DC, load current > 4 amps |
| 64 | Power supply monitor: voltage too low (90 V - 150 V) |
| 65 | Power electronics not operational after mains power ON, mains power < 130 V |
| 66 | Earth short (motor or motor supply line has earth short in one or more phases) |
| 67 | Internal malfunction |
| 68 | Power electronics shut-off |
| | a) Overcurrent, short circuit in motor or supply line |
| | b) Overvoltage, mains voltage too high (>300 V), motor overloaded while decelerating |
| | c) Undervoltage |
| 69 | Synchronizer not furnishing increments |
| | a) Synchronizer plug not inserted |
| | b) Belt not in place or belt tension insufficient |
| 70 | Machine blocked, no increment from synchronizer at max. motor torque |
| 71 | Commutation transmitter plug not inserted |
| 72 | Synchronizer plugged into commutation transmitter connector |
| 73 | Motor overloaded |
| 75 | Internal malfunction |
| 90 | EEPROM does not exist |
| 91 | EEPROM not programmable |
| 92 | Start lock while motor running |
| 93 | Wrong EEPROM |
| 100 | } Internal malfunction |
| 117 | |

In case of error messages ≥ 62 , the motor will stop in undefined positions.

Control system reset possible only by mains power OFF/ON.

9. Programming by the User

Enables machine functions and parameters to be switched on or set up.

User programming of the **SERVO-TOP** can be carried out via

- external operator's control panel OC-TOP
- or
- the miniature integrated control panel

The user programming of the **SERVO-TOP** is possible by means of an external operator's control panel via:

- direct programming (only with drives from function level 40) and/or
- programming parameters.

The programming of parameters is possible via three levels of program:

- Programming on level A (operator level)
- Programming on level B (technician's level)
- Programming on level C (special level)

9.1 User Programming with Operator Panel OC-TOP

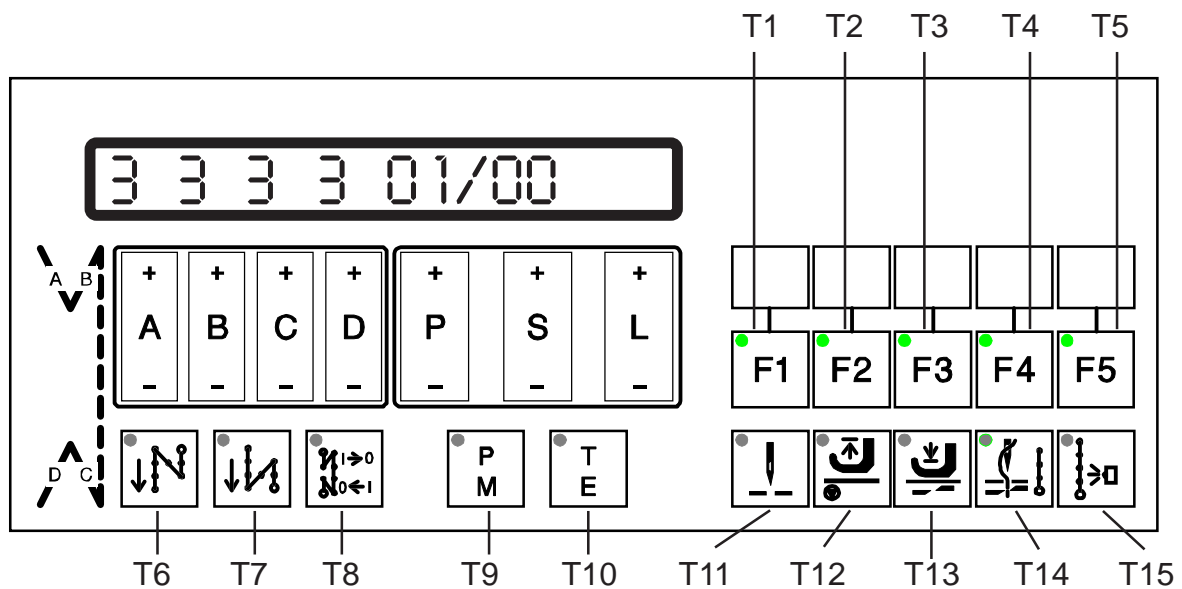

Fig. 9.1

9.1.1 Direct Programming

Attention!

All values modified within direct programming are stored only when

a) the drive system is started or

b) key T9 (P/M) are pressed.

If the drive system is switched off via the mains power switch immediately after any values were modified, the values set before modification will be retained!

Regardless of the programming levels, certain values can be programmed without calling up parameter numbers - i.e. directly.

The following values can be modified by direct programming:

Front backtack stitchcount forward

Front backtack stitchcount backward

End backtack stitchcount backward

End backtack stitchcount forward

Stitchcounts for seam sections

Speeds for seam sections

Functions for seam sections

a) Modification of backtack stitchcounts

Display shown when "manual sewing" is ON (T9 (P/M) and T10 (T/E) not luminous)



A digital display showing the value '3 3 3 3 0x/00' in a seven-segment font. The display is enclosed in a rectangular border.

Display shown when "programmed sewing" is ON (T9 (P/M) luminous, T10 (T/E) not luminous)



A digital display showing the value '4 4 3 3 0x/01 25' in a seven-segment font. The display is enclosed in a rectangular border.

The symbolic seam pictogram on the lefthand side of the operator panel shows the backtack sections

A: Front backtack forward

B: Front backtack backward

C: End backtack backward

D: End backtack forward

Immediately below the display, there are keys

A+/A- for backtack section A,

B+/B- for backtack section B,

C+/C- for backtack section C,

D+/D- for backtack section D

These keys permit to increase or decrease the backtack stitchcounts.

b) Programming of the Stitchcount for a Seam Section

Condition: Operation mode „programmed sewing“ is on, i.e. key T9 (P/M) is bright and key T10 (T/E) is dark, machine not sewing

Display showing

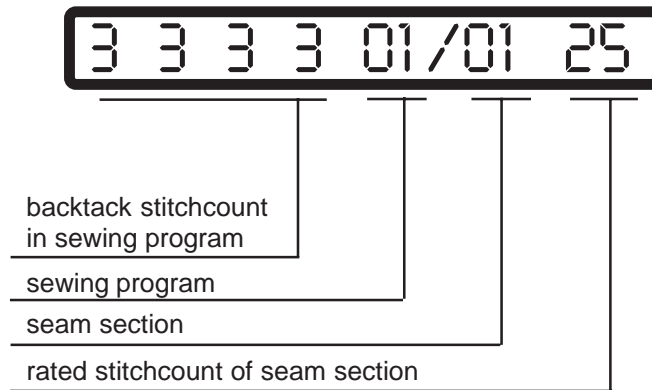

Activation of a sewing program is made via keys P+ or P-

Activation of a seam section is made via keys S+ or S-

Programming of the stitchcount for the seam section is made via key L+ (value increased) or L- (value decreased)

c) Programming of Seam Sections by „Teach-in“ (Performing Work)

Condition: Key T9 (P/M) is bright
Key T10 (T/E) is bright

The machine must have performed at least one stitch before.

Activate the desired program in the display via keys P+ or P- and the seam section to be programmed via keys S+ or S-.

Cycle:

- a) Treadle forward
Reaction: the stitchcount which has been registered up to now will be eliminated
- b) Treadle returns to zero position
- c) Treadle forward
Reaction: machine sews, the sewed stitches will be added in, shown in the display and registered

Correction of the value shown in the display is possible via key L+ or L-.

d) Programming of Cycles (Number of Sequences of Program), of Program Speed and of the subsequent Program

Condition: Operation mode „programmed sewing“ is on, i.e. key T9 (P/M) is bright and key T10 (T/E) is dark, machine not sewing

Display showing

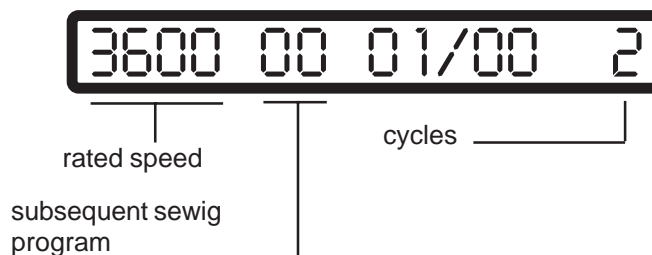

Cycle programming is made via the keys L+ (number increased) or L- (number decreased)

Programming of the speed for the program is made via key A+ (value increased) or A- (value decreased)
This speed is limited by parameter <221>

Programming of the subsequent sewing program is made via keys D+ or D-.

e) Programming of Functions

Functions for the seam sections are controlled via the functional keys

- T6 Front backtack or start stitch condensation (with/without)
- T7 End backtack or end stitch condensation (with/without)
- T11 Needle position at sewing stop and at the end of a seam section (up/down)
- T12 Presser foot position at sewing stop (up/down)
- T13 Presser foot position at the end of a seam section (up/down)
- T14 Thread trimming at the end of a seam section (with/without)
- T15 Sewing with light barrier (with/without)
- T1 Linking of seam section (with/without), if T5 is dark
- T2 Speed control, if T5 is dark
variable (treadle-controlled, T2 is dark) or
constant (automatic, T2 is bright)
- T3 Transport reverse or stitch condensation of a seam section, if T5 is dark
- T4 Seam section manual or stitchcounted, if T5 is dark

9.1.2 Parameter Programming

9.1.2.1 Programming Level A (Operator Level)

This level is used for programming control parameters which immediately affect the operation sequence.

These are the parameters for the following functions:

- Front backtack (double or single) <148>
- End backtack (double or single) <149>
- Backtack (standard backtack or decorative backtack) <523>
- Light barrier compensation stitches <111>
- Light barrier fade-out <112>
- Softstart <116>

a) Activation of Programming Level A

Conditions

Mains power switch ON

Drive system not running

Operating mode: manual sewing must be ON (key T9 (P/M) dark)



Press key T10 (T/E)

Response:

Key T10 (T/E) becomes bright, the display shows in its righthand half the first parameter (parameter no. and parameter value) associated with programming level A.

Sewing is not possible



- Programming
The parameter number is set by using keys P+ or P- (hundreds of parameter no.) and keys S+ or S- (tens and units of parameter no.). The parameter value is programmed by using key L+ or L-

b) Deactivation of the Programming Level A

Press key T10 (T/E)

Response:

Key T10 (T/E) goes dark, the display returns to initial condition.
Sewing is possible.

A digital display with a black border showing the text "3 3 3 3 0x/00". The first four digits are "3 3 3 3" and the last two are "0x/00".

9.1.2.2 Programming Level B (Technician Level)

This level is used for programming the control parameters which have to be modified or adapted very rarely or only for starting operation of the system.

a) Preparation for activation of the programming level B

Turn mains power switch OFF
Press and hold keys T9 (P/M) and T10 (T/E) simultaneously
Turn mains power switch ON
Release keys

Response:

The display shows a „*“ between program and seam section.
Sewing is possible.

A digital display with a black border showing the text "3 3 3 3 0x*00". The first four digits are "3 3 3 3" and the last two are "0x*00".

b) Activation of programming level B

Press key T9 (P/M) (not becoming bright) and press key T10 (T/E) (becoming bright)

Response:

In the righthand half of the display are shown: a parameter number (at first 104, then the number selected last) and the associated value.

Sewing is not possible.

A digital display with a black border showing the text "3 3 3 3 104 8". The first four digits are "3 3 3 3", followed by "104" and "8".

Modification of parameter number:

for hundreds of parameter numbers use key P+ or P-
for tens and units of parameter numbers use key S+ or S-

Modification of parameter value: via key L+ or L-

c) Deactivation of programming level B

Press key T10 (T/E) (not becoming bright)

Response:

Parameters shown disappear from the display, the display returns to initial condition
Sewing is possible.



9.1.2.3 Programming Level C (Special Level)

At this level, control parameters are stored the values of which have to be modified in exceptional cases only. Correction of these parameters should therefore be made only after consultation of the manufacturer.

Activation of programming level C

- a) Activate programming level B (see 9.1.2.2)
- b) Call up parameter 798
- c) Set parameter value <798> to I
- d) Deactivate programming level B
- e) Turn mains power switch OFF, wait for >2 secs. to elapse
- f) Turn mains power switch back ON
- g) Press key T10 (T/E) (becoming bright)

Response:

In the righthand half of the display appears the first parameter of programming level C.

Calling up further parameter numbers and correcting the parameter values can be made in the same way as described for programming levels A and B.

Deactivation of programming level C:

- Press key T10 (T/E) (not becoming bright)
- Turn mains power switch OFF

9.1.3 Reset

a) Reset of Parameter Values

All parameter values having been modified from the ex-factory condition (standard value) are reset to their standard values by this procedure.

Exceptions: parameters 700, 799 and 800
For these parameters, the values programmed by the user are retained even after -Reset- has been performed.

-Reset- procedure:

- turn mains power switch OFF
- press treadle fully forward and hold in that position

- press and hold keys P- or P+, S- or S+ and L- or L+ simultaneously
- turn mains power switch ON
- release the three keys and the treadle

Response: Display showing

The LCD display shows the text "RESET Y -- N" in a monospaced font, with "Y" and "--" separated by a space.

Now -Reset- can be performed.

Located below the display Y (yes) there is key P+. Press this key P+ to start the reset. The display briefly shows:

The LCD display shows the text "MASTER-RESET" in a monospaced font.

After that the display shows the power-on display for approx. 2 secs.

The LCD display shows the text "X40SE 27.011.4" in a monospaced font, with "27.011.4" separated by a space.

and then shows the display corresponding to the operating mode selected

The LCD display shows the text "3 3 3 3 0x/00" in a monospaced font, with "0x/00" separated by a space.

If it is not desired to start the -Reset-, press key L+ located below the display saying N (no).

b) Reset of Parameter Values and Sewing Programs

The reset procedure including the data of the sewing programs is analog to that described under a), until the following appears in the display:

The LCD display shows the text "RESET Y -- N" in a monospaced font, with "Y" and "--" separated by a space.

In order to reset the data of the sewing programs to their original values, it is now required before pressing key P+ to press at first key T8 and hold until activation is acknowledged in the display.

9.2 User programming with the miniature operator's control panel (MOCP)

The MOCP is at the front of the control box cover near the switches for selection of the various functions (see fig. 9.2) and it is protected with a plastic cover. In order to obtain access to the MOCP, the cover must be removed. To do this loosen the screw in the cover and slide it to one side.



Warning: The person who removes this cover must first touch an unpainted metal surface!

At the end of the programming phase, screw the plastic cover back into position.

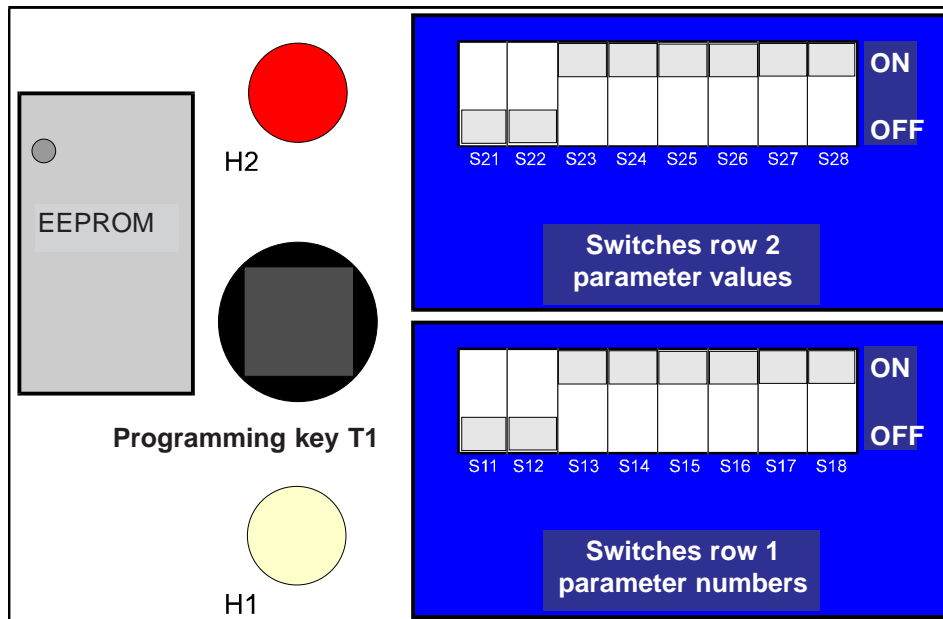

fig. 9.2

The miniature programming field (see fig. 9.2) consists of:

- Switches row 1 (front) comprising switches S11 ... S18 for setting the parameter numbers.
- Switches row 2 (rear) comprising switches S21 ... S28 for setting the parameter values.
- Programming key T1
- Signal LEDs H1 (front) and H2 (rear)

9.2.1 Conditions for programming

- Drive system must be ON
- Motor must be at standstill
- The external operator's panel should not be plugged in

9.2.2 Enabling the programming mode

The parameter codes that can be adjusted at the switches row 1 can be found in the list of parameters (chapter 11.4).

Attention! In order to call up the parameter number which indicates the type of program (change in the value of parameter) or which controls the value of the parameter on row 1 must be programmed, you press key T1!

- Press and hold key T1
Response: LEDs H1 and H2 light up

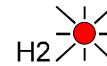

- Release key T1
Response: LEDs H1 and H2 indicate one of the following combinations

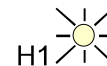

9.2.3 Meaning of the various combinations of signals from H1 and H2

Option 1	H1 off, H2 on parameter no. (key row 1) does not exist	
Option 2	H1 on, H2 off parameter no. (key row 1) exists parameter value (key row 2) does not exist (is outside the range of values)	
Option 3	H1 on, H2 blinks parameter value (key row 2) is larger than the memorized value.	
Option 4	H1 blinks, H2 on parameter value (key row 2) is smaller than the memorized value.	
Option 5	H1 on, H2 on parameter value (key row 2) is the same as the memorized value.	
Option 6	H1 blinks, H2 blinks parameter no (key row 1) is an basic parameter, key row 2 has in this case no value.	

9.2.4 To modify a parameter value, proceed as follows:

- Set the parameter no. on switches row 1 as per the preestablished code (as per parameter list)
- Set the desired parameter value on switches row 2 in binary code.
Note: Position for minimum value is lefthand.
- 8 binary switch elements can be used to make up numbers from 0 to 255 in a coded scheme.
- Coding of numbers (setting of switches in row 2) can be seen from the attached chart.
- **Setting of values > 255:**

<u>Parameter</u>	<u>Range</u>	<u>Increment</u>
105	100 ... 6400	100
110	100 ... 6400	
607	100 ... 10000	

The parameters set on switches row 2 are reduced 100 times, i.e. set value

1 = 100 rpm
100 = 10.000 rpm.

<u>Parameter</u>	<u>Range</u>	<u>Increment</u>
117	30 ... 400	10
606	30 ... 640	
609	30 ... 640	

The parameters set on switches row 2 are reduced 10 times, i.e. set value

3 = 30 rpm
64 = 640 rpm

<u>Parameter</u>	<u>Range</u>	<u>Increment</u>
623	0 ... 2550	10
714		
715		

The parameters set on switches row 2 are reduced 10 times, i.e. set value

1 = 10 ms
100 = 1000 ms
255 = 2550 ms.

- LEDs H1 and H2 must indicate condition (option) 3 or 4 or 5, i.e. permissible parameter value.
- To store the new parameter value, press key T1 for a minimum time of 0.8 seconds
During these 0.8 seconds, both LEDs will blink at a fast rate. Subsequently, both will be activated (both are lit) until the key is released.
After approx. 2 seconds, both LEDs will flash up to indicate that the new parameter value has been stored. This now means that the drive system is operational, programming mode has been deactivated.
- To leave the programming mode without correcting any values, proceed as follows:
Press key T1 and release before 0.8 s have elapsed.

- Change-over of software switches (i.e. of parameters not having more than 2 values)
For these parameter values, the only effective selector is switch S21 (switch row 2, first switch from left)! The switches from S22 to S28 must be in the "OFF" position.

9.2.5 Reset

All parameter values which have been altered can be returned to their original value as set in our factory. To obtain this, proceed as follows:

- switch off the motor
- press the treadle full forward and hold it in this position, press key T1 and hold it in the pressed position while switching on the drive.

Reaction: both LEDs light up to indicate that the reset has started.
2 seconds later both LEDs switch off to indicate that the reset is finished.

Result: all parameters are reset except for <700>, <799> and <800> which remain unaltered

- release key T1
- return treadle to the neutral position

9.2.6 Binary code list for parameter values by programming with the MOCP (see next page)

- | | | | | | |
|----|-----------------|----|-----------------|----|-----------------|
| 0 | 0 0 0 0 0 0 0 0 | 25 | 1 0 0 1 1 0 0 0 | 50 | 0 1 0 0 1 1 0 0 |
| 1 | 1 0 0 0 0 0 0 0 | 26 | 0 1 0 1 1 0 0 0 | 51 | 1 1 0 0 1 1 0 0 |
| 2 | 0 1 0 0 0 0 0 0 | 27 | 1 1 0 1 1 0 0 0 | 52 | 0 0 1 0 1 1 0 0 |
| 3 | 1 1 0 0 0 0 0 0 | 28 | 0 0 1 1 1 0 0 0 | 53 | 1 0 1 0 1 1 0 0 |
| 4 | 0 0 1 0 0 0 0 0 | 29 | 1 0 1 1 1 0 0 0 | 54 | 0 1 1 0 1 1 0 0 |
| 5 | 1 0 1 0 0 0 0 0 | 30 | 0 1 1 1 1 0 0 0 | 55 | 1 1 1 0 1 1 0 0 |
| 6 | 0 1 1 0 0 0 0 0 | 31 | 1 1 1 1 1 0 0 0 | 56 | 0 0 0 1 1 1 0 0 |
| 7 | 1 1 1 0 0 0 0 0 | 32 | 0 0 0 0 0 1 0 0 | 57 | 1 0 0 1 1 1 0 0 |
| 8 | 0 0 0 1 0 0 0 0 | 33 | 1 0 0 0 0 1 0 0 | 58 | 0 1 0 1 1 1 0 0 |
| 9 | 1 0 0 1 0 0 0 0 | 34 | 0 1 0 0 0 1 0 0 | 59 | 1 1 0 1 1 1 0 0 |
| 10 | 0 1 0 1 0 0 0 0 | 35 | 1 1 0 0 0 1 0 0 | 60 | 0 0 1 1 1 1 0 0 |
| 11 | 1 1 0 1 0 0 0 0 | 36 | 0 0 1 0 0 1 0 0 | 61 | 1 0 1 1 1 1 0 0 |
| 12 | 0 0 1 1 0 0 0 0 | 37 | 1 0 1 0 0 1 0 0 | 62 | 0 1 1 1 1 1 0 0 |
| 13 | 1 0 1 1 0 0 0 0 | 38 | 0 1 1 0 0 1 0 0 | 63 | 1 1 1 1 1 1 0 0 |
| 14 | 0 1 1 1 0 0 0 0 | 39 | 1 1 1 0 0 1 0 0 | 64 | 0 0 0 0 0 0 1 0 |
| 15 | 1 1 1 1 0 0 0 0 | 40 | 0 0 0 1 0 1 0 0 | 65 | 1 0 0 0 0 0 1 0 |
| 16 | 0 0 0 0 1 0 0 0 | 41 | 1 0 0 1 0 1 0 0 | 66 | 0 1 0 0 0 0 1 0 |
| 17 | 1 0 0 0 1 0 0 0 | 42 | 0 1 0 1 0 1 0 0 | 67 | 1 1 0 0 0 0 1 0 |
| 18 | 0 1 0 0 1 0 0 0 | 43 | 1 1 0 1 0 1 0 0 | 68 | 0 0 1 0 0 0 1 0 |
| 19 | 1 1 0 0 1 0 0 0 | 44 | 0 0 1 1 0 1 0 0 | 69 | 1 0 1 0 0 0 1 0 |
| 20 | 0 0 1 0 1 0 0 0 | 45 | 1 0 1 1 0 1 0 0 | 70 | 0 1 1 0 0 0 1 0 |
| 21 | 1 0 1 0 1 0 0 0 | 46 | 0 1 1 1 0 1 0 0 | 71 | 1 1 1 0 0 0 1 0 |
| 22 | 0 1 1 0 1 0 0 0 | 47 | 1 1 1 1 0 1 0 0 | 72 | 0 0 0 1 0 0 1 0 |
| 23 | 1 1 1 0 1 0 0 0 | 48 | 0 0 0 0 1 1 0 0 | 73 | 1 0 0 1 0 0 1 0 |
| 24 | 0 0 0 1 1 0 0 0 | 49 | 1 0 0 0 1 1 0 0 | 74 | 0 1 0 1 0 0 1 0 |

75	1 1 0 1 0 0 1 0	100	0 0 1 0 0 1 1 0	125	1 0 1 1 1 1 1 0
76	0 0 1 1 0 0 1 0	101	1 0 1 0 0 1 1 0	126	0 1 1 1 1 1 1 0
77	1 0 1 1 0 0 1 0	102	0 1 1 0 0 1 1 0	127	1 1 1 1 1 1 1 0
78	0 1 1 1 0 0 1 0	103	1 1 1 0 0 1 1 0	128	0 0 0 0 0 0 0 1
79	1 1 1 1 0 0 1 0	104	0 0 0 1 0 1 1 0	129	1 0 0 0 0 0 0 1
80	0 0 0 0 1 0 1 0	105	1 0 0 1 0 1 1 0	130	0 1 0 0 0 0 0 1
81	1 0 0 0 1 0 1 0	106	0 1 0 1 0 1 1 0	131	1 1 0 0 0 0 0 1
82	0 1 0 0 1 0 1 0	107	1 1 0 1 0 1 1 0	132	0 0 1 0 0 0 0 1
83	1 1 0 0 1 0 1 0	108	0 0 1 1 0 1 1 0	133	1 0 1 0 0 0 0 1
84	0 0 1 0 1 0 1 0	109	1 0 1 1 0 1 1 0	134	0 1 1 0 0 0 0 1
85	1 0 1 0 1 0 1 0	110	0 1 1 1 0 1 1 0	135	1 1 1 0 0 0 0 1
86	0 1 1 0 1 0 1 0	111	1 1 1 1 0 1 1 0	136	0 0 0 1 0 0 0 1
87	1 1 1 0 1 0 1 0	112	0 0 0 0 1 1 1 0	137	1 0 0 1 0 0 0 1
88	0 0 0 1 1 0 1 0	113	1 0 0 0 1 1 1 0	138	0 1 0 1 0 0 0 1
89	1 0 0 1 1 0 1 0	114	0 1 0 0 1 1 1 0	139	1 1 0 1 0 0 0 1
90	0 1 0 1 1 0 1 0	115	1 1 0 0 1 1 1 0	140	0 0 1 1 0 0 0 1
91	1 1 0 1 1 0 1 0	116	0 0 1 0 1 1 1 0	141	1 0 1 1 0 0 0 1
92	0 0 1 1 1 0 1 0	117	1 0 1 0 1 1 1 0	142	0 1 1 1 0 0 0 1
93	1 0 1 1 1 0 1 0	118	0 1 1 0 1 1 1 0	143	1 1 1 1 0 0 0 1
94	0 1 1 1 1 0 1 0	119	1 1 1 0 1 1 1 0	144	0 0 0 0 1 0 0 1
95	1 1 1 1 1 0 1 0	120	0 0 0 1 1 1 1 0	145	1 0 0 0 1 0 0 1
96	0 0 0 0 0 1 1 0	121	1 0 0 1 1 1 1 0	146	0 1 0 0 1 0 0 1
97	1 0 0 0 0 1 1 0	122	0 1 0 1 1 1 1 0	147	1 1 0 0 1 0 0 1
98	0 1 0 0 0 1 1 0	123	1 1 0 1 1 1 1 0	148	0 0 1 0 1 0 0 1
99	1 1 0 0 0 1 1 0	124	0 0 1 1 1 1 1 0	149	1 0 1 0 1 0 0 1

150	0 1 1 0 0 0 1	175	1 1 1 1 0 0 1	200	0 0 0 1 0 0 1 1
151	1 1 1 0 0 0 1	176	0 0 0 0 1 1 0 1	201	1 0 0 1 0 0 1 1
152	0 0 0 1 1 0 0 1	177	1 0 0 0 1 1 0 1	202	0 1 0 1 0 0 1 1
153	1 0 0 1 1 0 0 1	178	0 1 0 0 1 1 0 1	203	1 1 0 1 0 0 1 1
154	0 1 0 1 1 0 0 1	179	1 1 0 0 1 1 0 1	204	0 0 1 1 0 0 1 1
155	1 1 0 1 1 0 0 1	180	0 0 1 0 1 1 0 1	205	1 0 1 1 0 0 1 1
156	0 0 1 1 1 0 0 1	181	1 0 1 0 1 1 0 1	206	0 1 1 1 0 0 1 1
157	1 0 1 1 1 0 0 1	182	0 1 1 0 1 1 0 1	207	1 1 1 1 0 0 1 1
158	0 1 1 1 1 0 0 1	183	1 1 1 0 1 1 0 1	208	0 0 0 0 1 0 1 1
159	1 1 1 1 1 0 0 1	184	0 0 0 1 1 1 0 1	209	1 0 0 0 1 0 1 1
160	0 0 0 0 0 1 0 1	185	1 0 0 1 1 1 0 1	210	0 1 0 0 1 0 1 1
161	1 0 0 0 0 1 0 1	186	0 1 0 1 1 1 0 1	211	1 1 0 0 1 0 1 1
162	0 1 0 0 0 1 0 1	187	1 1 0 1 1 1 0 1	212	0 0 1 0 1 0 1 1
163	1 1 0 0 0 1 0 1	188	0 0 1 1 1 1 0 1	213	1 0 1 0 1 0 1 1
164	0 0 1 0 0 1 0 1	189	1 0 1 1 1 1 0 1	214	0 1 1 0 1 0 1 1
165	1 0 1 0 0 1 0 1	190	0 1 1 1 1 1 0 1	215	1 1 1 0 1 0 1 1
166	0 1 1 0 0 1 0 1	191	1 1 1 1 1 1 0 1	216	0 0 0 1 1 0 1 1
167	1 1 1 0 0 1 0 1	192	0 0 0 0 0 0 1 1	217	1 0 0 1 1 0 1 1
168	0 0 0 1 0 1 0 1	193	1 0 0 0 0 0 1 1	218	0 1 0 1 1 0 1 1
169	1 0 0 1 0 1 0 1	194	0 1 0 0 0 0 1 1	219	1 1 0 1 1 0 1 1
170	0 1 0 1 0 1 0 1	195	1 1 0 0 0 0 1 1	220	0 0 1 1 1 0 1 1
171	1 1 0 1 0 1 0 1	196	0 1 0 0 0 0 1 1	221	1 0 1 1 1 0 1 1
172	0 0 1 1 0 1 0 1	197	1 0 1 0 0 0 1 1	222	0 1 1 1 1 0 1 1
173	1 0 1 1 0 1 0 1	198	0 1 1 0 0 0 1 1	223	1 1 1 1 1 0 1 1
174	0 1 1 1 0 1 0 1	199	1 1 1 0 0 0 1 1	224	0 0 0 0 0 1 1 1

225 | 1 0 0 0 0 | | | |
226 | 0 | 0 0 0 | | | |
227 | | 1 0 0 0 | | | |
228 | 0 0 | 1 0 0 | | | |
229 | | 1 0 | 1 0 0 | | | |
230 | 0 | | 1 0 0 | | | |
231 | | | 1 0 0 | | | |
232 | 0 0 0 | 1 0 | | | |
233 | | 1 0 0 | 1 0 | | | |
234 | 0 | 1 0 | 1 0 | | | |
235 | | 1 | 1 0 | 1 0 | | | |
236 | 0 0 | 1 | 1 0 | | | |
237 | | 1 0 | 1 | 1 0 | | | |
238 | 0 | 1 | 1 | 1 0 | | | |
239 | | 1 | 1 | 1 | 0 | | | |
240 | 0 0 0 0 | | | | |
241 | | 1 0 0 0 | | | | |
242 | 0 | 1 0 0 | | | | |
243 | | 1 | 1 0 0 | | | | |
244 | 0 0 | 1 0 | | | | |
245 | | 1 0 | 1 0 | | | | |
246 | 0 | 1 | 1 0 | | | | |
247 | | 1 | 1 | 1 0 | | | | |
247 | 0 0 0 | 1 | 1 | 1 | | | |
249 | | 1 0 0 | 1 | 1 | 1 | | | |

250 | 0 | 0 | 1 | 1 | 1 | 1 |
251 | | 1 | 1 0 | 1 | 1 | 1 | 1 |
252 | 0 0 | 1 | 1 | 1 | 1 | 1 | 1 |
253 | | 1 0 | 1 | 1 | 1 | 1 | 1 | 1 |
254 | 0 | 1 | 1 | 1 | 1 | 1 | 1 | 1 |
255 | 1 | 1 | 1 | 1 | 1 | 1 | 1 | 1 |

10. Start of operation

If the SERVO-TOP has been stored at a temperature of $<+5^{\circ}\text{C}$, then a working temperature of between $+5^{\circ}\text{C}$ and $+40^{\circ}\text{C}$ must first be obtained.
The equipment must be dry.

Before work with the machine can be started, make sure to perform the following:

- a) Control the direction of rotation
- b) Adjust the reference position of the needle bar
- c) Control the needle positions
- d) Control the maximum speed

10.1 Start of the operation with the external operator's control panel OC-TOP

10.1.1 Procedure for checking the direction of rotation and for the correct adjustment of the needle bar (Reference Position NP0)

- a) Activate programming level B (technician level) (see section 9.1.2.2 „programming level B“)
- b) Set parameter 700
- c) Actuate treadle briefly forward:
Reaction: The machine performs a full revolution and then positions in a random position.
- d) Is the direction of rotation correct?
When yes, then proceed to adjust the reference position, proceed with e) below
If no, then activate parameter 800 and change the value $<800>$ (I \rightarrow II or II \rightarrow I) than proceed as b)
- e) Turn the handwheel of the machine in the direction of rotation until the point of the needle coming from up to down touches the level of the throat plate (= reference position).
When doing this it is important that parameter $<701> = \text{I}$.
- f) Actuate the treadle briefly forward:
Reaction: The machine performs one revolution and positions in the same position that had been previously obtained by hand.
- g) As soon as new parameter numbers are activated, or the programming level B is negated, then the parameter value $<700>$ is memorized and the reference position adjustment is completed.

10.1.2 Control of the needle positions (NP1 / NP2 / NP3)

NP1 - needle down position $<702>$
NP2 - thread take up lever in the up position $<703>$
NP3 - needle up $<710>$

- a) Activate programming level B (technician level) (see section 9.1.2.2 „programming level B“)
- b) Activate parameter 702
- c) Actuate the treadle briefly forward
Reaction: The machine performs a revolution and then positions at the programmed $<702>$.
- d) Is the needle position correct?
When yes, then proceed as with g) below.
When no, then the position must be changed by turning the hand wheel (when $<701> = \text{I}$) or via key L+ or L- (when $<701> = \text{II}$)
- e) Actuate the treadle briefly forward
Reaction: The machine performs a revolution and positions in the same position.

- f) The position can again be corrected.
When no further correction is needed, then proceed as with g) below.
- g) As soon as another parameter number is called up, e.g. example 703, the previously programmed value of <702> is memorized.
- h) With parameter 703 and 710 correction is obtained as described above for parameter 702.
- i) Deactivate programming level B (see section 9.1.2.2 „programming level B“).

10.1.3 Control of the positioning (angle) for thread trimming (Parameter 705, 706)

- a) Activate programming level B (technician level) (see section 9.1.2.2 „programming level B“)
- b) Set parameter 705
- c) Actuate the treadle briefly forward
Reaction: The machine performs a revolution and positions at the indicated <705>.
- d) Is the position correct?
When yes, then proceed as g) below.
When no, then the position must be corrected by turning the hand wheel (when <701> = I) or via keys L+ or L- (when <701> = II).
- e) Activate the treadle forward.
Reaction: The machine performs a revolution and positions at the corrected program value <705>.
- f) The position can again be corrected.
If no further correction is needed, then proceed as g) below.
- g) Back heel the treadle.
Reaction: The machine rotates to NP2, <705> is memorized, programming (correction of position) is no longer possible.
- h) If the treadle is back heeled then the thread trim procedure will be activated and the machine performs one revolution.
- i) Should parameter <705> be changed again, then the sequence from c) above must be repeated. In any other event, call up parameter 706 and repeat the sequence from c) above.
- j) Deactivate program level B (see section 9.1.2.2 „programming level B“).

10.1.4 Procedure for checking maximum speed

- a) Activate programming level B (see section 9.1.2.2 "programming level B")
- b) Set to parameter 607
- c) Check the parameter value <607> and make correction if necessary via keys L+ or L-
- d) Deactivate programming level B (see section 9.1.2.2 "programming level B")

10.2 Start of operation using miniature operator's control panel - MOCP (without external operator's panel)

10.2.1 Procedure for checking the direction of rotation and for adjusting the reference position

- a) Set to the code No. for parameter 700 on switches row 1 (front) (01101000) (Fig. 10.1)
- b) Activate the programming mode by pressing key T1 on the MPF
Reaction: H1 and H2 are blinking (condition 6, see section 9.2.3)

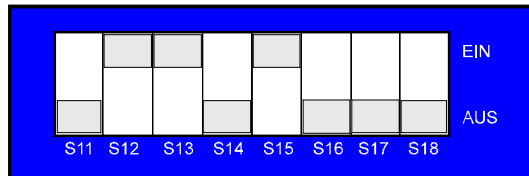

fig.10.1

Code: 0 1 1 0 1 0 0 0

- c) Actuate the treadle briefly forward:
The machine performs a full revolution and then positions in a random position
- d) Was the direction of rotation correct?
If yes, proceed to adjust the zero position, continue with j)
If no, deactivate the programming mode by pressing key T1 briefly
- e) Set to the code number for parameter 800 on switches row 1 (01111000).
- f) Press key T1 again
- g) Use switches row 2 (rear) to set the value (10000000 or 00000000) at which both LEDs light up continuously (condition 5)
- h) Change over the first switch (S21) of row 2 (rear)
- i) Press and hold key T1 for a minimum time of 0.8 seconds, then release; H1 and H2 go dark, but will relight briefly after some delay.
The direction of rotation has been changed, continue with a).
- j) Procedure for adjusting the zero position:
Turn the machine handwheel manually in the direction of rotation until the needle tip, while descending, reaches the level of the needle plate.
- k) Press key T1
Reaction: Both LEDs are blinking at a fast rate; after 0.8 seconds, both are bright continuously.
- l) Release key T1
H1 and H2 go off, but flash up again after a short while.

The zero position of the needle bar has been stored.

10.2.2. Procedure for Checking the Needle Positions (NP1 / NP2 / NP3)

NP1 - needle down <702>

NP2 - thread takeup lever up <703>

NP3 - needle up <710>

- a) Select the code number on selector row 1 (front) for
parameter 702 - 11101000 or
 703 - 00011000 or
 710 - 11011000
- b) Activate programming mode by pressing key T1 on the MPF
Response: The LEDs H1 and H2 are blinking (condition 6, see 9.2.3)
- c) Actuate the treadle briefly forward:
Response: The machine starts running and then positions
Programming (position correction) is possible
- d) Was the needle position correct?
If yes, proceed under g)
If no, correct the position by turning the handwheel
- e) Actuate the treadle briefly forward:
Response: The machine performs a full revolution and then positions in the same position
- f) The position can be corrected again
- g) If no further correction is required, store the position
Press key T1
Response: The two LEDs H1 and H2 are blinking fast; after 0.8 seconds, both stay on
- h) Release key T1
Response: Both LEDs H1 and H2 go off, but flash up again after some time

The selected position has been stored.

10.2.3 Procedure for Checking the (Angular) Position for Thread Trimming (Parameter 705, 706)

- a) Select the code number on selector row 1 (front) for
parameter 705 - 10011000 or
 706 - 01011000
- b) Activate programming mode by pressing key T1 on the MPF
Response: The LEDs H1 and H2 are blinking (condition 6, see 9.2.3)
- c) Actuate the treadle briefly forward:
Response: The machine starts running and then positions according to the values stored for <705>
or <706>
- d) Was the position correct?
If yes, proceed under g)
If no, correct the position by turning the handwheel
- e) Actuate the treadle briefly forward:
Response: The machine performs a full revolution and then positions in the corrected position
- f) The position can be corrected again
If no further correction is required, proceed under g)
- g) Actuate the treadle backward
Response: Machine positions in NP2, position correction is no longer possible

- h) Actuate the treadle backward
Response: Machine performs a full revolution, the thread trimmer mechanism is activated.
This procedure can be repeated various times.
- i) Is further position correction required?
If yes, proceed under c)
If no, deactivate the programming mode by pressing key T1
Response: The two LEDs H1 and H2 are blinking fast; after 0.8 seconds, both stay on.
- j) Release key T1
Response: Both LEDs H1 and H2 go off, but flash up again after some time

The selected position has been stored.

10.2.4 Procedure for Checking Maximum Speed

- a) Select the code number on selector row 1 (front) for parameter 607 - 01001000
- b) Activate programming mode by pressing key T1 on the MPF (see Fig. 10.2)

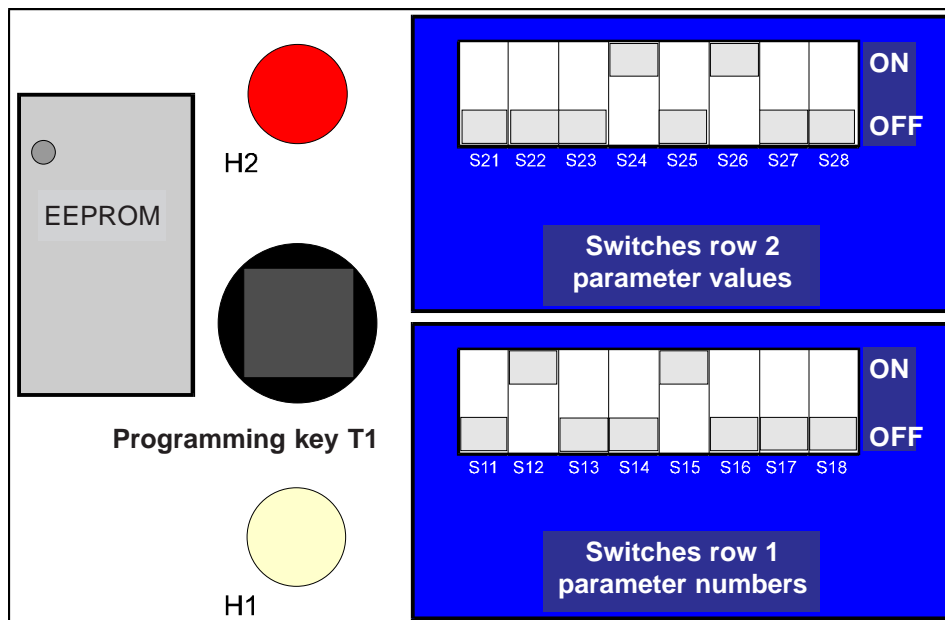

Fig 10.2

- c) Select the parameter value on selector row 2 (rear) - see 9.2.4
- d) If the value stored in the control system coincides with the value selected on selector row 2, H1 and H2 will light continuously (condition 5, see 9.2.3)
- e) If the value selected on selector row 2 is not in agreement with the value stored, this will be shown by H1 and H2 (condition 3 or condition 4, see 9.2.3)
When it is desired to store the value selected on selector row 2, press key T1 longer than 0.8 seconds (see 9.2.4)

10.3 Hardware Test

Hardware Test is a check routine permitting to use the operator panel OC-TOP for testing various components of the drive system (control system) and of the machine installation.

Hardware testing is made via test blocks. These are called up consecutively via key A+ or A-.

Activation of the „hardware test“ routine

- a) Activate programming level „B“ and call up parameter 797
- b) Set <797> to I
- c) Deactivate programming level „B“
- d) Turn mains power switch OFF
- e) Wait for approx. 2 secs. to elapse, and turn mains power switch back ON

Response: The display shows „HARDWARE TEST“ for approx. 2 secs.

After that, the display shows the first test block: Inputs.
All OC-TOP keys equipped with LEDs become bright

Survey of test blocks:

Test Block	Check	Display
1	Inputs	E01 0 X1:5
2	Outputs	A02 0 X2:4
3	Speed control unit	SUG 0
4	Synchronizer	IUG 000 0
5	Potentiometer	R1 XXX%
6	Selectors	WS1-5 00000
7	Miniature Programming Field	MPF H1 0
8	Photocell	LS1 0 LS2 0

To call up the test blocks (advancing from test block to test block), use keys A+ and A-.

To call up various functional elements within a test block (advancing from functional element to functional element), use keys B+ and B-.

To activate functional elements selected, use key D+

Test block 1: Inputs

Display:

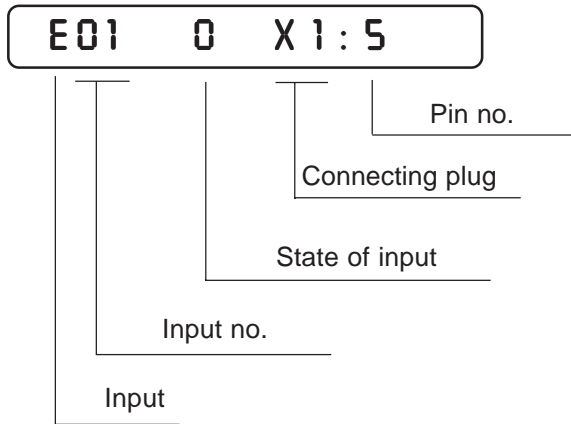

The function assigned to the input displayed can be seen from chapter 12 „Connections Diagram for Connectors“.

The designations E (for input) are located on the lefthand side of the connectors shown. The keys or selectors assigned to the inputs are designated S in the connections diagram and have the same numbers as the associated inputs, i.e.
key S1 is connected to input E1
key S2 is connected to input E2
key Sx is connected to input Ex.

The operating state of the input is signalled in the 7th digit of the display.
Key/switch open → display: 0
Key/switch closed → display: 1

In the righthand part of the display, the connecting plug and the pin number to which the displayed input is connected are shown for the purpose of reference.

Test block 2: Outputs

Display:

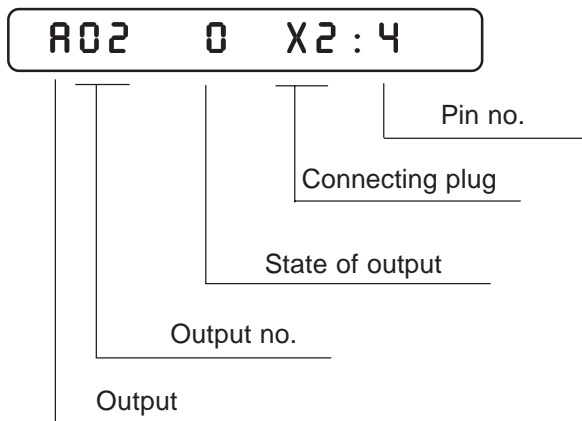

The function assigned to the output displayed can be seen from chapter 12 „Connections Diagram for Connectors“.

The designations A (for output) are located on the lefthand side of the connectors shown.
The solenoids/solenoid valves assigned to the outputs are designated Y in the connections diagram and have the same numbers as the associated outputs, i.e.
solenoid Y2 is connected to output A2
solenoid Y3 is connected to output A3
solenoid Yx is connected to output Ax

The operating state of the output displayed is signalled in the 7th digit of the display.
Output not activated → display: 0
Output activated → display: 1

To activate an output, use key D+. Deactivation is made automatically after approx. 2.5 secs have elapsed or can be caused by using key D-.

In the righthand part of the display, the connecting plug and the pin number to which the displayed output is connected are shown for the purpose of reference.

Test block 3: Speed control unit (SWG)

Display:

A rectangular digital display with a black border. The text 'SWG 0' is shown in a bold, black, monospace font. 'SWG' occupies the first three digits, and '0' occupies the fourth digit.

The treadle can be actuated to operate consecutively all 16 steps of the speed control unit.

The following is displayed in digits 6, 7 and 8

-2 / -1 / 0 / +1 / 10 / 20 / ... / 120, when the speed control unit is in proper condition.

Test block 4: Synchronizer (IWG)

Display:

A rectangular digital display with a black border. The text 'IWG 000 0' is shown in a bold, black, monospace font. 'IWG' occupies the first three digits, '000' occupies the next three digits, and '0' occupies the final digit.

This test block permits to check the synchronizer (position control unit). For this purpose, the shaft accommodating the synchronizer is rotated manually.

The synchronization track is signalled in digit 11 of the display. At the first change of the display in digit 11, from 0 to 1, the increments (pulses) of the synchronizer are counted and shown in display digits 7, 8 and 9.

This display runs from 0 through 239 when the synchronizer is in proper condition.

Test block 5: Potentiometer R1

Display

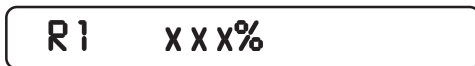
A rectangular digital display with a black border. The text 'R1 xxx%' is shown in a bold, black, monospace font. 'R1' occupies the first two digits, 'xxx' occupies the next three digits, and '%' occupies the final digit.

This test block permits to check potentiometer R1 on the control box.

The display is in a proportion (%) of total resistance.

Turning the potentiometer axle causes the display to vary from 0 through 100.

Test block 6: Selectors

Display





A rectangular digital display with a black border. The text 'WS1-5 00000' is shown in a bold, black, monospace font. 'WS1-5' occupies the first five digits, and '00000' occupies the next five digits.

This test block permits to check the 5 selectors (WS1 ... WS5) on the control box. The operating state is shown in digits 8 to 12 of the display. Each switch has a display digit assigned to it.

The operating state is signalled by 0 and 1 for WS1, WS2 and WS3 and by 0, 1 and 2 for WS4 and WS5.

Test block 7: Miniature Programming Field (MPF)

Display:

- a) 
- b) 
- c) 
- d) 
- e) 

This test block permits to check the components of the miniature programming field (MPF). To advance from display to display (a) → b) → c) ...) use key B+ or B-.

- a) LED H1
activate via key D+, H1 being bright; digit 8 in display shows 1
- b) LED H2
activate via key D+, H2 being bright; digit 8 in display shows 1
- c) Switch row 1 (SR1)
Changing over the switches alters the display (0/1). Each switch has a display digit (9 ... 15) assigned to it.
Only switches 1 ... 7 are shown, switch 8 has no function.
- d) Switch row 2 (SR2)
Changing over the switches alters the display (0/1). Each switch has a display digit (9 ... 16) assigned to it.
- e) Key T1
The operating state of the key is shown in display digit 8.

Test block 8: Photocell

Display:

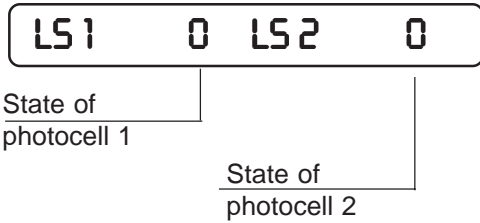

State of display 0: photocell is clear
 1: photocell is dark

To deactivate the test routine, turn the mains power switch OFF.