

Instruction Manual

MODEL MK-70



www.PromElectroAvtomat.ru

CONTENTS

SETTING UP THE MACHINE	1
PRECAUTIONS	3
REPACKING THE MACHINE	4
NAME OF OPERATIONAL PARTS.....	6
ACCESSORIES	7
YARN PREPARATION	8
THREADING THE AUTO TENSION.....	9
STITCH DIAL AND STITCH SIZE	10
CAM LEVER AND STITCH TYPES	11
NEEDLE BED AND NEEDLES	12
Latch Needle	12
Needle Positions.....	12
How a stitch is formed on the needle.....	12
CAST ON.....	13
Stripe Pattern.....	16
Removing the Fabric	17
BASIC TECHNIQUES.....	18
Mock Rib.....	18
Decrease and Increase of single stitch.....	20
Decrease and Increase of multiple stitches	21
Cast off	22
Pressing the mock rib	22
GETTING TO KNOW ABOUT PATTERN KNITTING	23
Operation Table.....	23
Punch Card	23
Setting Punch Card	24
Punch Card and Pattern Positions.....	25
A Card for various stitch types.....	25
For success in pattern knitting	25
KNIT-IN (FAIR ISLE).....	26
SLIP STITCH	27
TUCK STITCH	28
TUCK/SLIP STITCH IN COLOURS.....	29
CORD KNITTING.....	30

CONTENTS

TAKING A TENSION GAUGE.....	31
Gauge Scale.....	31
Tension Swatch.....	31
Knitting a Tension Swatch.....	32
How to measure the tension swatch.....	33
KNITTING TECHNIQUES.....	34
Fully Fashioned Decrease.....	34
Fully Fashioned Increase.....	34
Partial Knitting by decreasing stitches.....	35
Partial Knitting by increasing stitches.....	36
Holding stitches in D position.....	37
Holding stitches on waste knitting.....	37
Holding stitches with Ravel Cord.....	38
Hemming.....	39
Picot Edge.....	39
Trimming.....	40
Buttonhole.....	41
Joining on the machine.....	42
Blind Stitch.....	43
Slip Stitch.....	43
Grafting.....	43
K1. P1. Rib.....	44
Cable Stitch.....	45
Garter Stitch.....	45
LADY'S PULLOVER.....	46
WHAT TO DO IF.....	50
INDEX.....	60

SETTING UP THE MACHINE

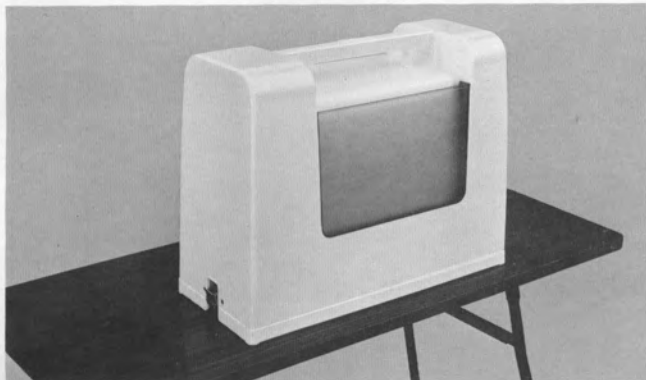

1. Place the machine on the table with its transparent book pocket facing you.

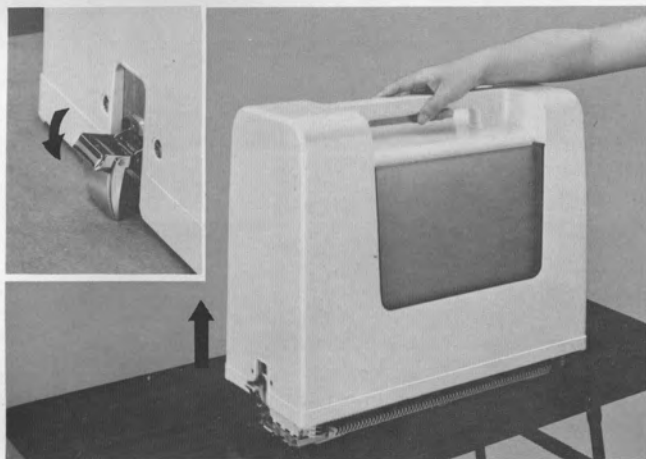

2. Unlock the latch on both sides of the case cover, and lift it up.

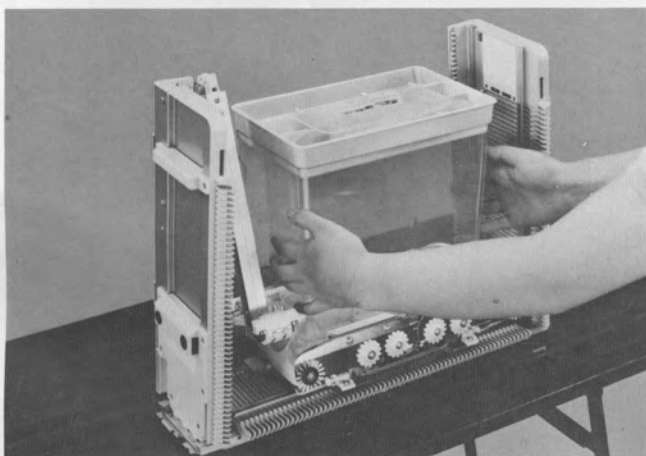

3. Lift up the transparent box.

Use the transparent box for many purposes such as to keep the yarn balls.

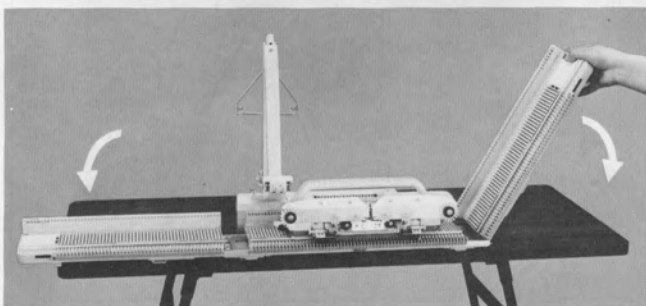

4. Hold the ends of the needle bed and gently lay down flat on the table.

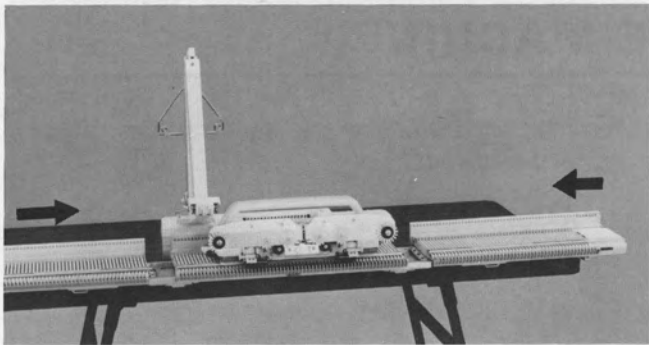

5. Push in both ends of the needle bed till they lock in position with a clicking sound.

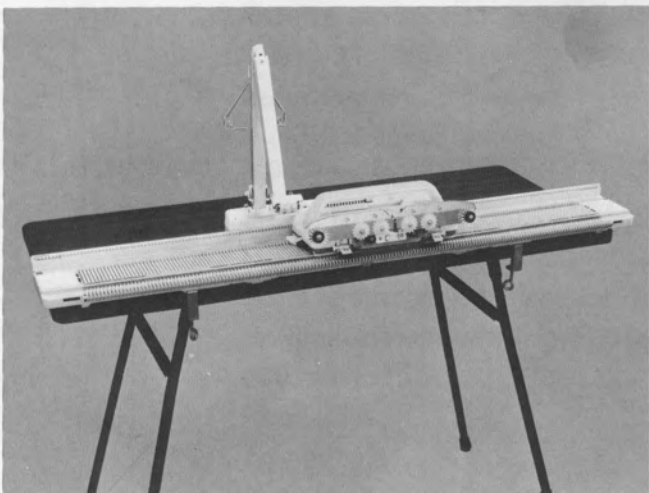

6. Take out two Clamps from the accessory box, and fix the machine as shown on the table.

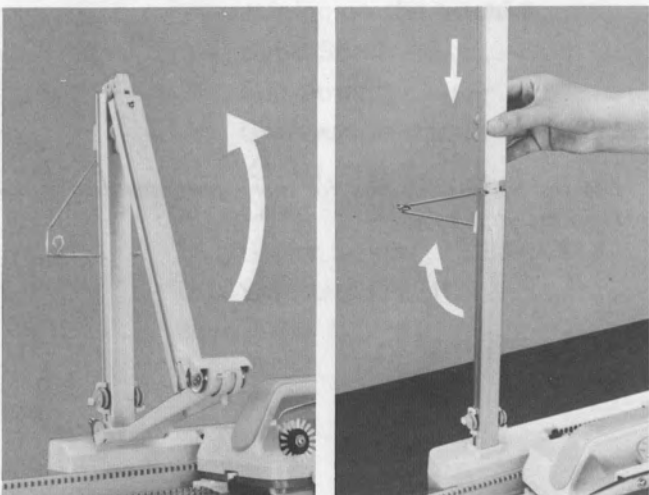
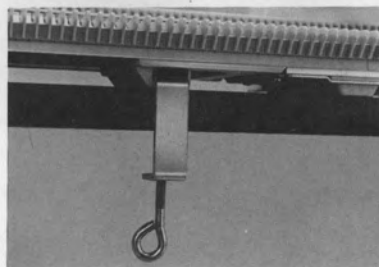

7. Stretch the Tension Post straight, and push in till it locks in position.
DO NOT APPLY TOO MUCH FORCE.

8. Raise the Yarn Guide till it locks in position.

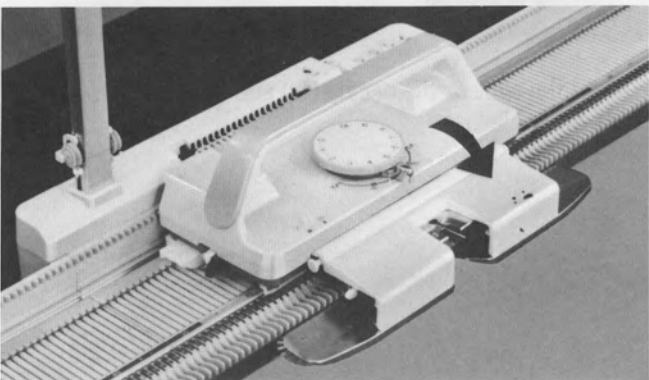

9. Turn round the Arm to the locking position.

PRECAUTIONS

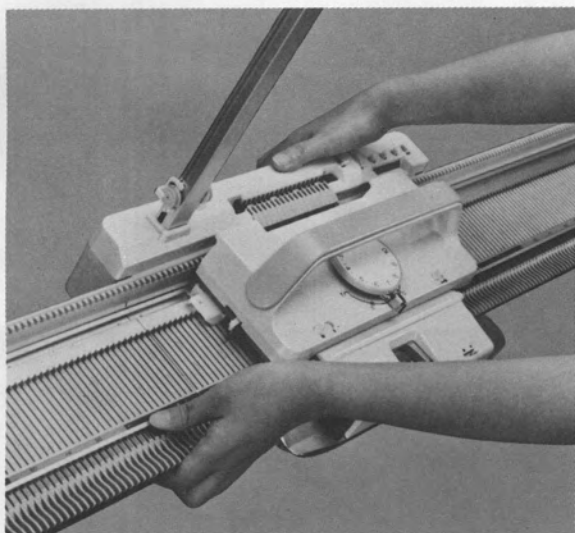

If you carry the machine as it is opened, hold centre portion of the needle bed.

DO NOT HOLD THE ENDS OF THE NEEDLE BED

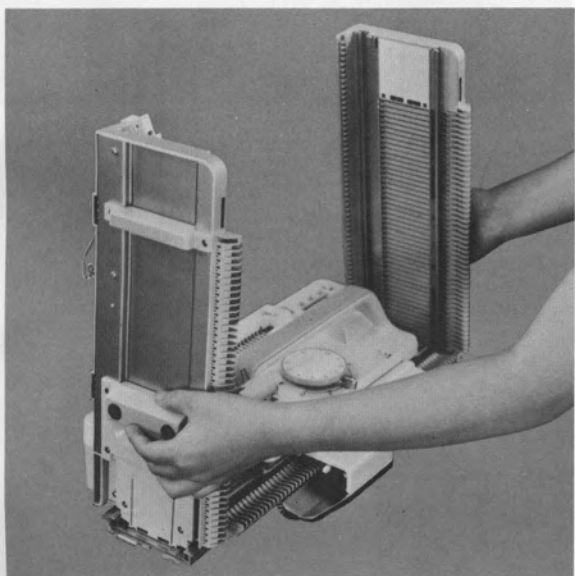

If you carry the machine as it is folded, hold the Clamp receivers as shown.

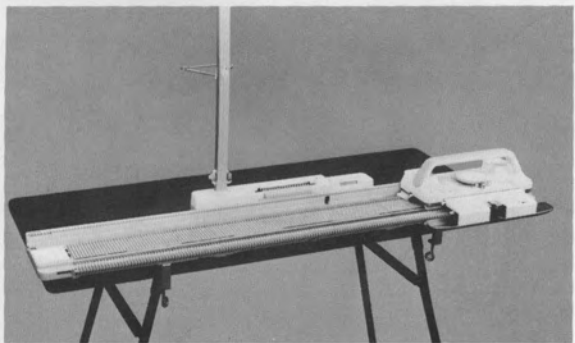

To use the machine, secure it with Clamps on the table.

REPACKING THE MACHINE

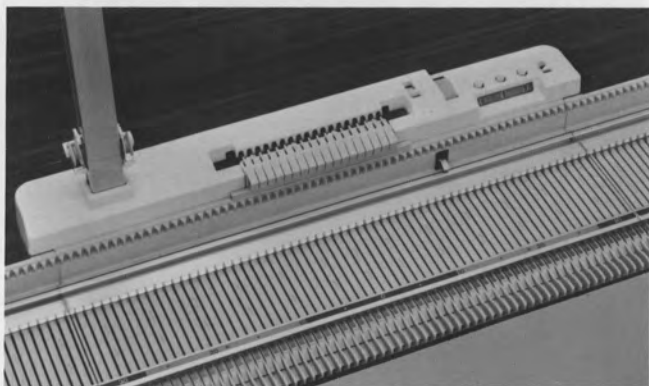

Refer to this and next pages only when you repack the machine.

1. Align all the needles correctly in "A" position, using the Needle Pusher.

Remove the yarn from the Auto-Tension before repacking the machine.



2. Pull the Arm Lever at both sides of the Arm towards you and lift up the Arm till it gives out clicking sound.

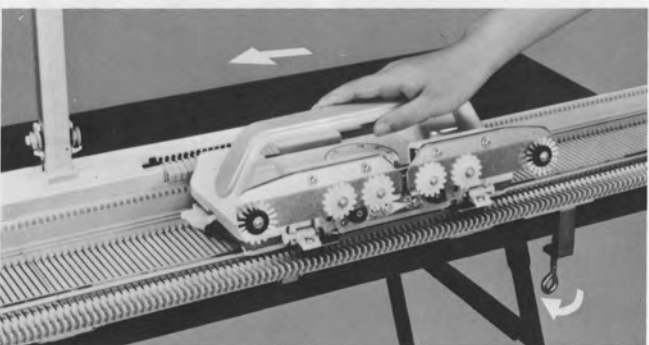

3. Bring the Carriage to the centre of the needle bed.

4. Remove both Clamps.

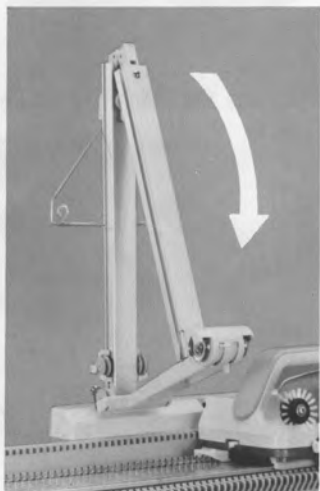
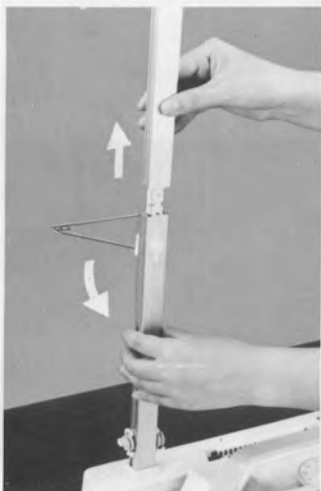

5. Fold down the Yarn Guide.

6. Pull up the upper part of the Tension Post to separate at its centre, and fold it towards you.

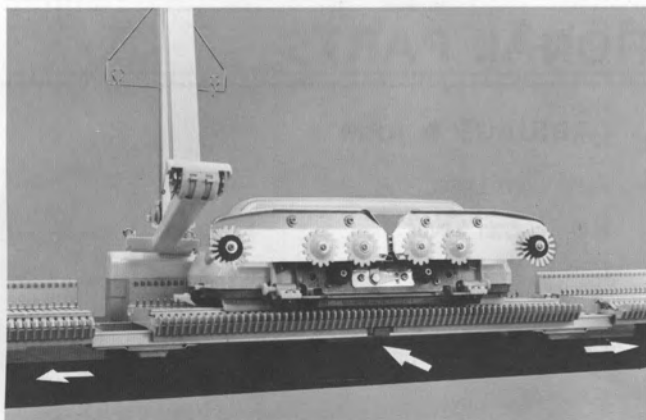

7. Press the Red Button (Lock Lever Button) at the front bottom edge of the needle bed.

Pull out both ends of the needle bed as far as they come out.

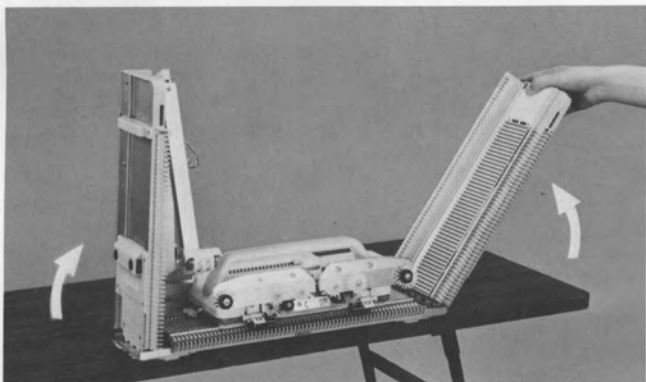

8. Fold up both ends of the needle bed till they stop in locked position.

DO NOT FOLD UP THE NEEDLE BED UNTIL BOTH ENDS COME OUT COMPLETELY.

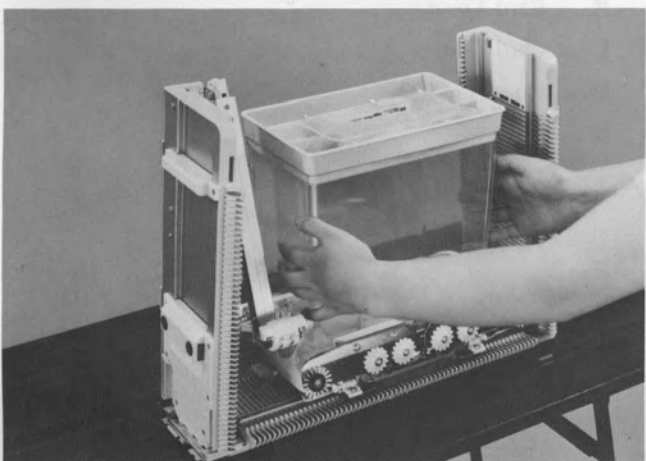

9. Replace the utility box to the original position, and place the case cover over it.

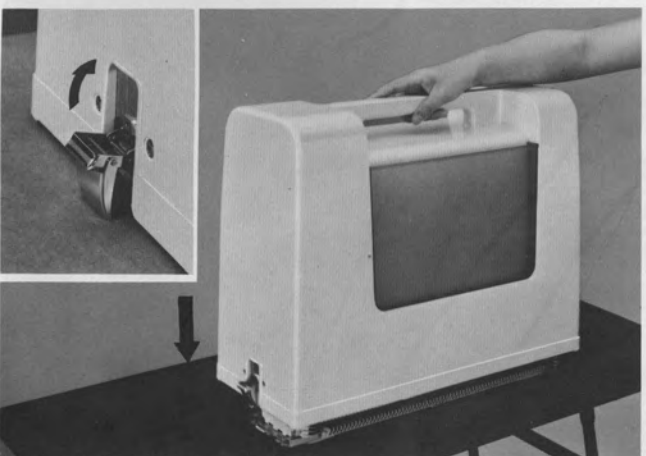

10. Lock the latch at both sides of Case Cover.

MAKE SURE THE LATCHES ARE SECURELY LOCKED BEFORE HOLDING UP THE MACHINE.

NAME OF OPERATIONAL PARTS

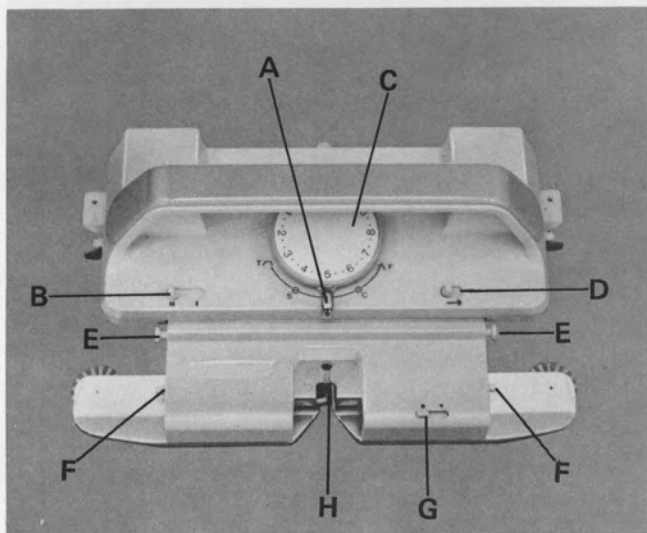

✓ CARRIAGE & ARM

- A – Cam Lever
- B – Russel Lever
- C – Stitch Dial
- D – Release Lever
- E – Arm Coupling Pin
- F – Arm Lever
- G – Cast-on Lever
- H – Yarn Feeder

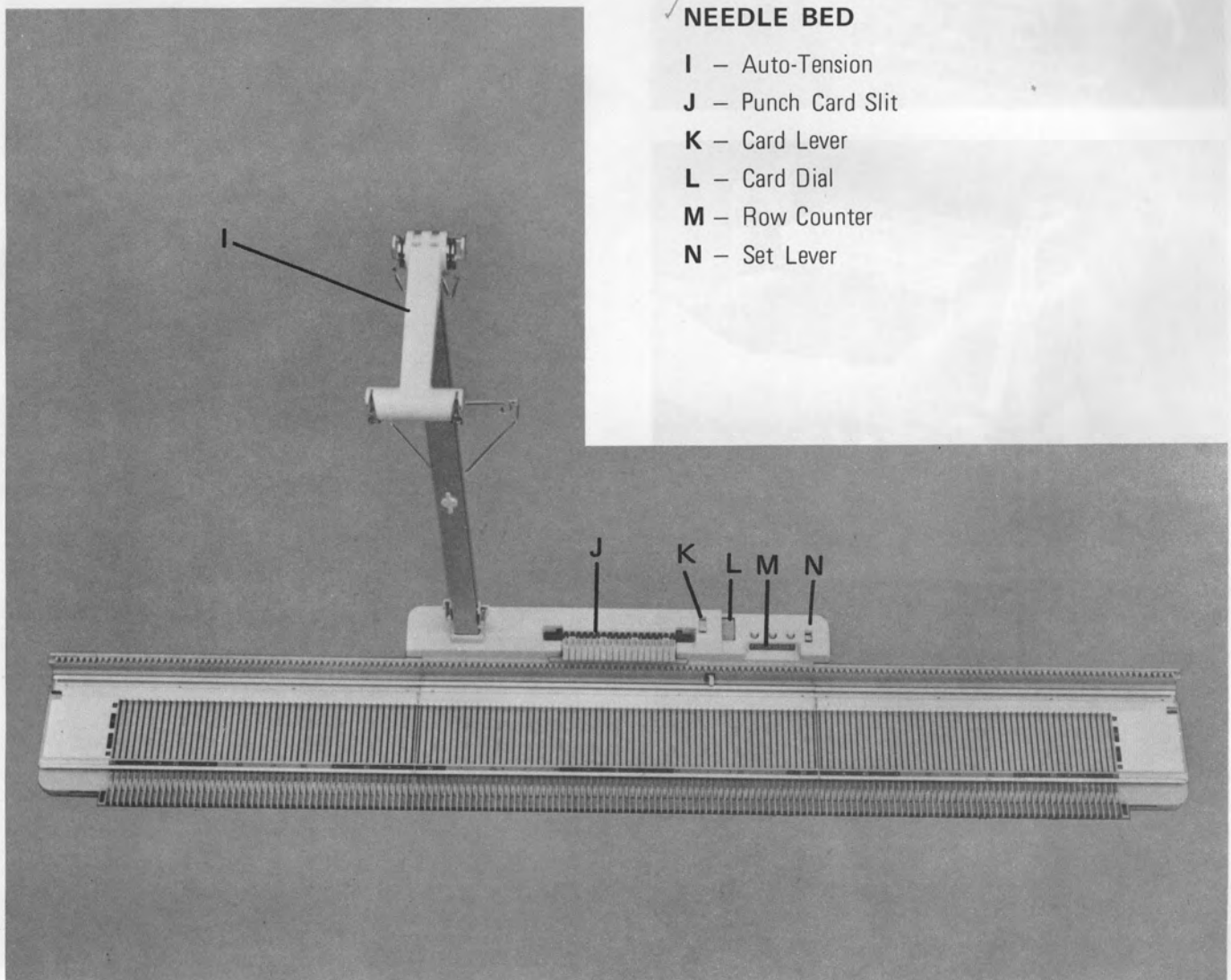

✓ NEEDLE BED

- I – Auto-Tension
- J – Punch Card Slit
- K – Card Lever
- L – Card Dial
- M – Row Counter
- N – Set Lever

ACCESSORIES

- A - Clamp (2)
- B - Claw Weight (2)
- C - Ravel Cord (2)
- D - Tapestry Needle
- E - Gauge Scale
- F - Needle Pusher 1/1, 2/1
- G - Transfer Tool 1-2, 2-3
- H - Tappet Tool
- I - Crochet Hook
- J - Punch Card (5)
- K - Card Snap (4)
- L - Yarn Rest (2)
- M - Spare Needle (3)
- N - Cleaning Brush
- O - Oil

(Numbers in brackets refer to quantity.)

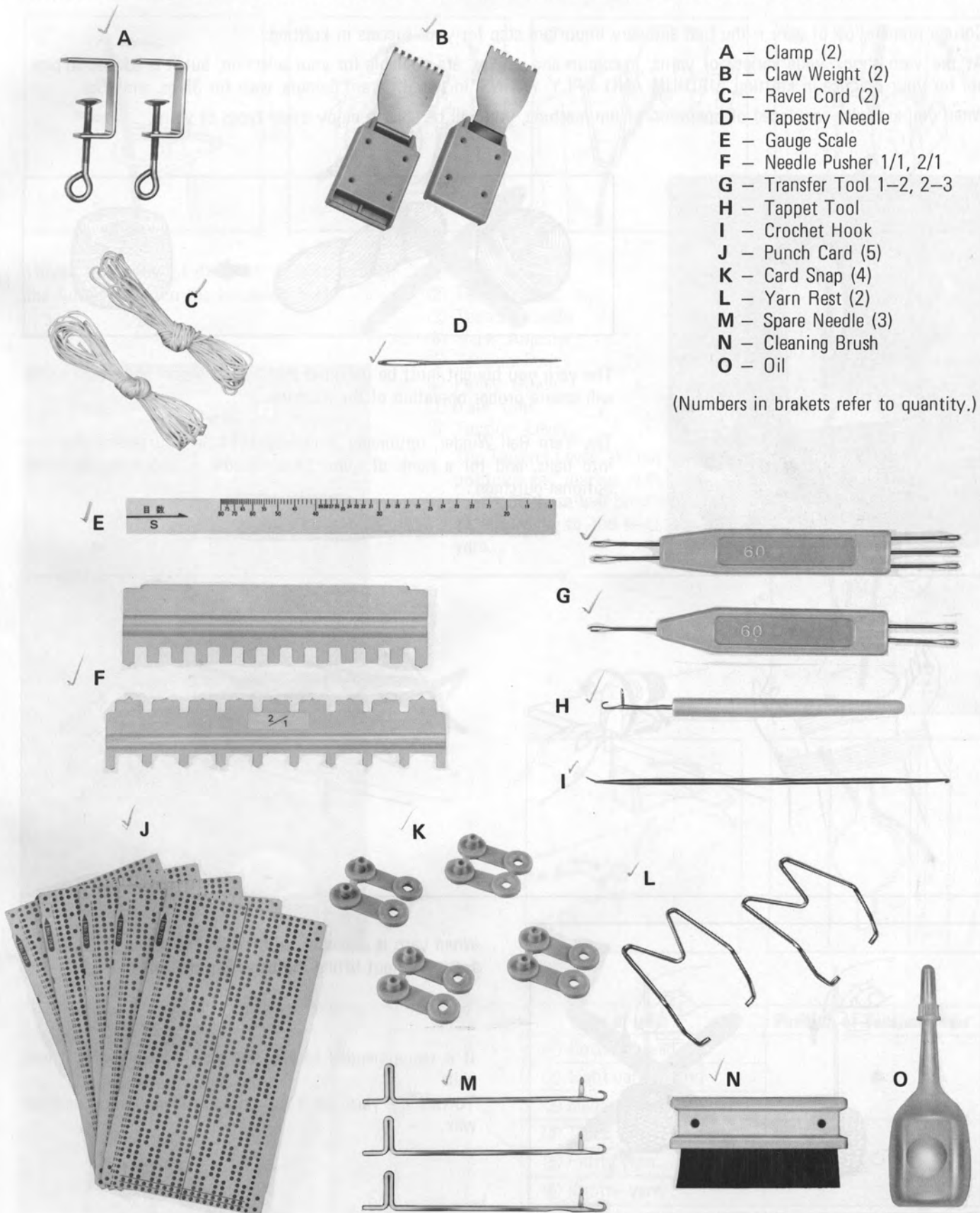

YARN PREPARATION

Correct preparation of yarn is the first and very important step for your success in knitting.

At the yarn shops, wide variety of yarns, in colours and quality, are available for your selection, but it is advised to pick up, for your practice in knitting, MEDIUM AND 4-PLY YARNS, in two different colours, each for 35 gs. and 15gs.

When you are fully convinced of operation of the machine, you will be able to enjoy other types of yarns.

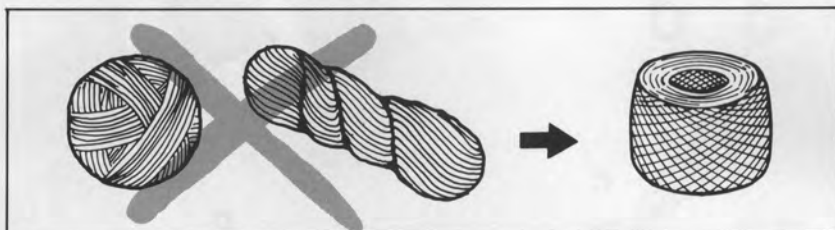

The yarn you bought must be rewound into balls as shown above, since they will ensure proper operation of the machine.

The Yarn Ball Winder, optionally available, will help you rewind the yarn into balls, and for a hank of yarn, Skein Holder is also available for an optional purchase.

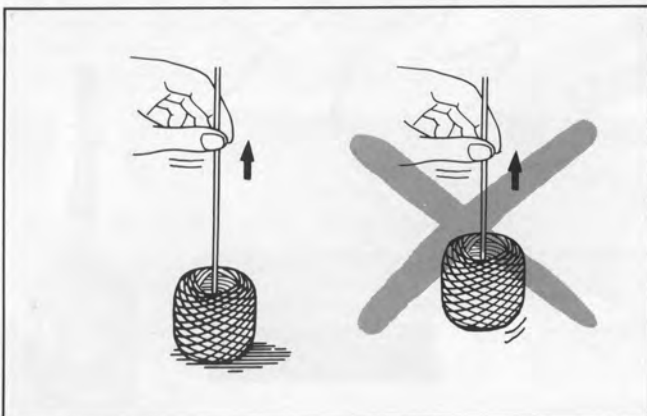
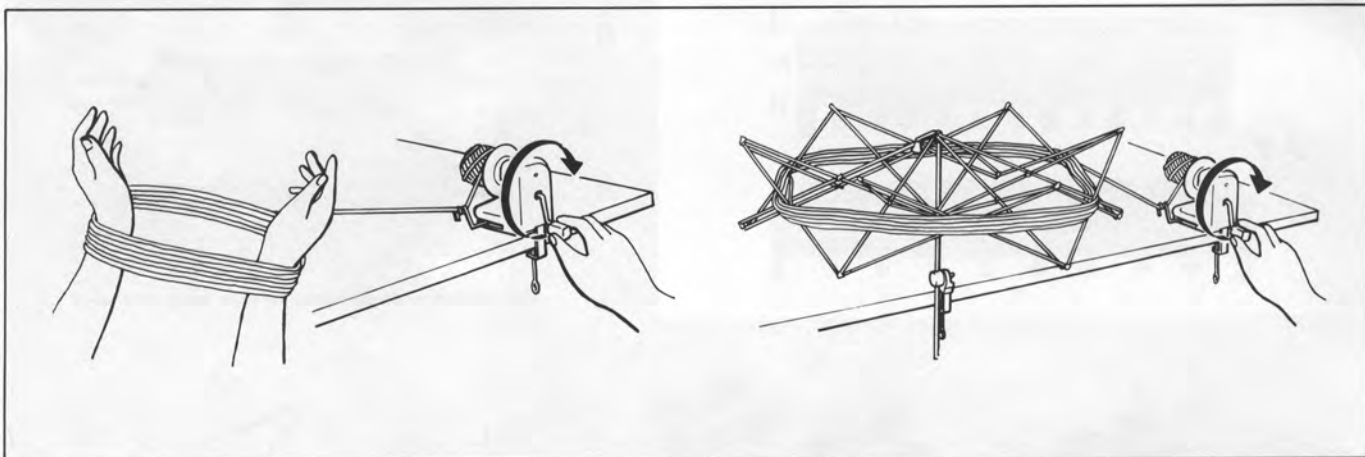

When yarn is rewound, ensure that the yarn end comes out freely without lifting the ball from the table.

It is recommended to wax the yarn when winding it into balls.
To wax the yarn, let it run on an ordinary white candle or wax.

THREADING THE AUTO-TENSION

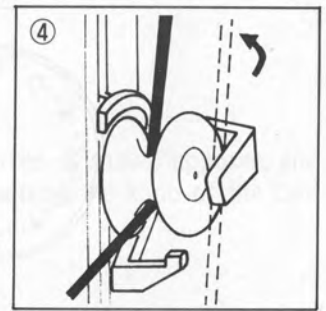
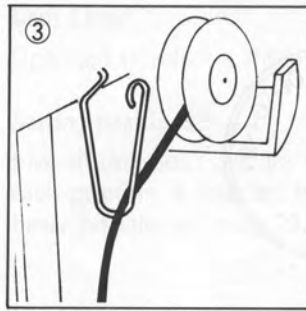
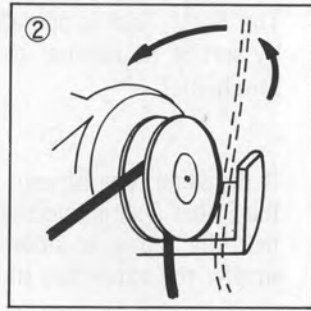
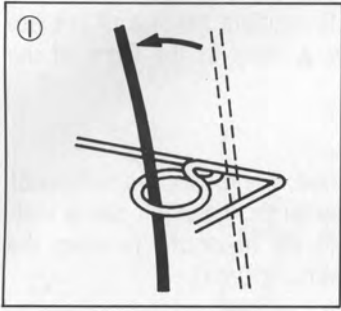

Thread two yarns of different colours through the Auto-Tension in the following order.

- ① Yarn Guide
- ② Tension Disc
- ③ Tension Guide
- ④ Slack Adjuster
- ⑤ Tension Pulley
- ⑥ Pulley Guide
- ⑦ Yarn Clip
- ⑧ Tension Lever

The Tension Lever "A" has two setting positions and marked with ○ and ●. Either of those two positions is selected according to the thickness of the yarn.

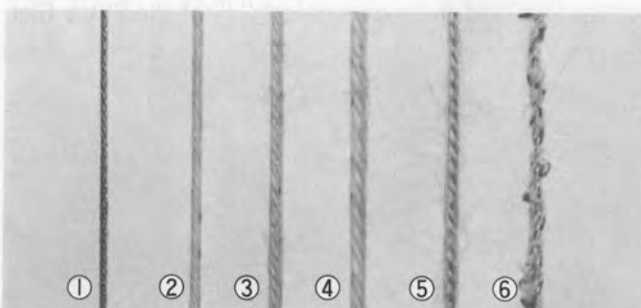
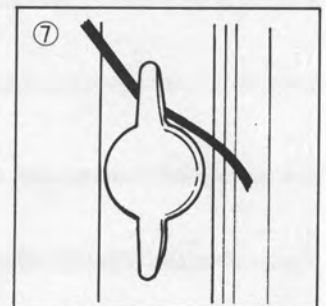
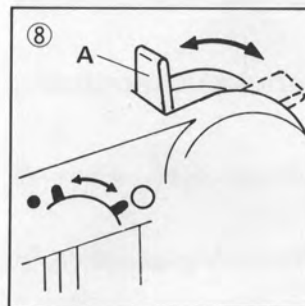
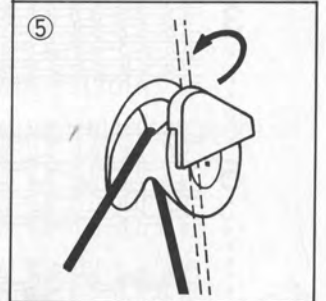
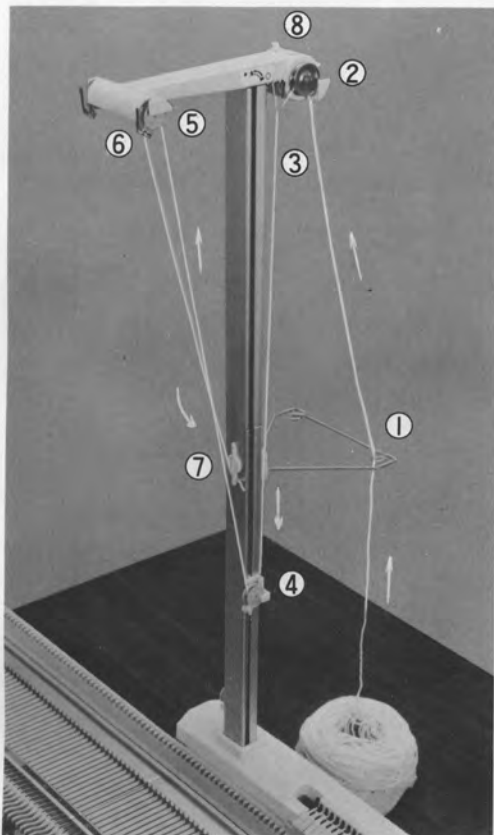

Type of yarn	Position of Tension Lever
① Cotton thread	●
② Light yarn (3-ply)	
③ Medium yarn (4-ply)	
④ Thick yarn	○
⑤ Fluffy yarn	
⑥ Knotty yarn	

STITCH DIAL AND STITCH SIZE

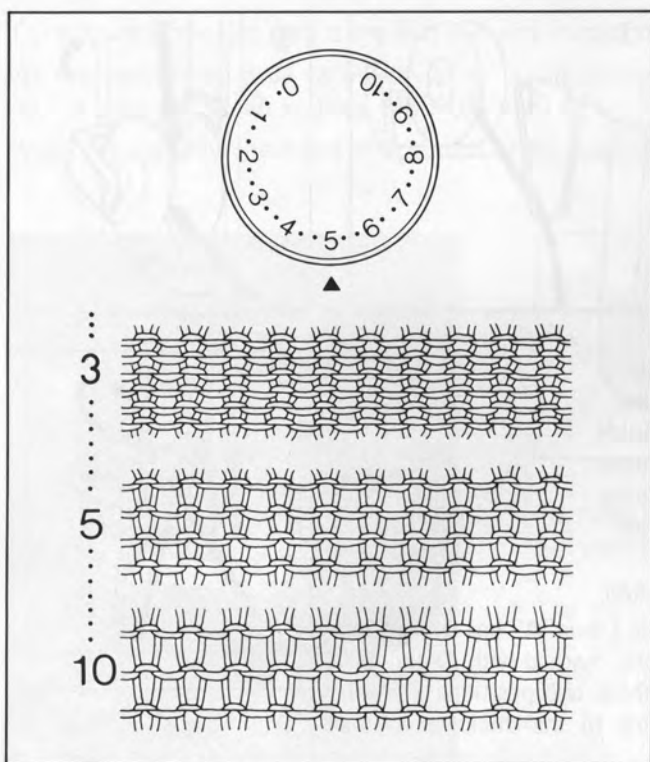

The Stitch Dial is operated to regulate the size of stitches by setting its number to the ▲ mark at the front of the Stitch Dial.

If the same type of yarn is used, the higher the number of the Stitch Dial is selected, the larger the stitch size is knitted (the fabric is loose), and the lower the number, the smaller the stitch size (the fabric is tight).

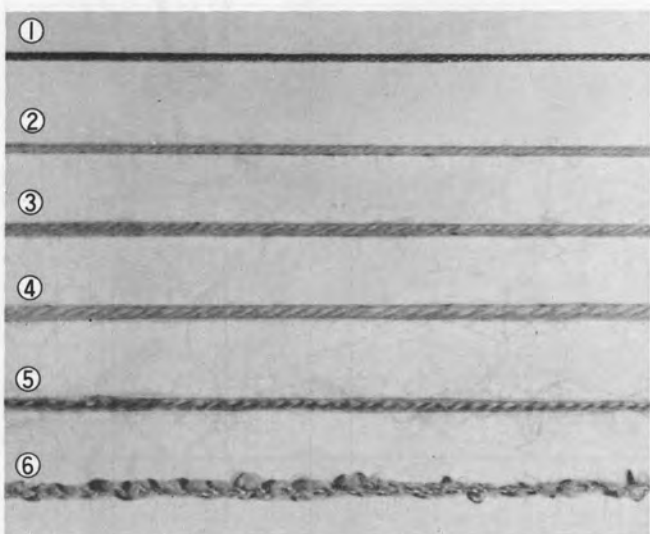

To obtain suitable stitch size, or suitable tension for a garment, change the setting of the Stitch Dial Number according to the thickness of the yarn, referring to the photograph of yarns in actual size and the table opposite.

The thicker the yarn, the higher the Stitch Dial Number must be selected, and the thinner the yarn, the lower the Stitch Dial Number.

Type of yarn	Stitch Dial
① Cotton thread	2 – 3
② Light yarn (3-ply)	3 – 4
③ Medium yarn (4-ply)	6 – 7
④ Thick yarn	9 – 10
⑤ Fluffy yarn	8 – 10
⑥ Knotty yarn	8 – 10

For medium and 4-ply yarn, select "7" of the Stitch Dial Number.

CAM LEVER AND STITCH TYPES

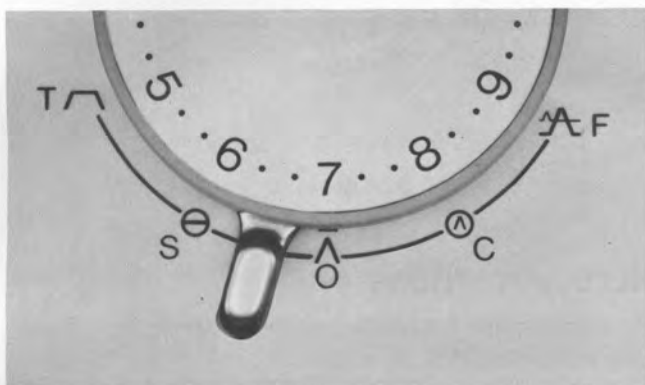

Cam Lever

Operated to select a stitch type.

Setting positions

Five setting positions are marked as shown opposite, and each position is selected by setting the knob of the Cam Lever on selected mark.

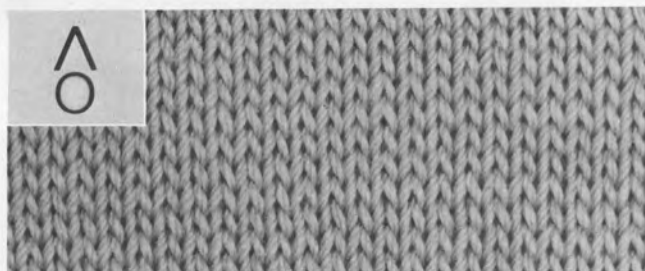

$\Lambda(O)$STOCKINET (PALIN STITCH)

Knits only stockinet (plain stitch) and no punch card is used.

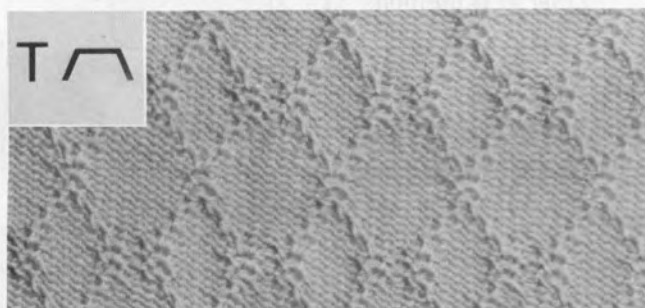

$\wedge(T)$TUCK

Punch Card must be used together.



$\ominus(S)$SLIP

Punch Card must be used together.



$\wedge(F)$KNIT-IN (FAIR ISLE)

Use more than two colours and a Punch Card.

$\odot(C)$CORD

very usefull for knitting a cord.

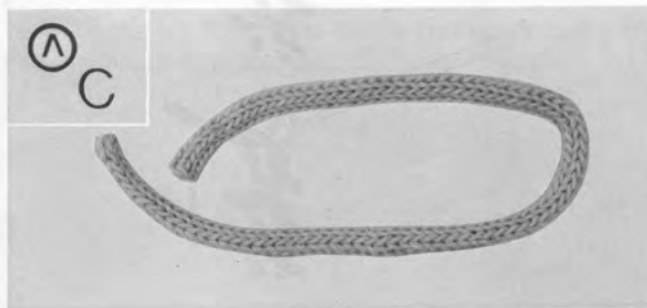

NEEDLE BED AND NEEDLES

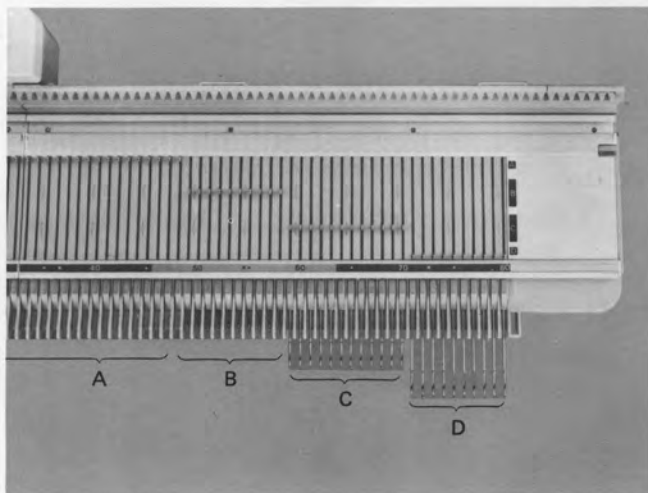
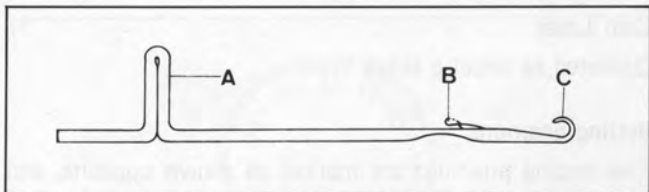

LATCH NEEDLE

On the Needle Bed, 160 needles are given. Each needle has following functional parts.
A – butt B – latch C – hook

NEEDLE POSITIONS

On both ends of the needle bed, the letter A, B, C, D, are marked on the black background which denotes the needle aligning ranges.

- A.....non-working position
- B.....knitting position: needles knit according to the Cam Lever settings.
- C.....knitting position: needle knit only stockinet stitch and align in B position.
- D.....holding position: needles remain in this position holding stitches with Russel Lever I, or the needles knit stockinet stitch and back to B position with Russel Lever at II position.

How a stitch is formed on the needle.

- ① As the Carriage moves, the needle is pushed forward, and the latch is opened by its stitch.
- ② New yarn is fed into the hook.
- ③ The needle is pulled backward, and its latch is closed confining the yarn in the hook.
- ④ As the needle moves further backward, the old stitch drop off of the needle interlooping with the new yarn, and a new stitch is formed on the needle.

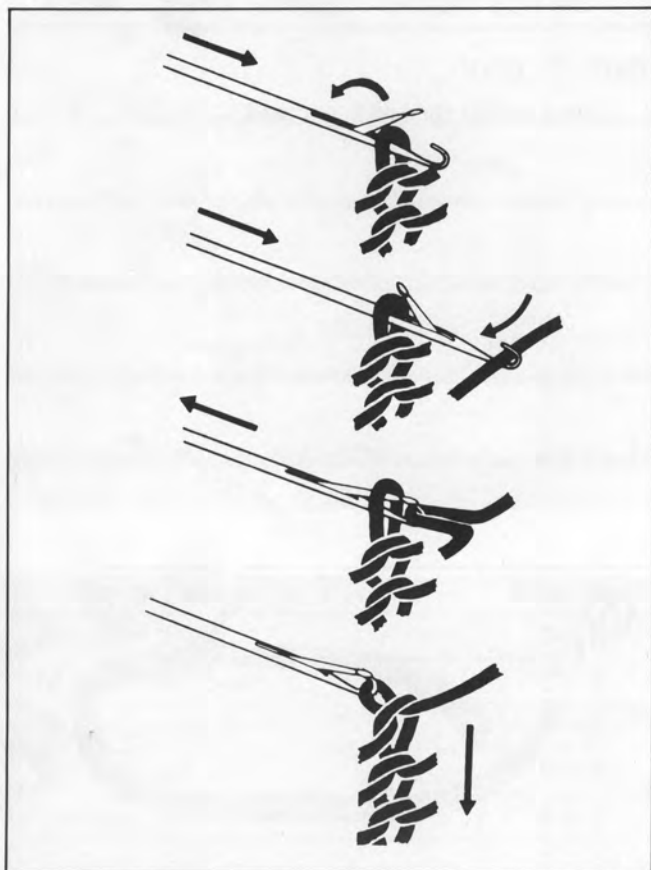

CAST ON

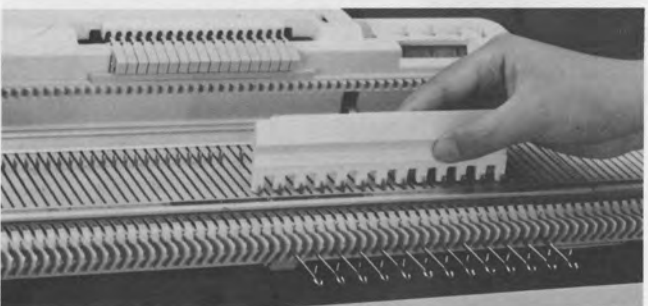
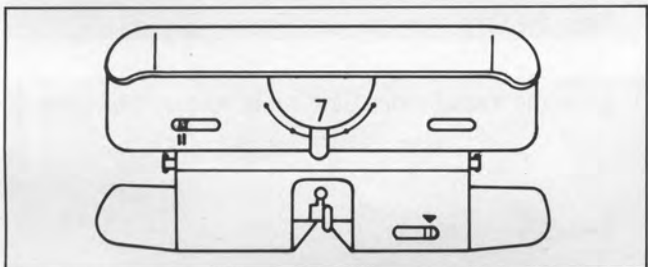
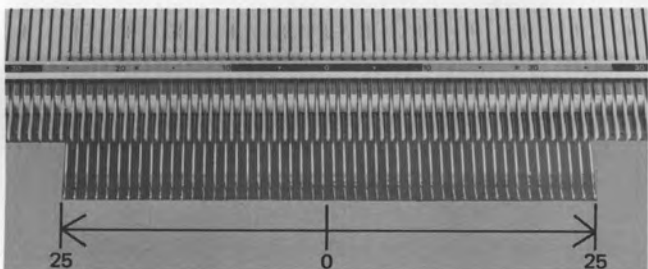

1. Arrange 25 needles on both sides of the centre(0) in D position in the following manner.

Place the straight edge of the Needle Pusher obliquely on the Needle Bed with the cut edge at the corner of the Pusher placed behind the needle butts.

Slide the Pusher as placed obliquely, and the needles will be pushed forward to D position along the straight edge of the Pusher.

2. Set the Carriage as follows:—

Cam Lever.....	▲
Stitch Dial.....	7
Russel Lever.....	II
Cast-on Lever.....	▼

3. Move the Carriage slowly across the needles and leave it at the left side off the needles.

The needles are aligned in B position.

4. Set the Row Counter in motion by setting its Set Lever to ▼ position.

Adjust the numbers to

5. Using the 1/1 edge of the Needle Pusher, push up every other needle to D position.

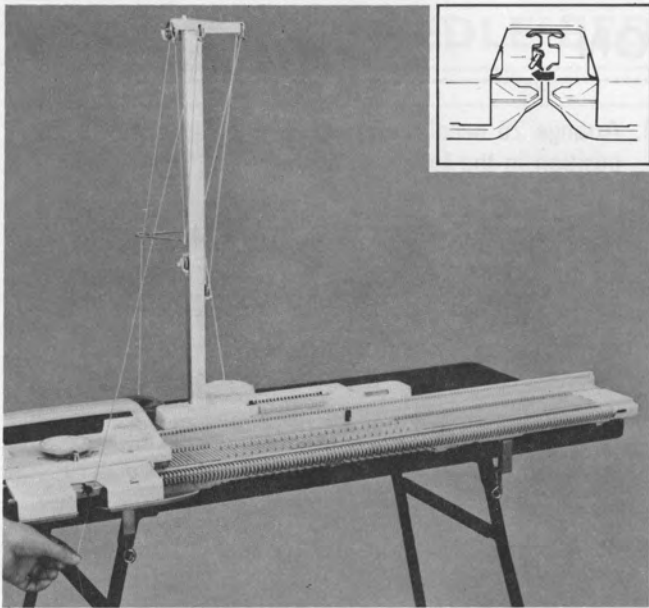

6. Release either of the yarns from the Clip on the Tension Post.

Bring it to the Yarn Feeder on the Carriage Arm.

7. Open the Yarn Feeder Gate.

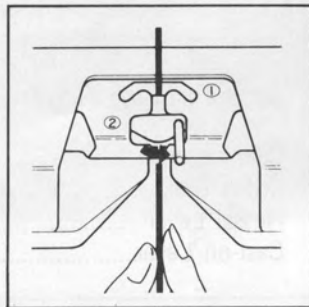
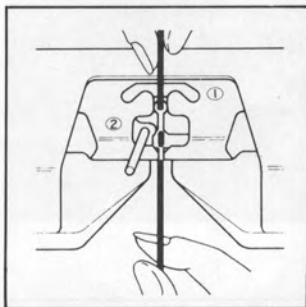

8. Hold the yarn with both hands, at above the Yarn Feeder, and below the Yarn Feeder.

Place the yarn into the Yarn Feeder ①.

9. Close the Yarn Feeder Gate while holding the yarn end.

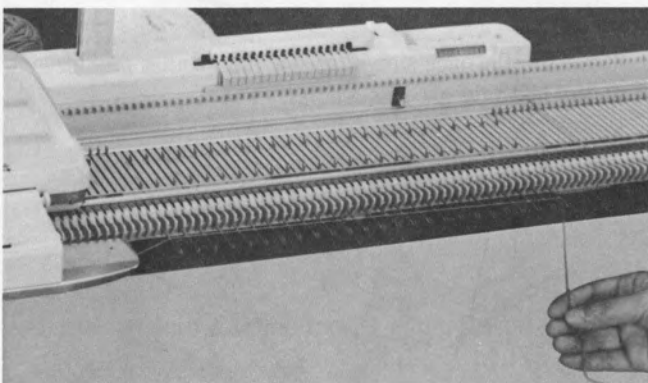

10. Lay the yarn over the needles in D position.

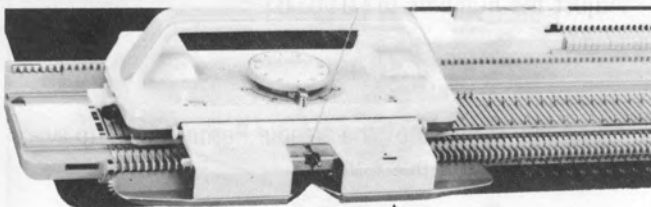

Check the bottom of the Fabric Presser to see that the yarn runs without entanglement as shown.

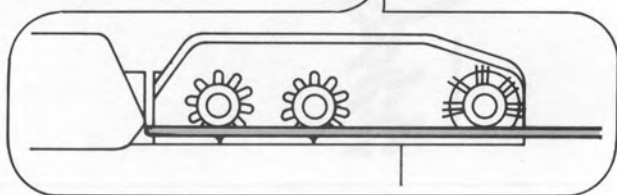

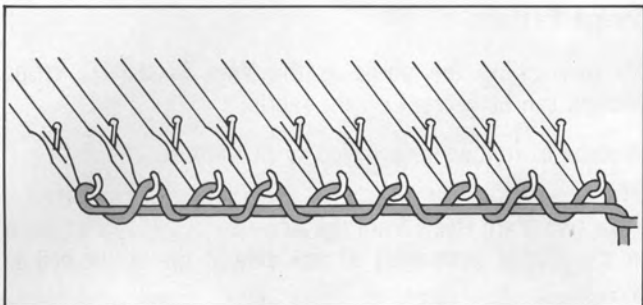

11. Move the Carriage towards the right end of the needle bed till it passes by the end knitting needle.

The first row (cast-on row) is knitted as shown opposite.

If you have failed in this step, repeat from the beginning.

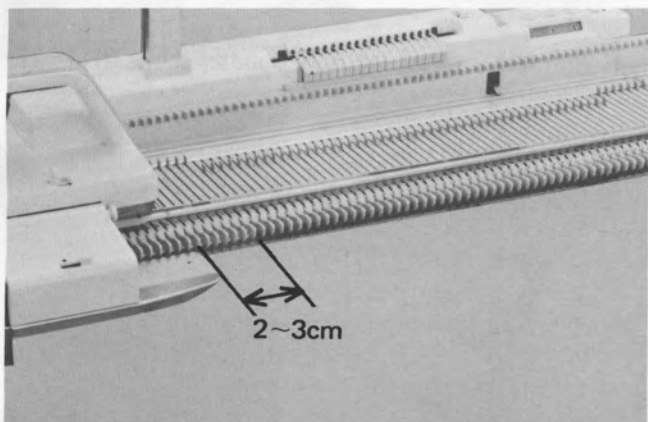

12. Return the Carriage towards the left end of the needle bed.

Knit continuously 6 rows, moving the Carriage back and forth over the needles.

Be sure to pass the Carriage over the end knitting needle by about 2-3cm. on every row.

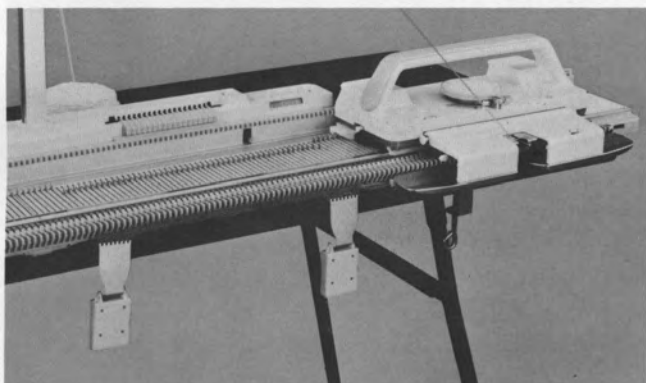

12. Set the Cast-on Lever to ● mark.

13. Hang the Claw Weights at both ends of the fabric.

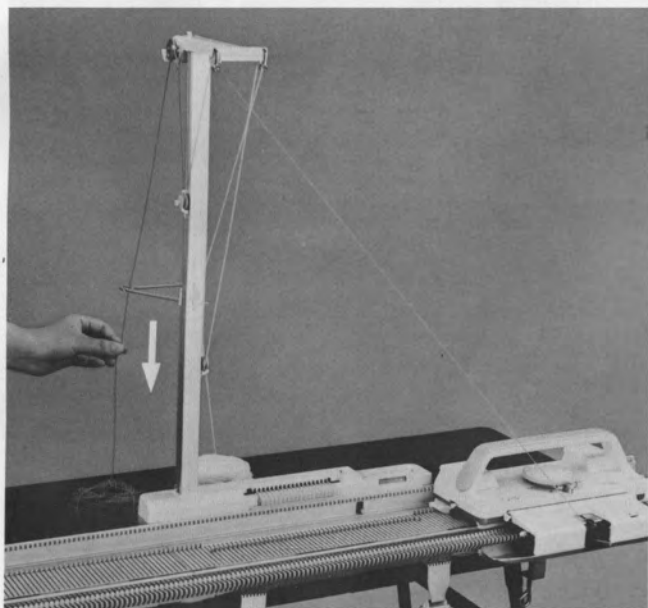

14. Pull the yarn toward the yarn ball at the back of the Tension Post, so as to take up the slack on the yarn, then knit continuously.

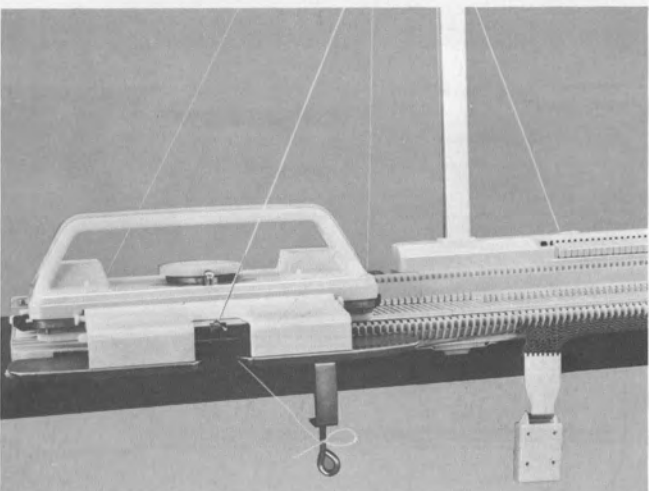
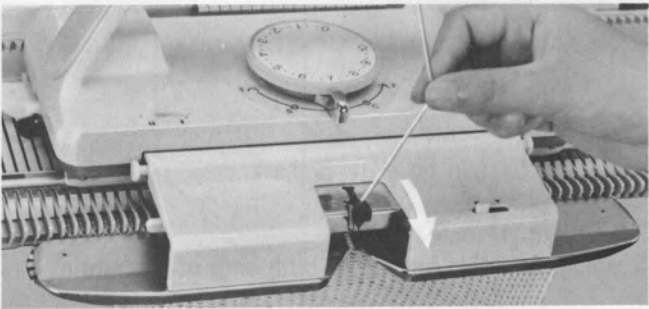
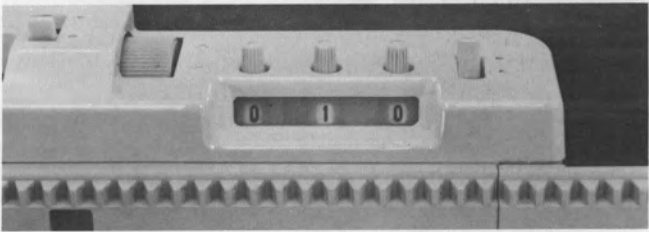
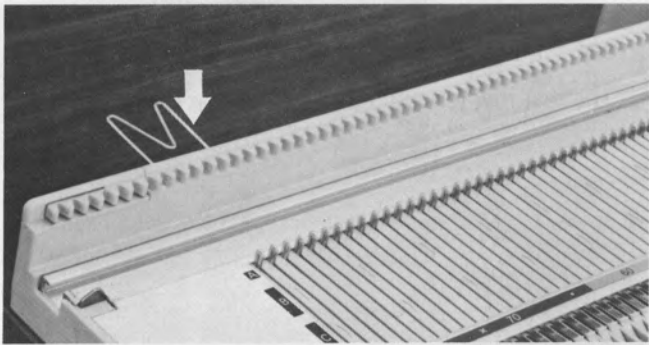

Stripe Pattern

By exchanging the yarns in the Yarn Feeder ①, stripe pattern can be knitted on the fabric.

Proceed as follows to practice stripe pattern.

Take two Yarn Rests from the Accessory Box, and fit them in the slot at both ends of rear side of the needle bed as shown.

Knit with one yarn till the Row Counter shows

0	1	0
---	---	---

Open the Yarn Feeder and remove the yarn from it.

Guide the removed yarn under the needle bed, to the Yarn Rest at the back of the needle bed as shown.

Take the other yarn from the Clip on the Tension Post, and place it in the Yarn Feeder ①.

Fasten the yarn end at the Clamp screw grip.

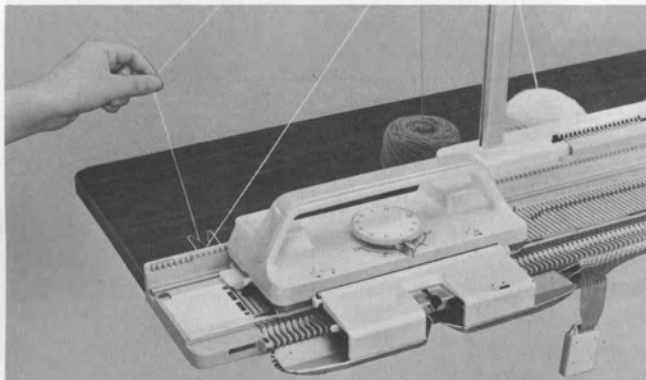

Knit 4 rows with the yarn, and exchange it for the yarn on the Yarn Rest.

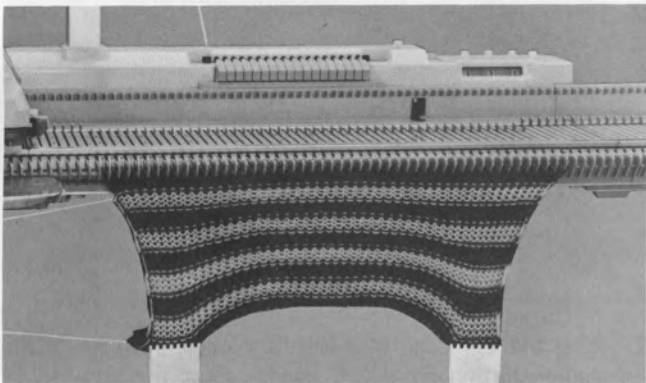

Repeat knitting exchanging the yarns every 4 rows, till the Row Counter reaches **050**

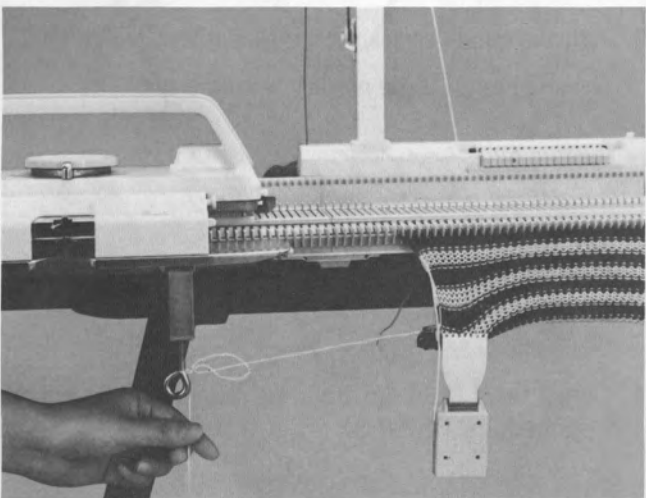

Removing the fabric – Open edge –

- Remove the yarn from the Yarn Feeder.
- Cut both yarns leaving about 10cm. and place them in the Clip on the Tension Post.
- Release the yarn end from the Clamp.

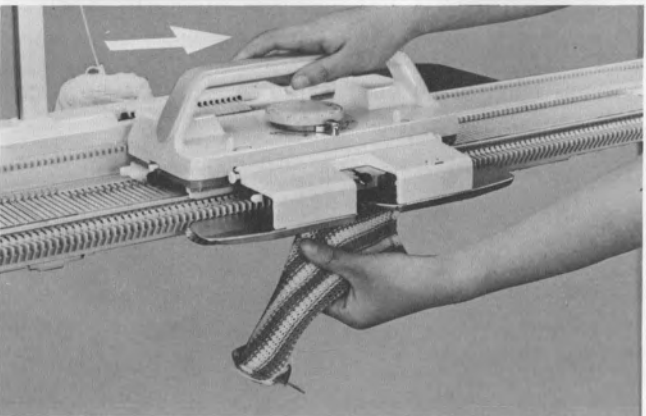

- Remove weights from the fabric.
- Move the Carriage over the needles in B position with the Cam Lever positioned at Λ mark.
The fabric will come off of the needles.

BASIC TECHNIQUES

Mock Rib, Increase, Decrease, and Cast off instructed in this section are most basic and frequently used in knitting a garment.

Practice those techniques following instructions given for each technique till you are fully convinced of.

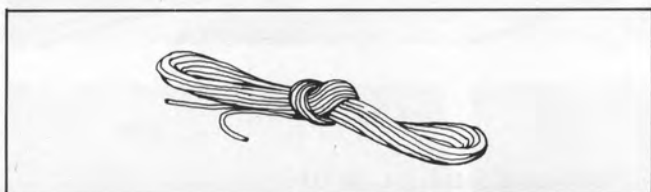
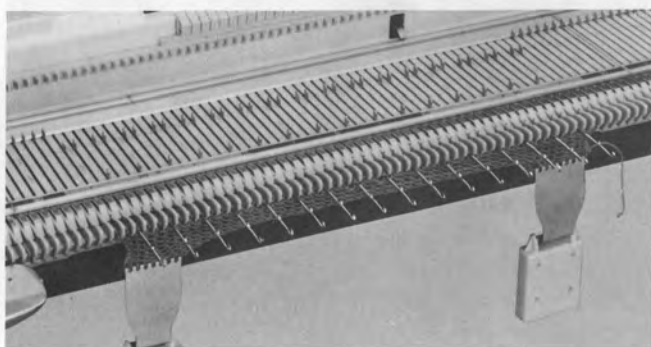
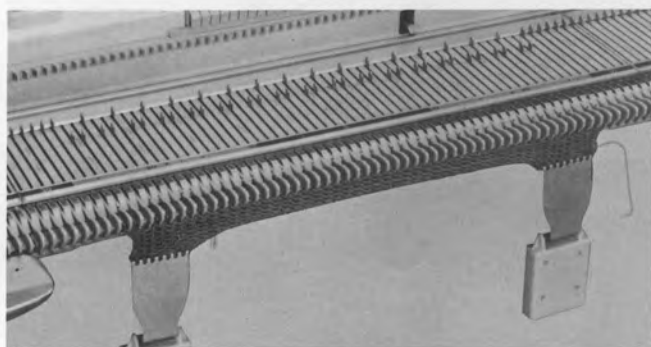

Mock Rib

Prepare a little amount of waste yarn.

1. Referring to page 13, cast on 50 stitches with the waste yarn, and knit several rows in stockinet. Then cut the yarn and remove it from the Auto-Tension.
2. Using the 2/1 edge of a Needle Pusher, push every 3rd needle starting from 3rd needle from the edge to D position.
3. Push the same needles back to A position. The stitches on those needles will drop off.
4. Take a Ravel Cord out from the Accessory Box, and set it in the Yarn Feeder ①.
5. While holding the Cord lightly so as it runs out freely, and move the Carriage slowly to knit 1 row. Remove the Cord from the Yarn Feeder.

It is recommended to cast on the number of stitches divisible by 3 plus 2 for working the mock rib.

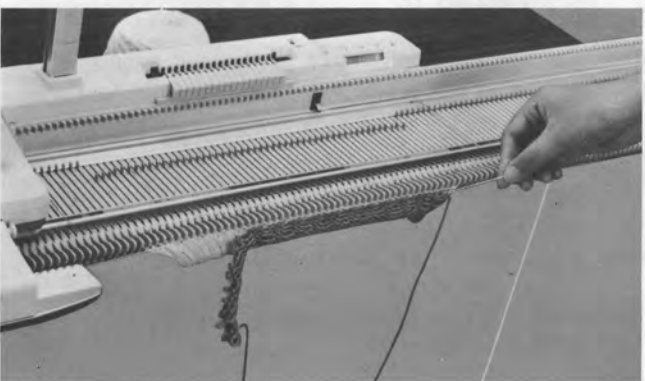
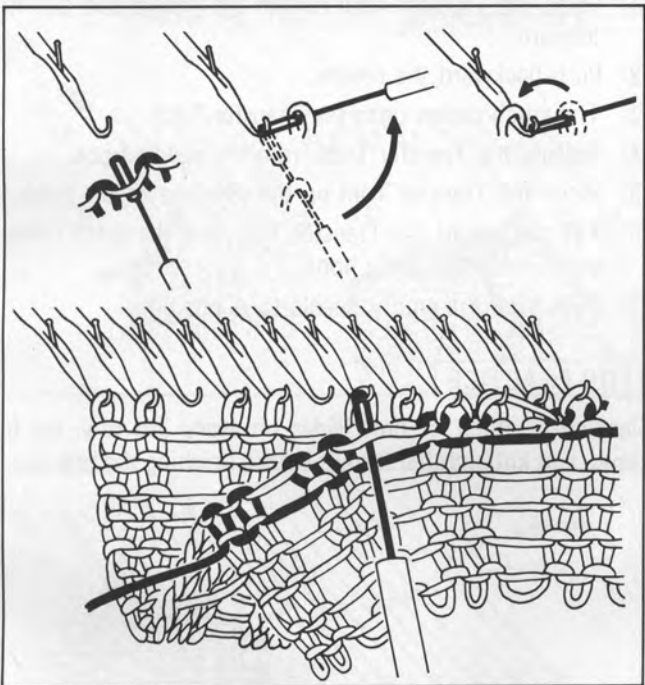
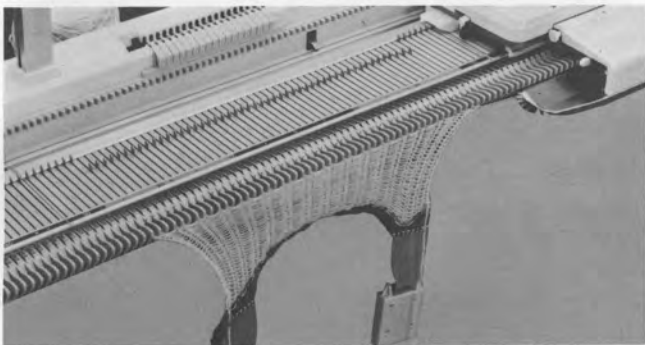
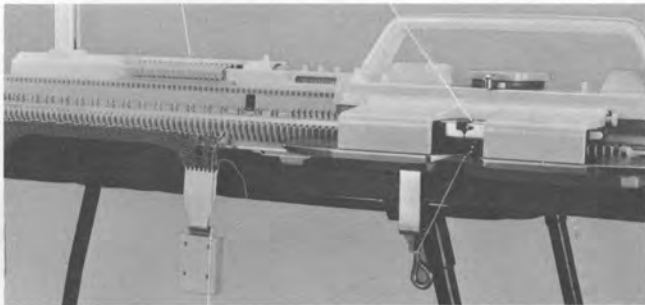

6. Release the main yarn from the Yarn Clip and place it in the Yarn Feeder ①.

Fasten the yarn end at the Clamp screw grip.

7. Set the Stitch Dial 3 numbers lower than the original number.

Set the Cam Lever at Λ .

Take up the slack on the yarn and knit the required number of rows.

FOR PRACTICE

With the Stitch Dial at 4, knit 30 rows.

Release the yarn end from the Clamp screw grip.

8. Align the needles, previously pushed back to A position, in B position.

9. Insert a one-prong Transfer Tool into the loop above the Ravel Cord, and replace the stitch onto the corresponding needle as shown.

10. Change the Stitch Dial to 7 and knit 1 row.

Pull out the Ravel Cord, and the waste knitting will be separated.

At this step, the Mock Rib is completed.

FOR PRACTICE

Knit 5 rows more before stepping forward to practice next technique.

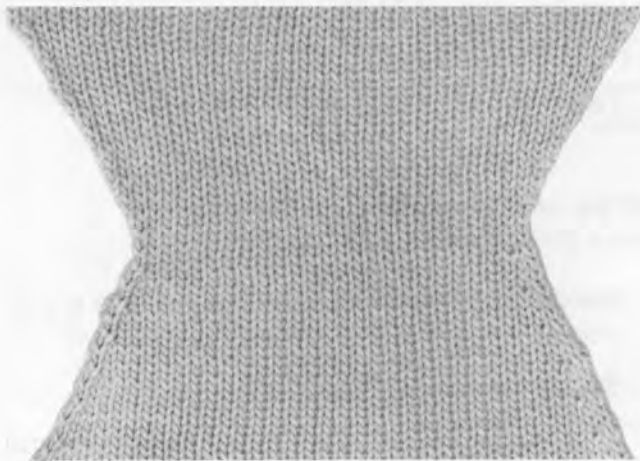

Decrease and Increase of single stitch

Decrease and increase of single stitch are most frequently used for shaping a garment.

For practice, follow the instructions given under the same title.

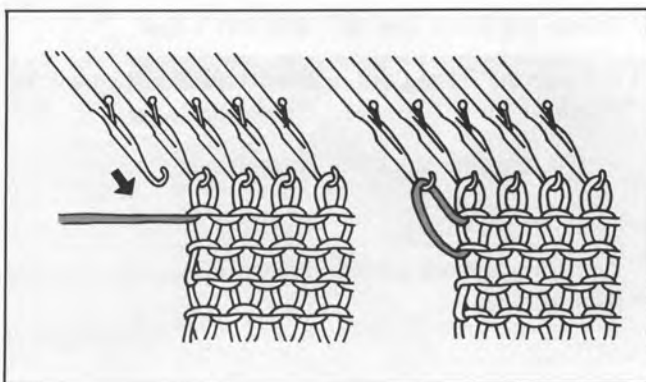
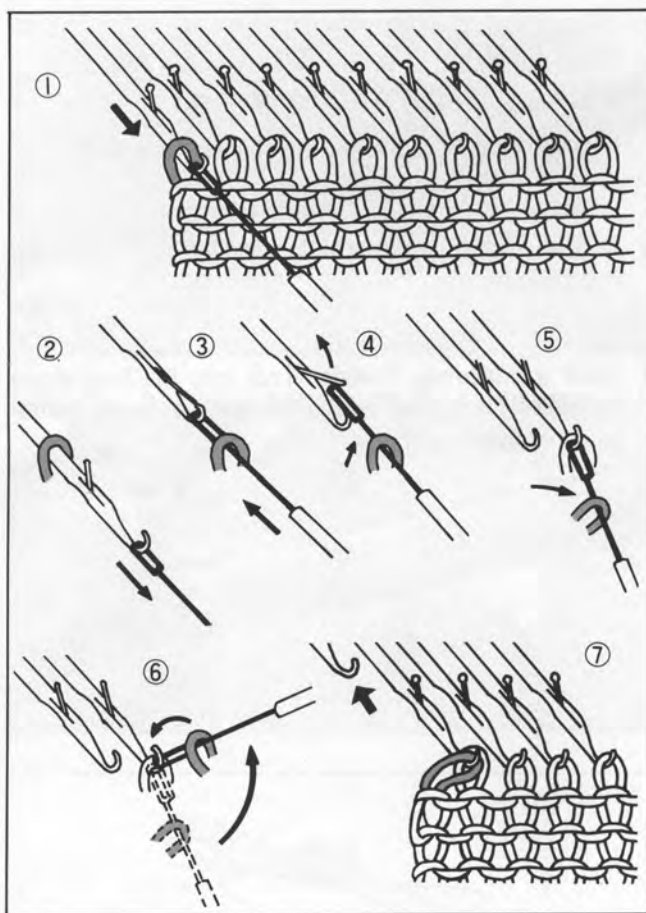

Decrease

Decrease of single stitch can be done on both sides at a time on the same row.

Using a Transfer Tool, transfer the end stitch onto its adjacent needle in the following manner.

- ① Hitch the Transfer Tool on the end needle and pull it forward.
- ② Push backward the needle.
- ③ The stitch moves onto the Transfer Tool.
- ④ Release the Transfer Tool from the needle hook.
- ⑤ Hitch the Transfer Tool on the adjacent needle hook.
- ⑥ Tilt the grip of the Transfer Tool, and the stitch slides down into the needle hook.
- ⑦ Push back the empty needle to A position.

FOR PRACTICE

Decrease a stitch at both sides on every 3rd row, for 5 times, and knit another 5 rows before finishing the practice.

Increase

Push one empty needle, next to the end needle, at the Carriage side to B position, before knitting the next row.

FOR PRACTICE

Increase at the beginning of the next and following alternate rows. Repeat every 3rd row 5 times.

Knit another 5 rows before finishing the practice.

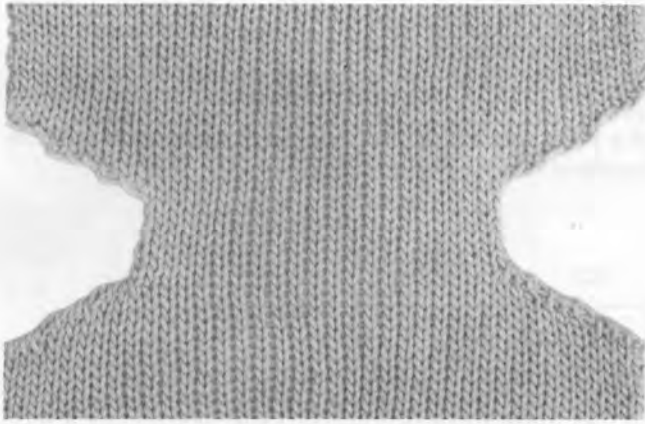

Decrease and Increase of multiple stitches

Work only on the Carriage side.

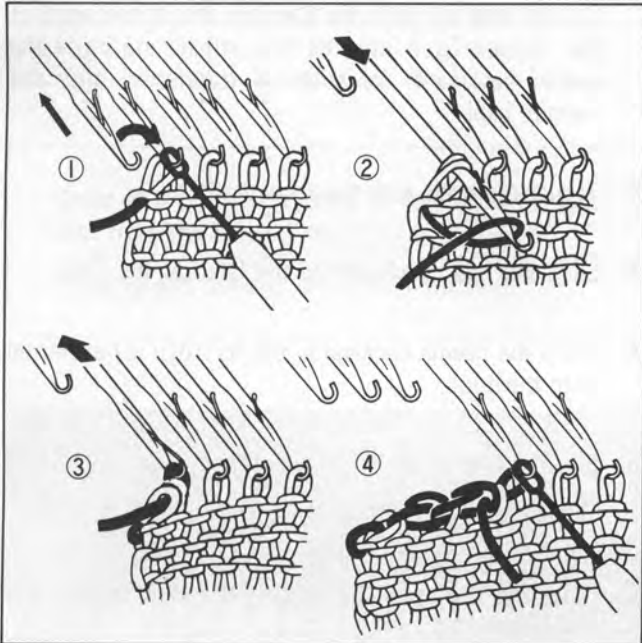

Decrease

- ① On the Carriage side, using a Transfer Tool, transfer end stitch to its adjacent needle.
Push back the empty needle to A position.
- ② Push the second needle toward D position till both stitches move over the latch.
Wind the yarn around the needle hook as shown.
- ③ Holding the yarn downward, push the needle back to B position.
Two stitches on the needle slip off and interloop with the yarn.
Repeat the above steps.
- ④ Place the last decreased stitch onto its adjacent needle.

FOR PRACTICE

Decrease 4 stitches at the beginning of the next 4 rows, and knit 10 rows.

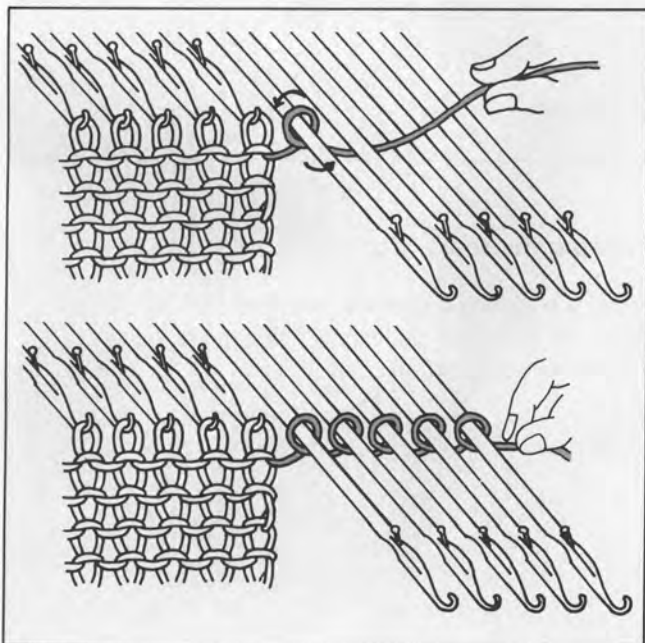

Increase

- (1) Push required number of empty needles to D position at the Carriage side.
- (2) Pull down yarn through the Yarn Feeder.
- (3) Wind the yarn around the needles in D position in the anti-clockwise direction*.
Slide the each loop on the needles backward with your finger.
- * When the Carriage is at the left side of the fabric, wind the yarn around the needles in the clockwise direction.
- (4) Take up slack on the yarn and continue to knit with the Russel Lever at II position.

FOR PRACTICE

Increase 4 stitches at the beginning of the next 4 rows, and knit 10 rows.

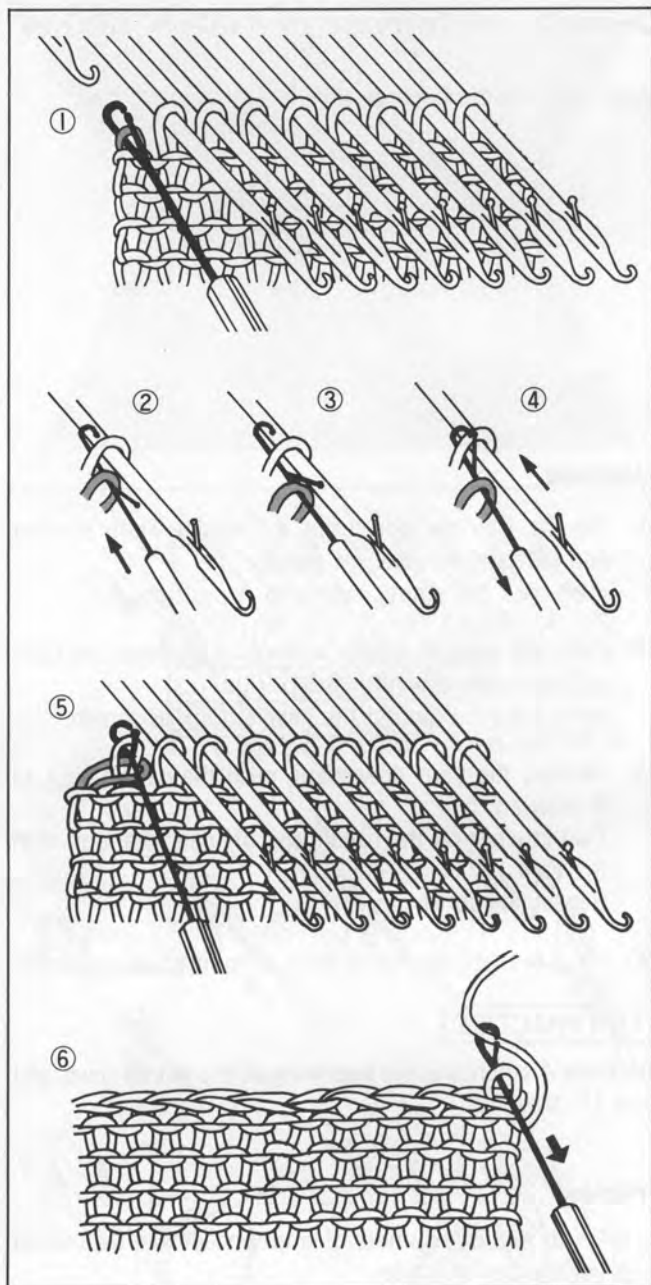

Cast off

Knit the cast off row with the Stitch Dial 3 numbers higher.

If a thick yarn is used, knit the cast off row with a medium yarn and the Stitch Dial at 10.

FOR PRACTICE

Knit the cast off row with the Stitch Dial at 10.

- ① Push the needles to D position.
On the side opposite the Carriage, thrust the hook of the Tappet Tool into the first stitch, and move the needle backward. Its stitch is transferred onto the Tappet Tool.
- ② Thrust the hook into the second stitch.
- ③ Slide the first stitch behind the latch of the Tool.
- ④ Move the needle backward, and its stitch is transferred onto the hook.
- ⑤ Slip the first stitch off of the Tappet Tool.
Repeat steps ② – ⑤
- ⑥ Close the last stitch by guiding the yarn through the stitch with the Tool.

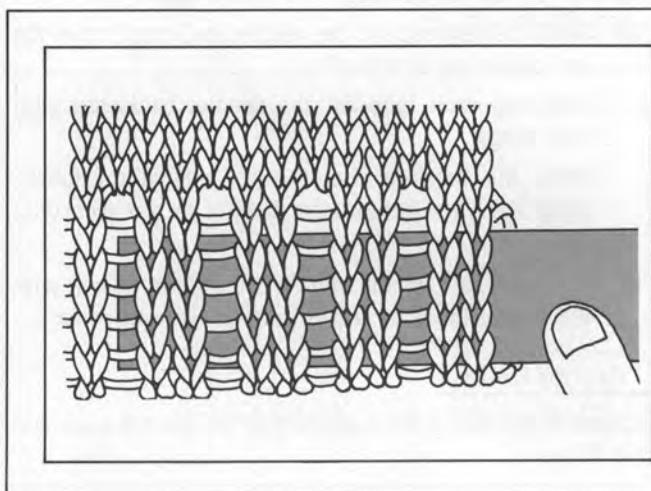

Pressing the mock rib

Insert a ruler-like object into the side opening of the mock rib, and while pulling the fabric, press the mock rib lightly with a steam iron.

GETTING TO KNOW ABOUT PATTERN KNITTING

1	2	3	4	5	6	7	8	9
①	I	●		^	●	A		→
②	1~2	▼	"	∩	●	"		⇄)2
③	3~4	"	"	"	"	B		⇄)2

Order ① is preparatory step to memorize the pattern from the Punch Card.

Order ② and onward for pattern knitting.

Operation Table

On each pattern stitch, the Operation Table as shown opposite is given to instruct the settings and operation of the machine.

- 1 – Order of operation
- 2 – Card Memory Number, its setting and progress
- 3 – Card Lever
- 4 – Russel Lever
- 5 – Cam Lever
- 6 – Cast-on Lever
- 7 – Yarn Feeder ①
- 8 – Yarn Feeder ②
- A, B: yarns in the Yarn Feeder.
- 9 – Carriage direction:
numbers beside the arrows indicates number of rows to be knitted.

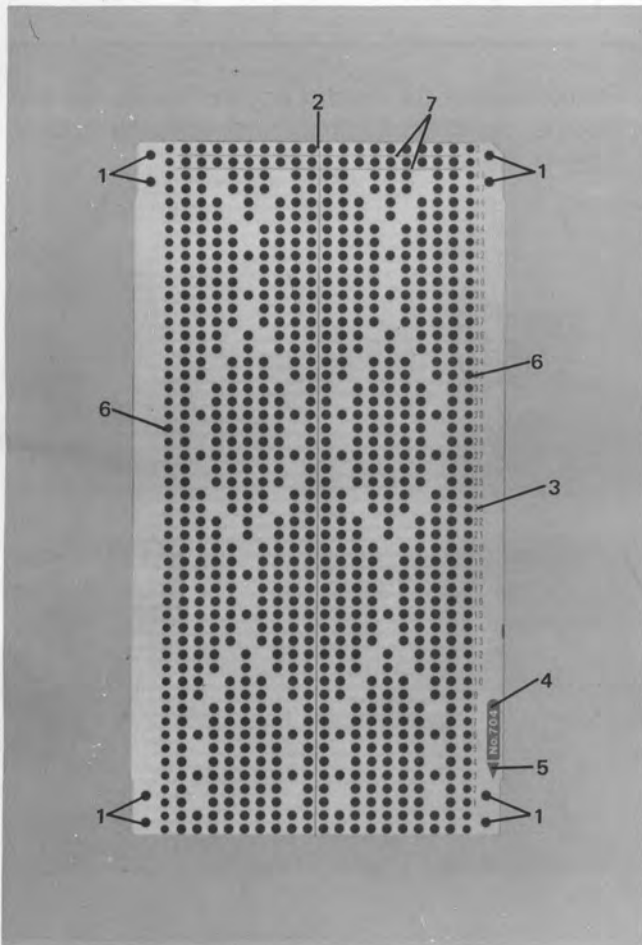

Punch Card

Five sheets of Punch Card are included with the machine. Pattern is punched on the Card and knitted on the fabric automatically.

Each Punch Card carries the following notations.

- 1 – Snapping Holes
- 2 – Centre Line
- 3 – Card Memory Number
- 4 – Card Number
- 5 – Inserting Direction
- 6 – Feeding Holes
- 7 – Card Setting Lines

DO NOT EXPOSE THE CARD TO DIRECT SUNLIGHT or HEATS, the Card will be deformed.

Do not fold the Punch Card.

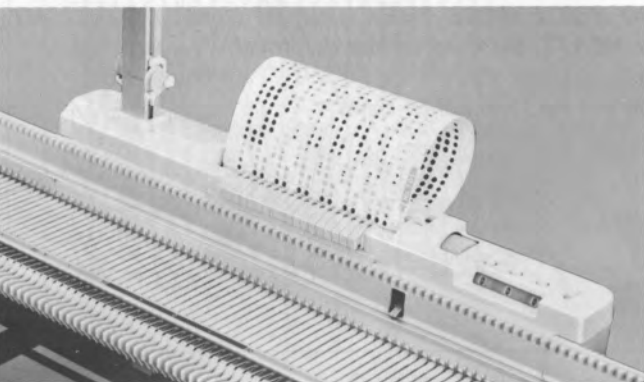
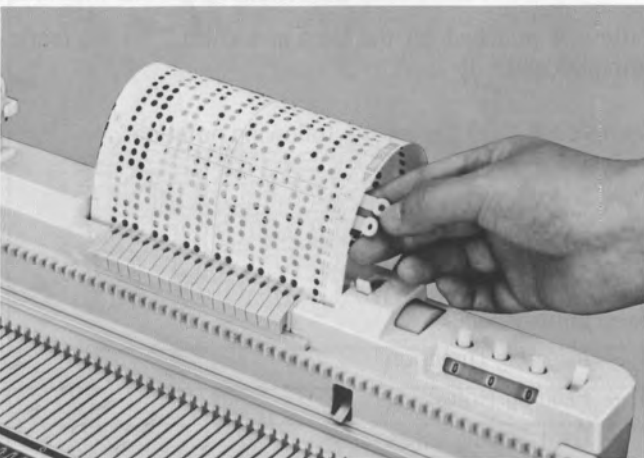
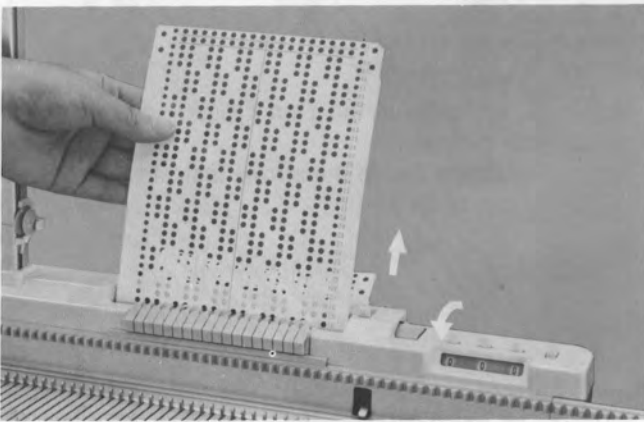
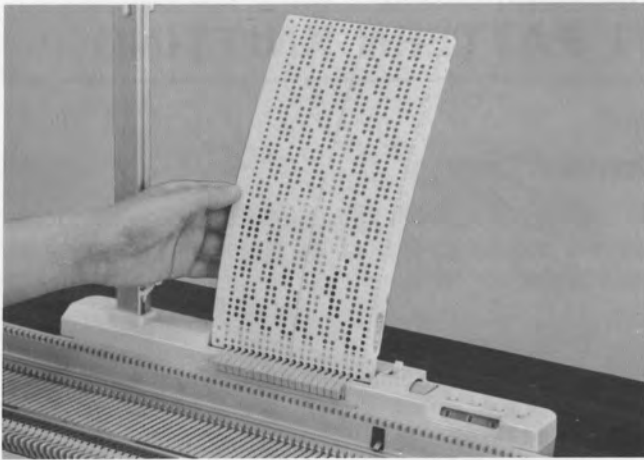

Setting Punch Card

1. Insert the bottom end of a Punch Card horizontally in the slit at the centre of the needle bed.

2. Turn the Card Dial till the bottom end of the Card comes out from the rear side.

3. Further advance the Punch Card, and lap the top end over the bottom end to join them together with the Card Snaps as shown.

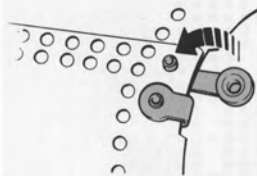

4. By turning the Card Dial, set the Card Memory Number "1" on the Punch Card at the position flush with the front edge of the slit.

5. Lock the Card by setting the Card Lever at ● mark.

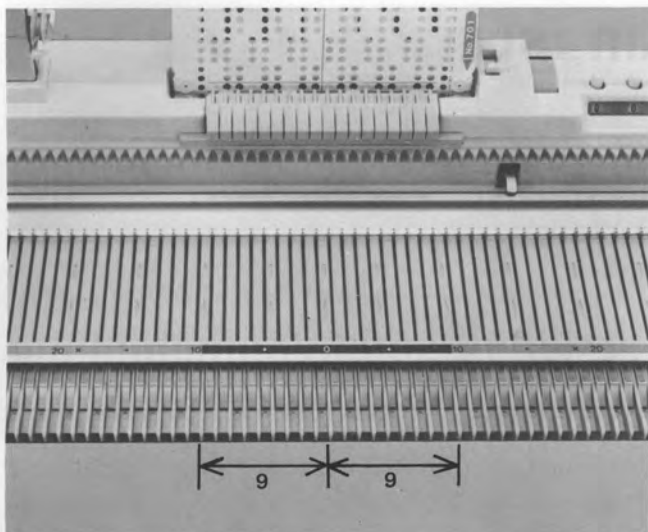

Punch Card and pattern positions

A pattern on the Punch Card is 18-stitch wide and knitted repeatedly at the predetermined positions, which are marked on the needle bed with alternate colourings.

In each 18-needle width on the needle bed, partitioned with alternate colourings, "X" mark is given to indicate that the needle at the mark knits the center of the pattern on the Punch Card.

Stitch Type Punch Card	KNIT-IN	TUCK	SLIP
No.701	○		○
No.702	○	○	○
No.703	○	○	○
No.704		○	○
No.705	○		

A Card for various stitch types

According to the Cam Lever setting, each Punch Card can knit various stitch types as shown in the table opposite.

Various pattern stitches knitted with each Punch Card are shown on the separate pattern sheet.

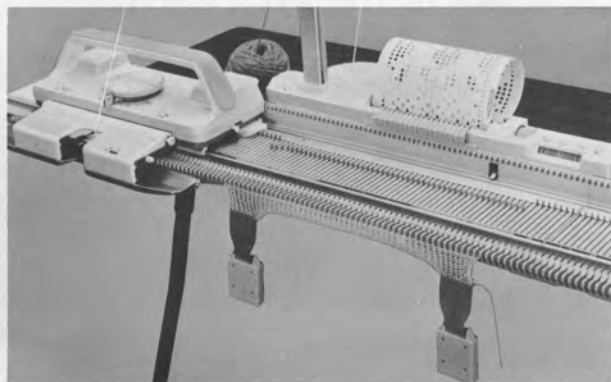

For success in pattern knitting

Before starting to knit pattern stitches, cast on and knit 9–10 rows in stockinet.

Hang the Claw Weights on both ends of the fabric, and move them up as knitting progresses.

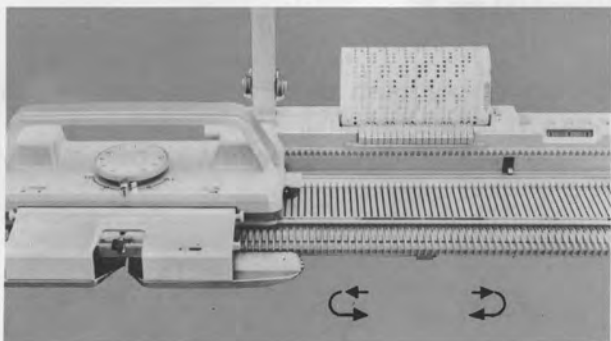

Be sure to move the Carriage past the Punch Card on every row in order to memorize the pattern correctly.

Move the Carriage at an even speed.

KNIT-IN (FAIR ISLE)

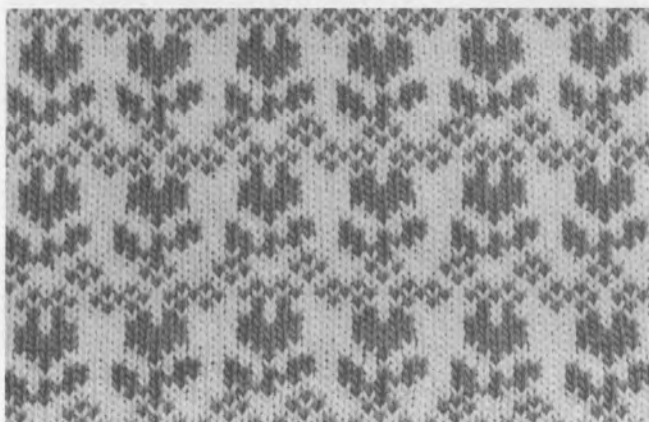

①		●	^ ●	A →
②	~	▼	" ^ ● "	B ⇄

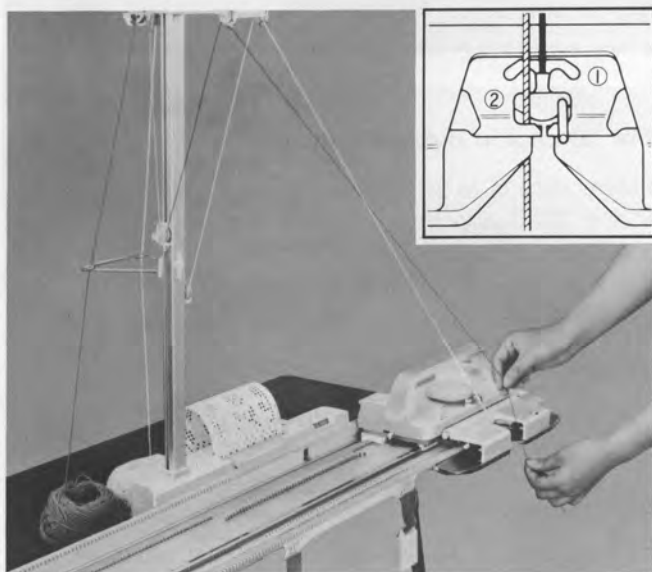

KNIT-IN pattern is formed with two yarns of different colours – one is for ground yarn, and the other for contrast yarn to be knitted by the selected needles according to the Punch Card.

The photograph opposite shows the knit-in pattern knitted with a Punch Card No.705.

Knit the Knit-in pattern in the following procedure.

- Thread two yarns (A, B.) through the Auto-Tension, and place them in the Clips.
- With a yarn (A), cast on and knit several rows with the Cam Lever at \wedge mark.

Above two steps are not required if a knitted fabric is on the needles.

- (1) Insert a Punch Card, and lock at Card Memory Number "1".
- (2) As required in the Order ① of the Operation Table, place the yarn (A) in the Yarn Feeder ①.
- (3) Knit 1 row from left to right with the Cam Lever at \wedge mark. TO MEMORIZE PATTERN.
- (4) Change the settings of the Carriage as required in the Order ② of the Operation Table.
 - Set the Card Lever at ▼ mark.
 - Place the second yarn (B) in the Yarn Feeder ②.
 - Set the Cam Lever at \wedge mark.
- (5) Push the first needle to D position.
- (6) Knit 1 row.

Repeat (5) and (6).

On every row, push the first knitting needle to D position before knitting.
(In partial knitting push the first knitting needle to C position.)

SLIP STITCH

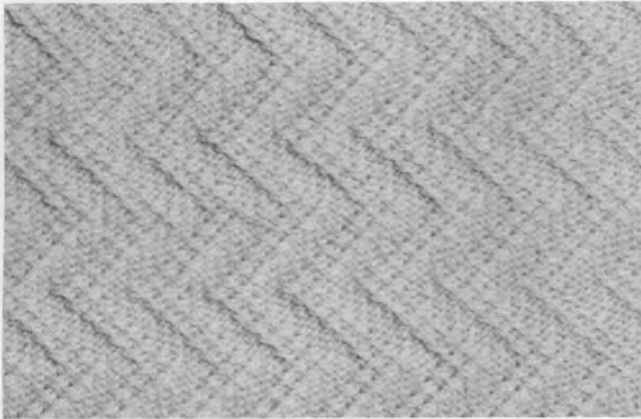

SLIP STITCH is formed by a loop below the needle and stitch knitted on the needle.

The photograph opposite shows the slip stitch pattern knitted with a Punch Card No.702.

Knit the slip stitch pattern in the following procedure.

①		●		Λ	●	A	→
②	~	▼	"	⊖	●	"	⇄

– Thread a yarn through the Atuo-Tension and place it in the Clip.

– Place the yarn in the Yarn Feeder ①, cast on and knit several rows with the Cam Lever at Λ mark.

Above two steps are not required if a knitted fabric is on the needles.

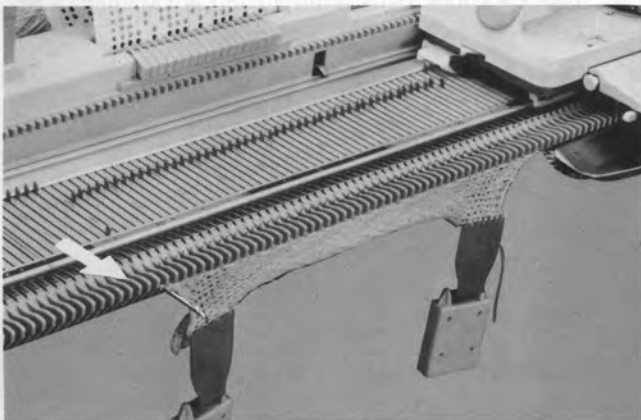

(1) Insert a Punch Card, and lock at Card Memory Number "1".

(2) As required in the Order ① of the Operation Table, place the yarn (A) in the Yarn Feeder ①.

(3) Knit 1 row from left to right with the Cam Lever at Λ mark. TO MEMORIZE PATTERN.

(4) Change the settings of the Carriage as required in the Order ② of the Operation Table.

– Set the Cam Lever at ⊖ mark.

– Set the Card Lever at ▼ mark.

(5) Push the last needle to D position.

(6) Knit 1 row.

Repeat (5) and (6).

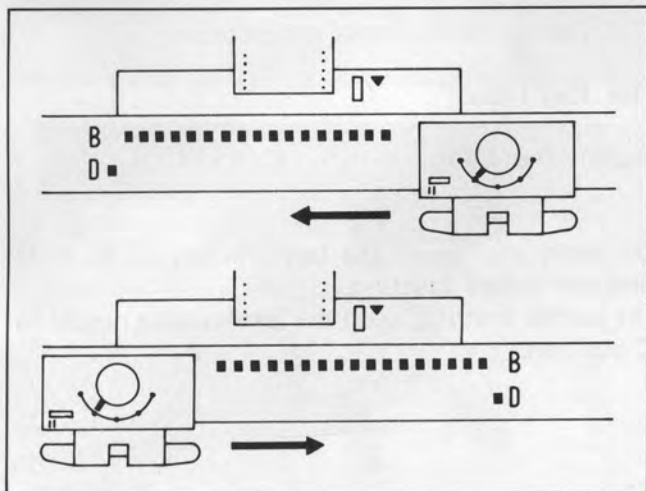

On every row, push the last knitting needle to D position before knitting.

(In partial knitting, push the last knitting needle to C position.)

TUCK STITCH

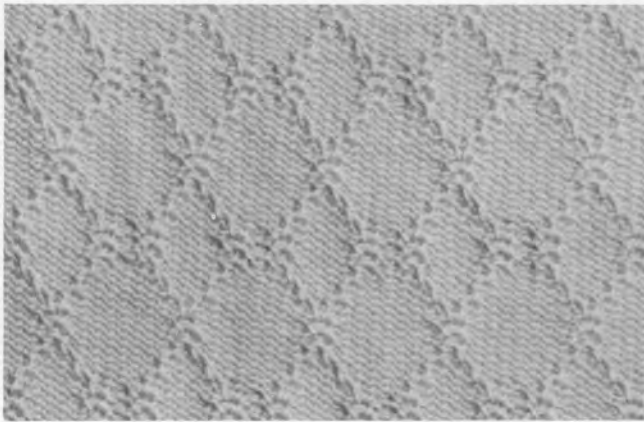

TUCK STITCH is formed by the loops held in the needle hook, and a new loop which knits those held loops together.

The photograph opposite shows the tuck stitch pattern knitted with the Punch Card No.704.

①		●		∧	●	A	→
②	-	▼	"	∩	●	"	⇔



Knit the tuck stitch pattern in the following procedure.

- Thread a yarn through the Auto-Tension and place it in the Clip.
- Place the yarn in the Yarn Feeder ①, cast on and knit several rows with the Cam Lever at ∧ mark.

Above two steps are not required if a knitted fabric is on the needles.

- (1) Insert a Punch Card, and lock at Card Memory Number "1".
- (2) As required in the Order ① of the Operation Table. Place the yarn in the Yarn Feeder ①.
- (3) Knit from left to right with the Cam Lever at ∧ mark. TO MEMORIZE THE PATTERN.
- (4) Change the settings of the Carriage as required in Order ② of the Operation Table.
 - Set the Card Lever at ▼ mark.
 - Set the Cam Lever at ∩ mark.

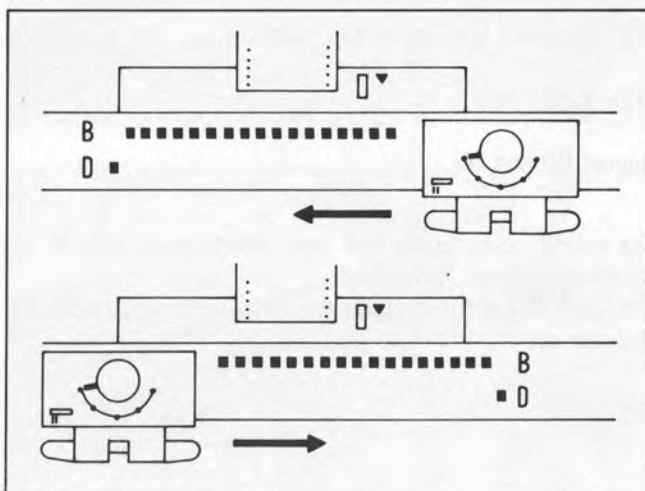

- (5) Push up the last needle to D position.

- (6) Knit 1 row.

Repeat (5) and (6).

On every row, push the last knitting needle to D position before knitting. (In partial knitting, push the last knitting needle to C position.)

TUCK / SLIP STITCH IN COLOURS

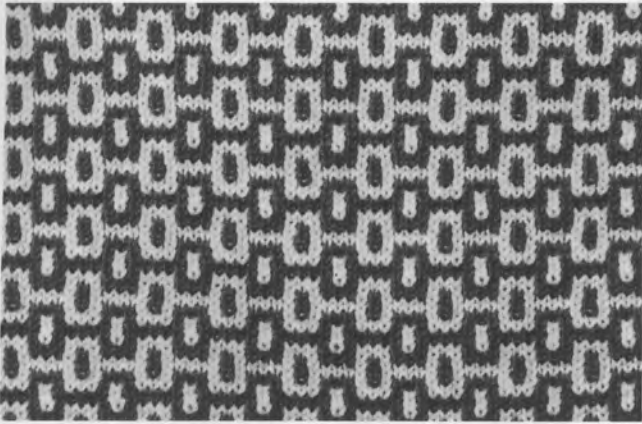

Two yarns are knitted in the tuck or slip stitch pattern, and the different pattern effect will be knitted on the fabric.

The photograph opposite shows the tuck stitch pattern in two colours knitted with a Punch Card No.703.

By setting the Cam Lever either at \wedge or \ominus mark, you can knit the pattern in tuck stitch or slip stitch in the same procedure set forth below.

①	I	●	II	\wedge	●	A		→	
②	1~2	▼	"	\wedge / \ominus	●	"		⇒	2
③	3~4	"	"	"	"	B		⇒	2

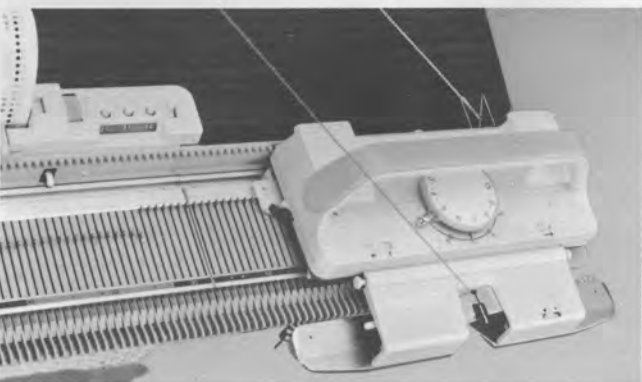

– Thread two yarns (A, B) through the Auto-Tension, and place them in the Clip.

– Place the yarn (A) in the Yarn Feeder (1), cast on and knit several rows with the Cam Lever at \wedge mark.

Above two steps are not required if a knitted fabric is on the needles.

(1) Insert a Punch Card, and lock at Card Memory Number "1".

(2) As required in the Order ① of the Operation Table, place the yarn (A) in the Yarn Feeder ①.

(3) Knit from left to right with the Cam Lever at \wedge mark. TO MEMORIZE THE PATTERN.

(4) Change the settings of the Carriage as required in the Order ② of the Operation Table.

– Set the Card Lever at ▼ mark.

– Set the Cam Lever at \wedge mark or \ominus mark.

(5) Knit two rows with the yarn (A), pushing up the last needle to D position on every row.

(6) Exchange the yarn (A) for (B). Place the Yarn (A) in the Yarn Rest.

(7) Knit two rows.

Repeat steps (5) – (7).

On every row, push the last knitting needle to D position before knitting.

(In partial knitting, push the last knitting needle to C position.)

CORD KNITTING

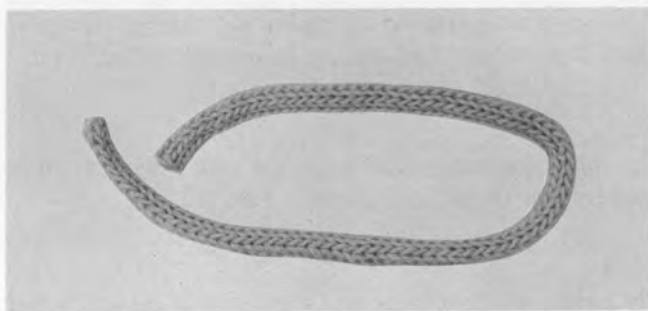

↓	+7 +6 +5 +4 +3 +2 +1						
●	●	II	⤴	●	A	→	→

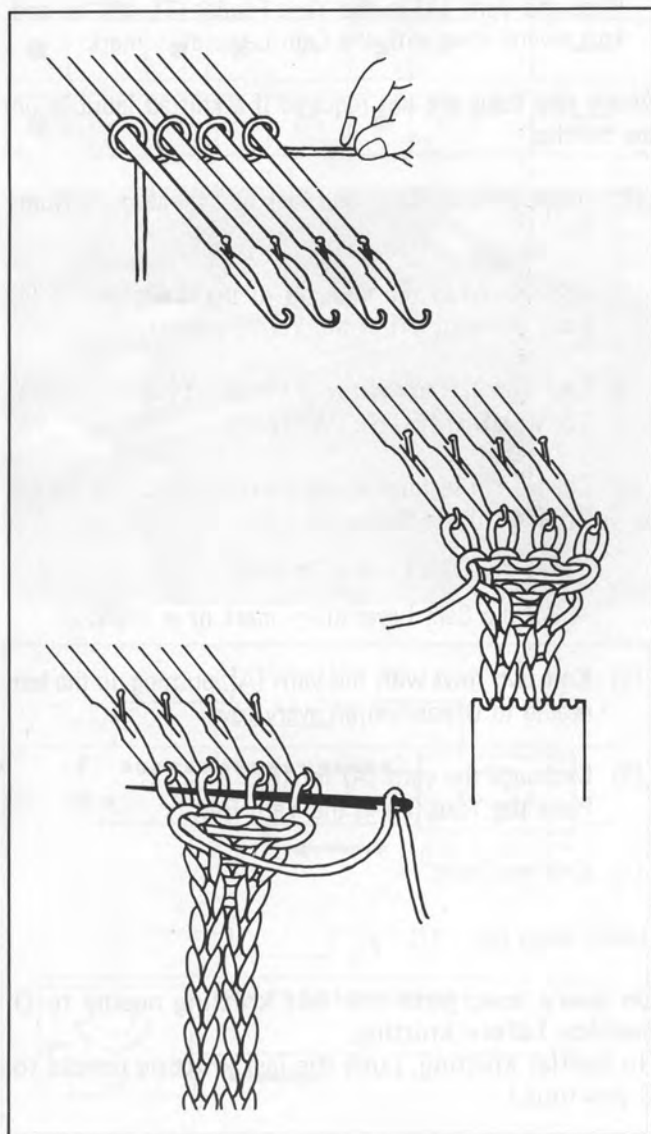

This function is very useful to knit a cord, and only used for knitting a cord.

No Punch Card is necessary.

Knit the cord in the following procedure.

– Thread a yarn through the Auto-Tension and place it in the Clip.

- (1) Place the Carriage at the right side on the needle bed.
- (2) At the centre of the needle bed, push up 4–5 needles to D position.
- (3) Pull down the yarn from the Auto-Tension, and wind it around each needle as shown. Slide the each loop on the needle backward.
- (4) Place the yarn in the Yarn Feeder, and pull the yarn toward the yarn ball at the back of the Tension Post.
- (5) Set the Carriage as required in the Operation Table.
 - Set the Russel Lever at **II**.
 - Set the Cam Lever at **⤴** mark.
- (6) After knitting several rows, hang weight on the cord. Knit for required length.
- (7) Finish knitting with the Carriage at the left side.
- (8) Cut the yarn leaving 10cm. and cast off the stitches with a Tapestry needle as shown.

TAKING A TENSION GAUGE



Your success in knitting greatly depends on taking a correct **tension gauge**.

As compared with cloths, yarn itself is elastic by nature and a size of a knitted garment is more influenced by the quality and thickness of the yarn, and also by the selected stitch type.

In order to knit a garment correctly to desired size, it is very important to know, before knitting a garment, how many rows and stitches are required in the selected stitch type and Stitch Dial. To know the number of stitches and rows for 10cm. square is taking a tension gauge.

To count the stitches and rows one by one is not easy on the knitted fabric of complicated stitch type. But you will be free from the complicated counting, as a special scale will help you know quickly and easily the tension gauge.

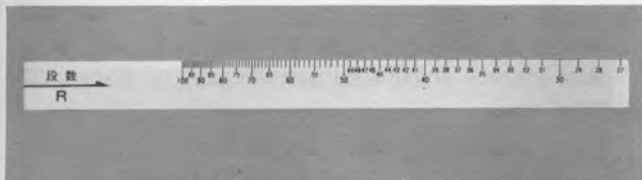
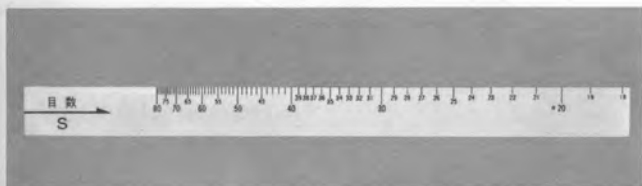

Gauge Scale

This Gauge Scale is so designed to convert the length of 40 stitches and 60 rows into so many stitches and rows for 10cm. square.

It is two sided, the side with "S" is used for measuring the Stitch, and the side "R" for rows.

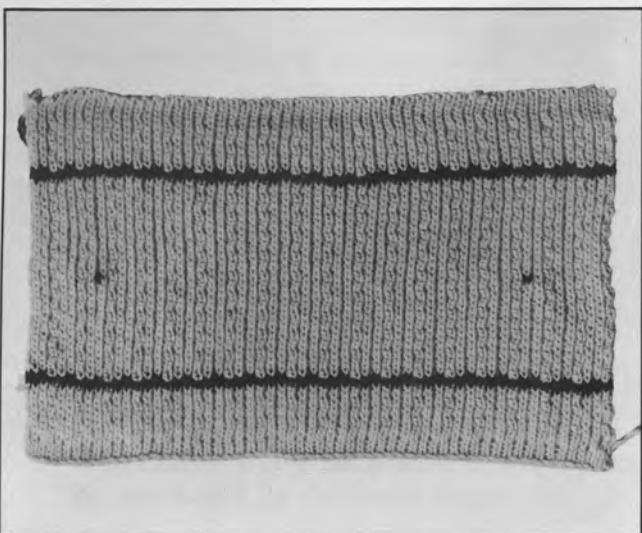

Tension Swatch

The tension swatch is knitted with the same yarn and in the same stitch type as to be used for the garment.

To use the Gauge Scale, the tension swatch must be knitted in the predetermined manner as instructed in details on next page.

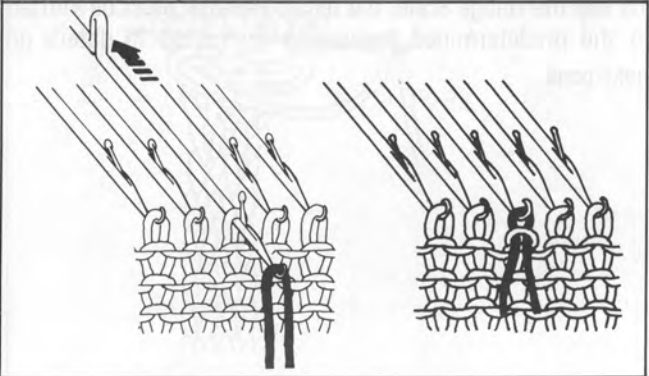
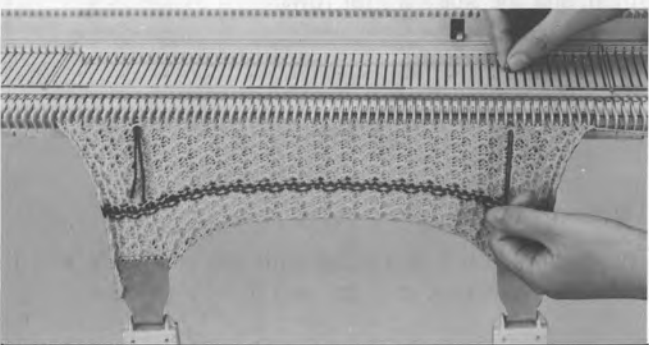
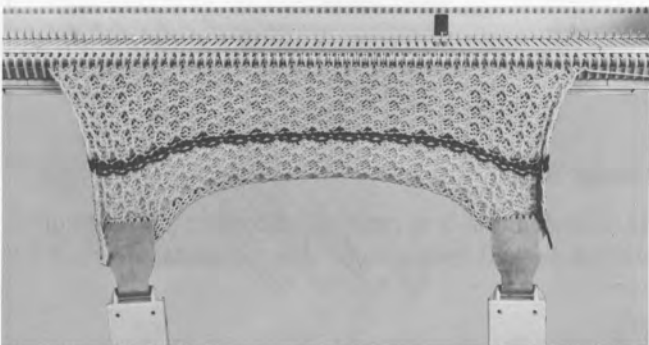
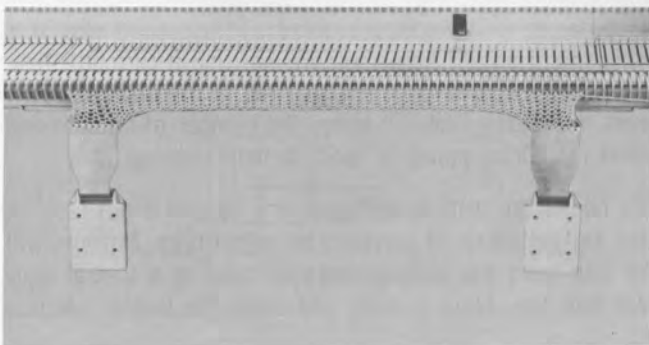
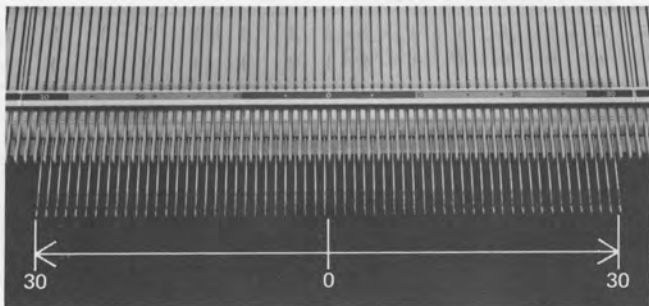

Knitting a tension swatch

1. Arrange 30 needles on both sides of the centre(0), 60 needles in total, for cast on.
(Set a Punch Card and lock at Card Memory Number "1", if a Punch Card is to be used. – refer to page 24.)

2. With the selected yarn, cast on, and knit 10 rows in stockinette continuously.
(Set the Cam Lever to selected position if a Punch Card is used.)

3. Knit 20 rows.

4. With a contrast yarn, knit 2 rows in stockinette.

5. Replace the contrast yarn with the main yarn, and knit 30 rows.

6. Push 21st needles from the centre(0) to D position, and place a piece of contrast yarn in each of those needle hook.
Then push those needles back toward B position by hand.

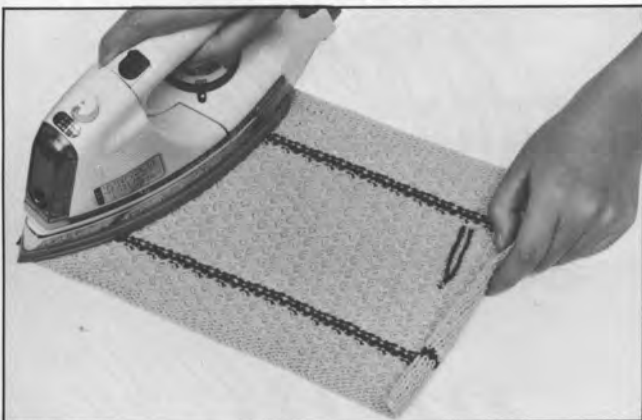
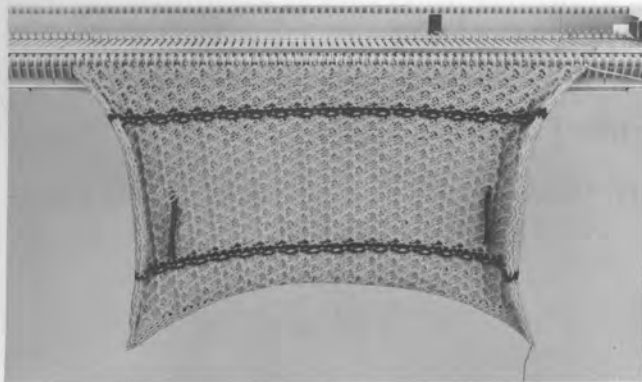

7. Knit another 30 rows.

8. Replace the contrast yarn in the Yarn Feeder, and knit 2 rows in stockinet.

9. Replace the main yarn with the contrast yarn, and knit 20 rows.
Remove the swatch from the machine.

TAKE NOTE OF THE STITCH DIAL NUMBER.

10. Allow several hours for the swatch to return to its natural condition.

Press the fabric lightly over a damp cloth.

How to measure the tension swatch

Stitch (Horizontal)

Place the Gauge Scale, with the "S" side up, onto the tension swatch so as the left end of the Scale is touching the inside of the stitch in a contrast yarn. Measure to the point of the other contrast stitch and the number which corresponds with this stitch.



Row (Vertical)

Place the Gauge Scale, with the "R" side up, onto the tension swatch so as it covers the length in between the rows knitted in a contrast yarn. Measure this length and the number indicated on the Scale.

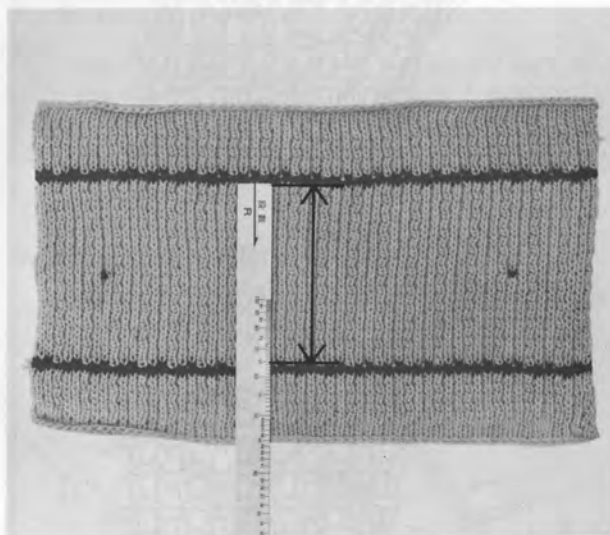

Those readings on the Gauge Scale, on the "S" side for number of stitches and "R" side for number of rows, are requirements for the Tension Gauge.

KNITTING TECHNIQUES

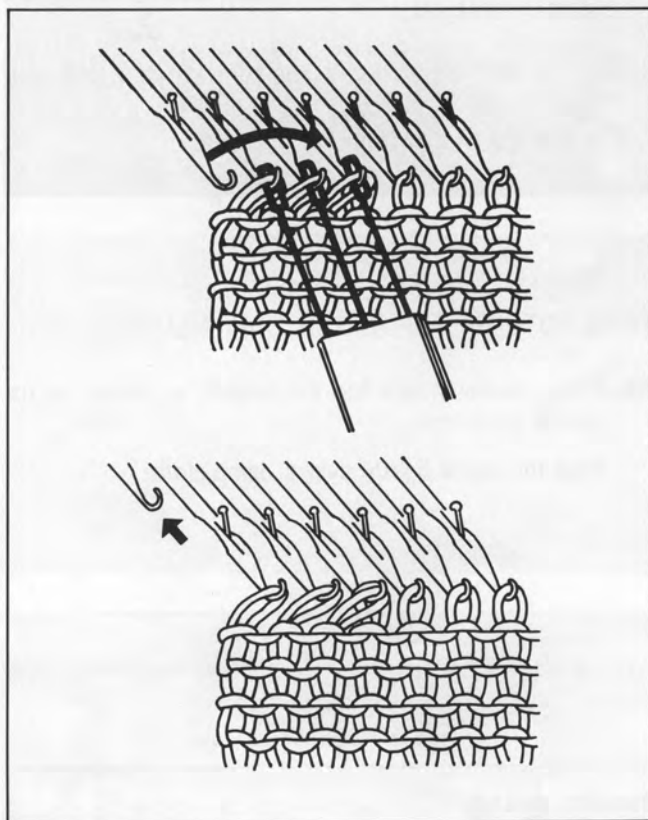

Fully Fashioned Decrease

(1) Transfer the end three stitches at the same time to adjacent needles respectively.

(2) Push the end empty needle back to A position. Continue to knit.

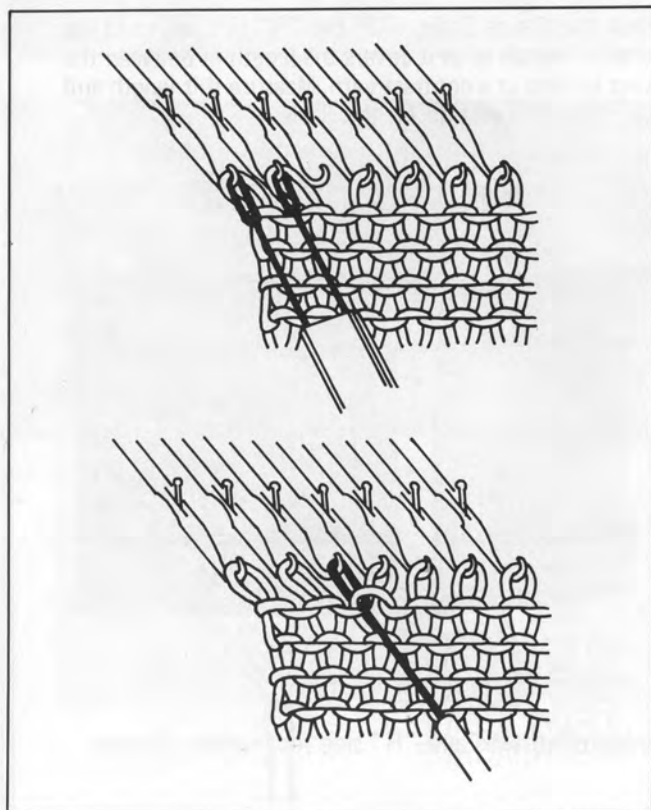

Fully Fashioned Increase

(1) Transfer the end 2 stitches onto their outside adjacent needles respectively.

(2) Pick up the loop below the third stitch and place it onto the empty needle as shown. Continue to knit.

PARTIAL KNITTING is a practical method for shaping a gentle slope, such as a shoulder, bust darts and so on.

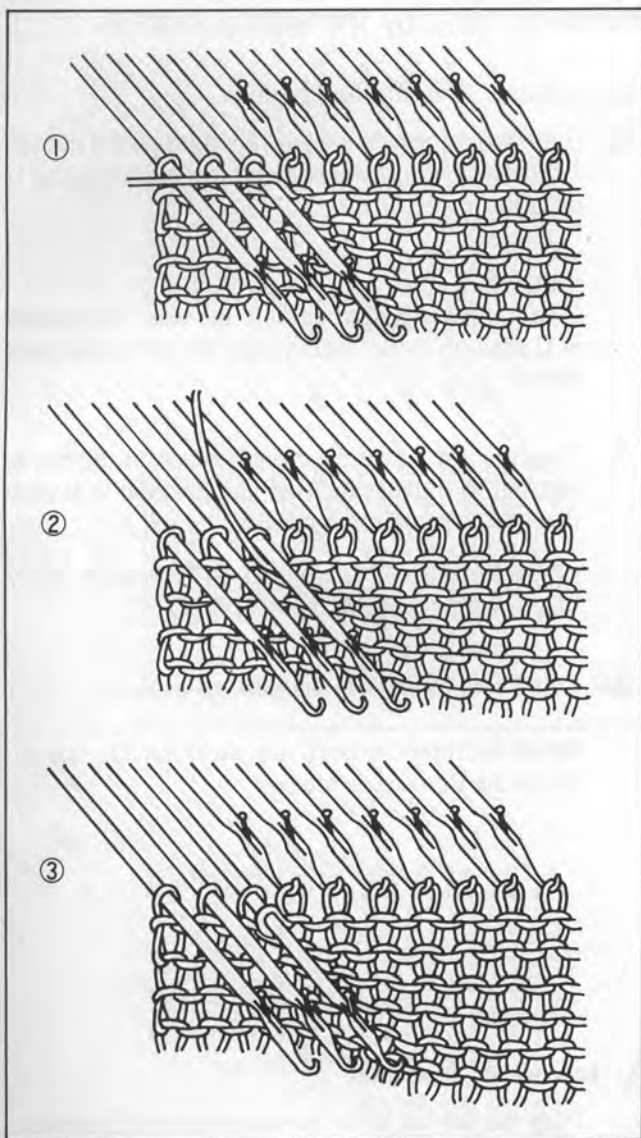

Partial Knitting by decreasing stitches

Set the Russel Lever to the **I** position.

- ① Push up the needles to be decreased, to D position, on the opposite side of the Carriage.

Knit 1 row. (The needles in B position knit the yarn. The needles in D position remain inactive and the yarn passes over them.)

- ② To prevent a hole from being formed in the fabric, pass the yarn under the first inside needle in D position and over the other needles.

(If partial knitting is required on both sides, apply step ① before knitting the next row.)

- ③ Knit 1 row by moving the Carriage back. This completes the first operation of partial knitting.

Repeat steps ① – ③

At the completion of partial knitting, work as follows to knit continuously.

A. In case of stockinet

Set the Russel Lever to **II** position and knit, (or push the needles in D position back to C position on the side opposite the Carriage if the partial knitting has been done on both sides of the fabric before knitting the next row.).

B. In case of pattern knitting

With a Transfer Tool, push the needles in D position towards B position placing their stitches into the hooks as shown below and align the needles in B position.

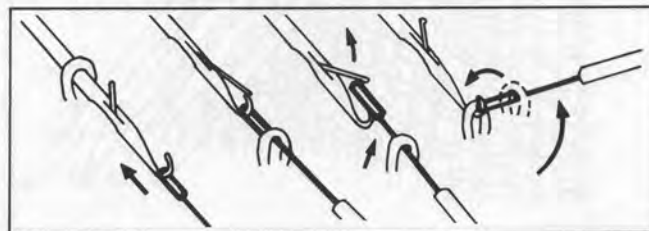

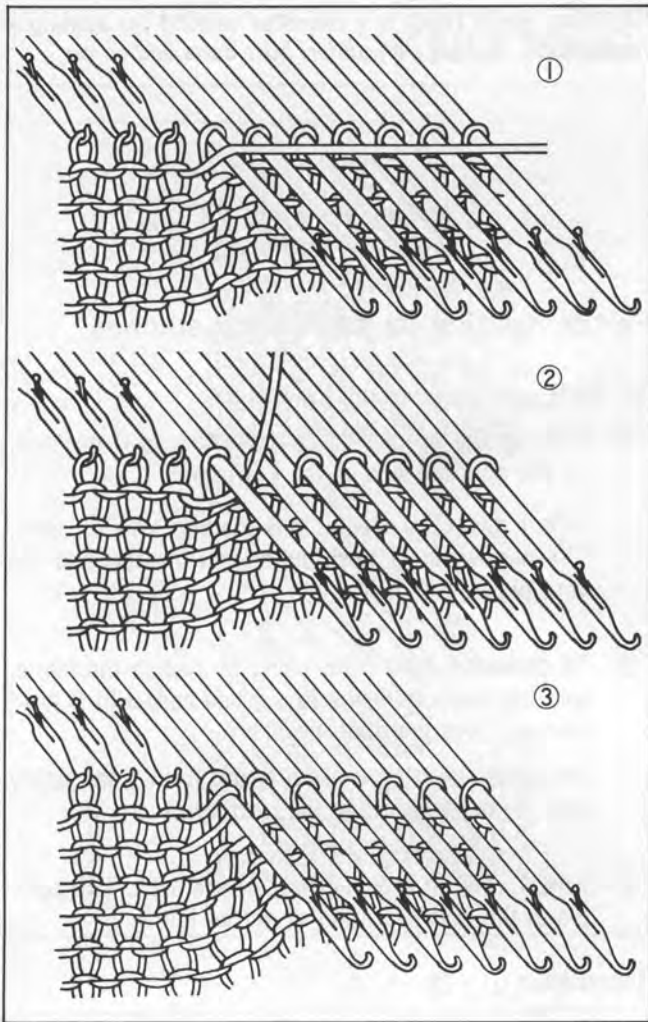

Partial Knitting by increasing stitches

Set the Russel Lever to the I position.

- ① On the side opposite the Carriage, push up the needles for the width to be shaped by partial knitting to D position.

Knit 1 row.

(The needles in B position knit the yarn. The needles in D position remain inactive and the yarn passes over them.)

- ② To prevent a hole from being formed in the fabric, pass the yarn under the first inside needle in D position and over the other needles.

(If partial knitting is required on both sides, apply step ① before knitting the next row.)

- ③ Knit 1 row by moving the Carriage back.

Before knitting the next row, work on the side opposite the Carriage as follows.

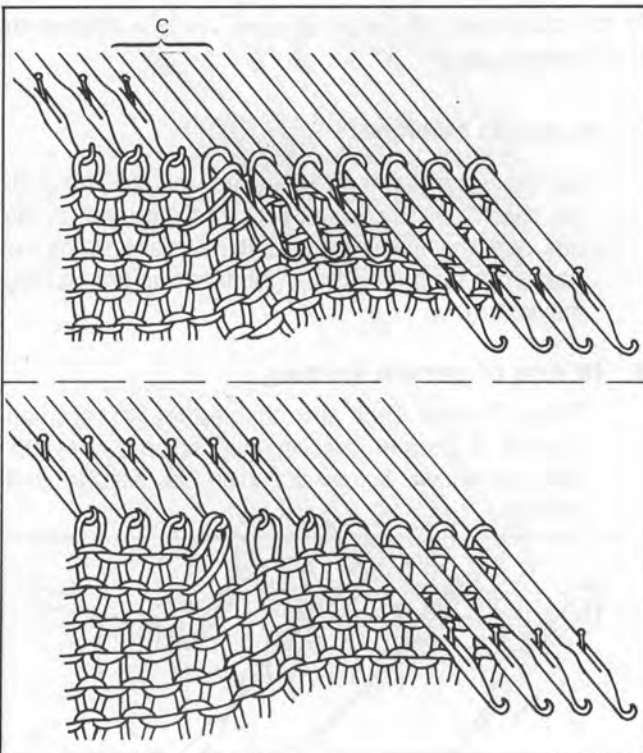

A. In case of stockinet

Push the needles to be increased back to C position.

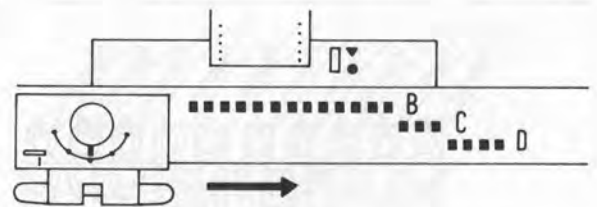

B. In case of pattern knitting

With a Transfer Tool, push the needles to be decreased towards B position placing their stitches into the hooks. Align the needles in B position.

Repeat steps ② – ③.

When knitting separately as for the neckline, apply these methods to hold the stitches for latter work.

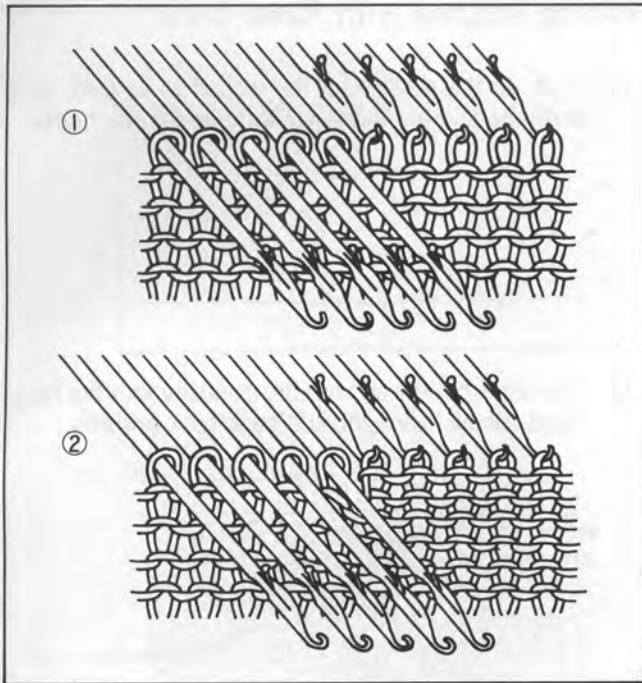

Holding stitches in D position

- ① Push up the needles for the section to be held, to D position.
- ② Set the Russel Lever to the I position and continue to knit for the needles in B position.

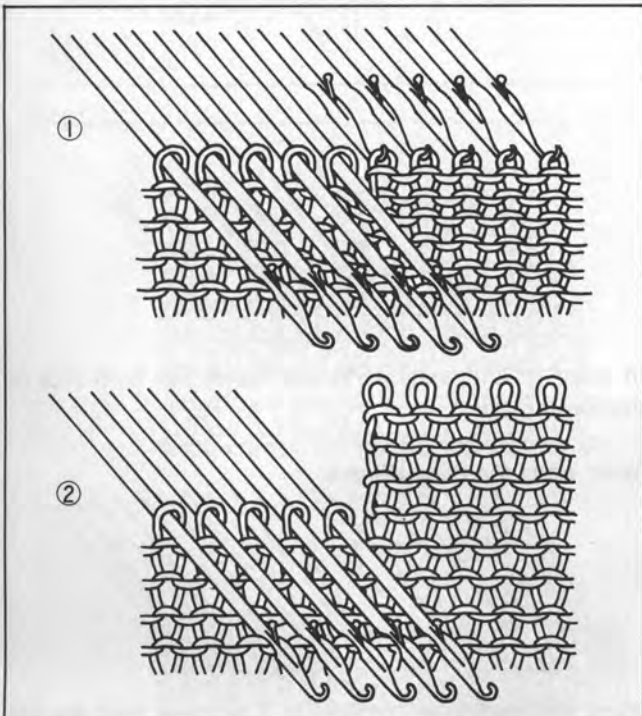

Holding stitches on waste knitting

Set the Cam Lever to A mark and the Russel Lever to the I position.

- ① Leaving the needles in B position for the section to be held, push up the needles to D position.
Thread a waste yarn of contrast colour into the Yarn Feeder, and knit several rows.
- ② Remove the section on the waste knitting from the machine.

To continue knitting for the section remaining on the needles in D position, set the Russel Lever at II (or push back the needles to B position using a Transfer Tool in pattern knitting as shown below).

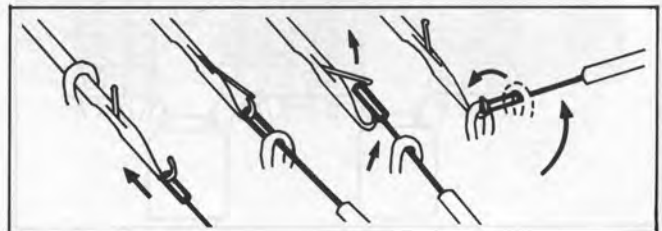

Holding stitches with Ravel Cord

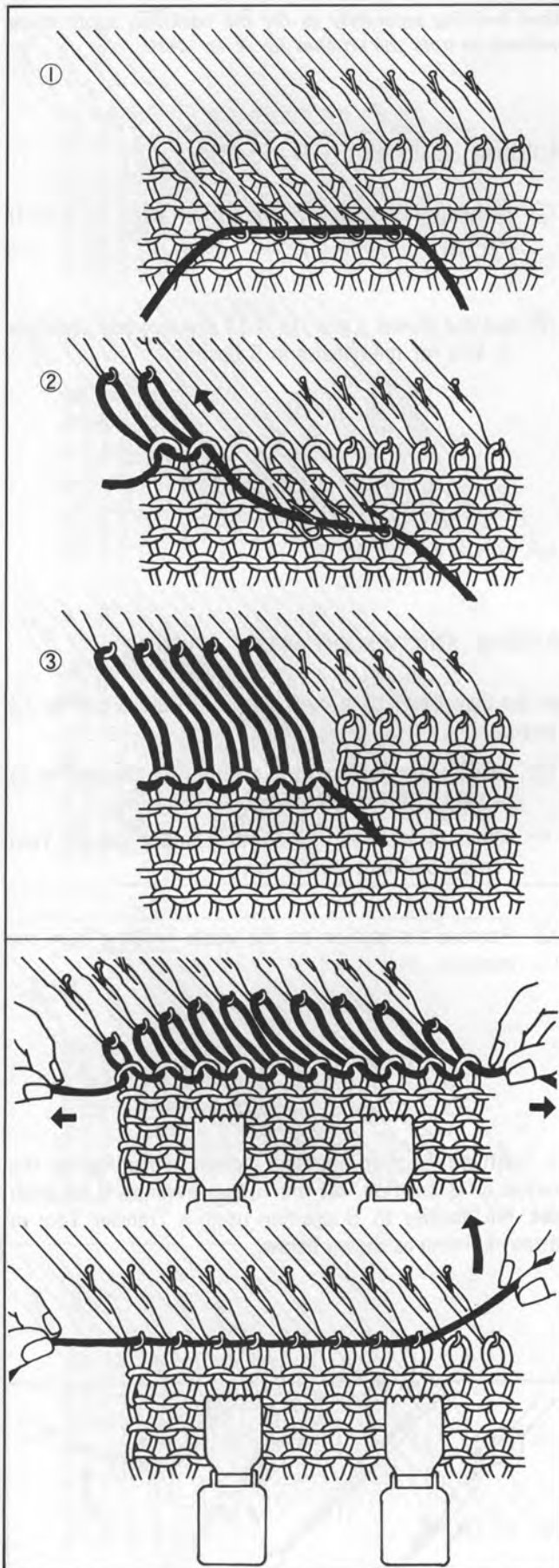

① Push up the needles for the section to be held, to D position, and lay the Ravel Cord across the hooks.

② Starting from the end needle, manually knit the Ravel Cord needle by needle and back to A position.

③ Continue to knit over the needles in B position.

In order to knit again, with both hands pull both ends of the Ravel Cord.

Note: Hang the Claw Weights.

When the needles are brought to B position, hold the left end of the Ravel Cord and pull the other end in an upward motion.

The stitches are replaced in the hooks.

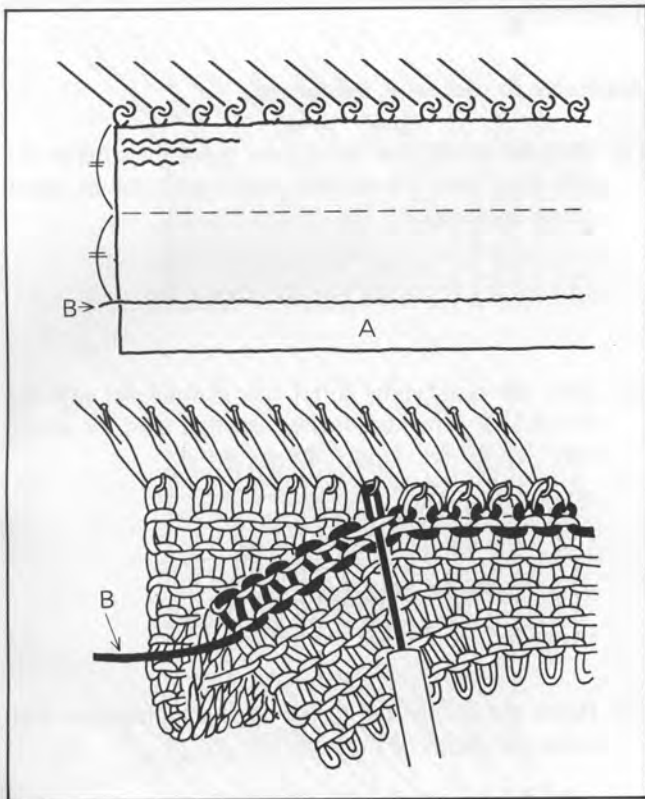

Hemming

- (1) Cast on and knit several rows of waste knitting "A" then knit one row with the Ravel Cord "B".
- (2) With the main yarn, knit twice the depth of the hem.
- (3) Pick up the sinker loops from the first row of the main knitting and place them onto the corresponding needles.
- (4) With the Stitch Dial set 2 numbers higher, knit one row.
- (5) Set the Stitch Dial to the original number and continue to knit.

If the Ravel Cord is pulled out, the waste knitting comes off.

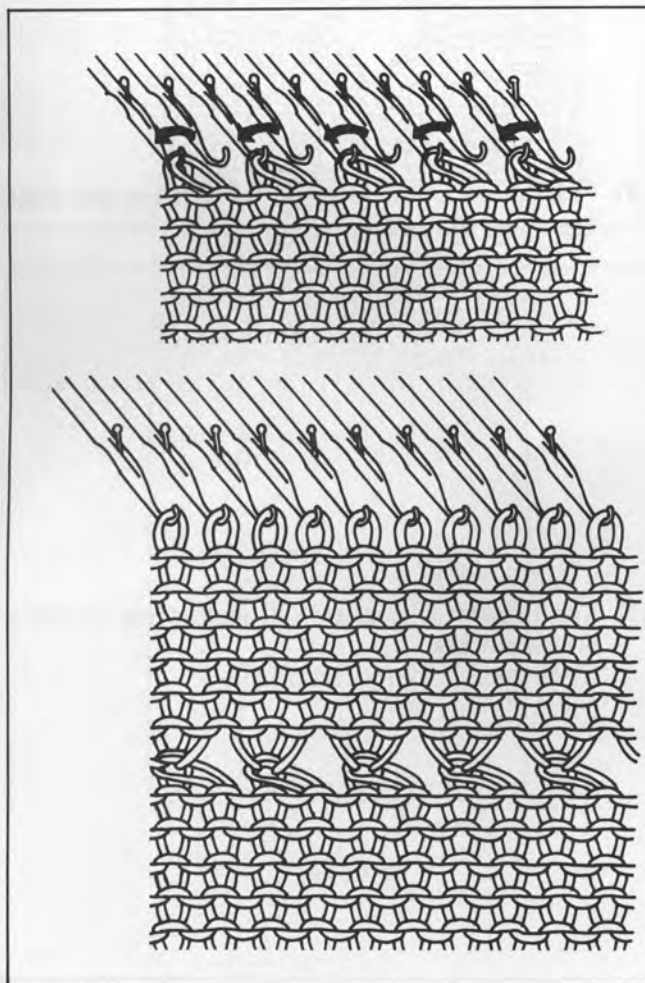

PICOT EDGE

At the folding row, transfer every other stitch onto its adjacent needle.

Note: Align the empty needles in B position, and continue to knit.

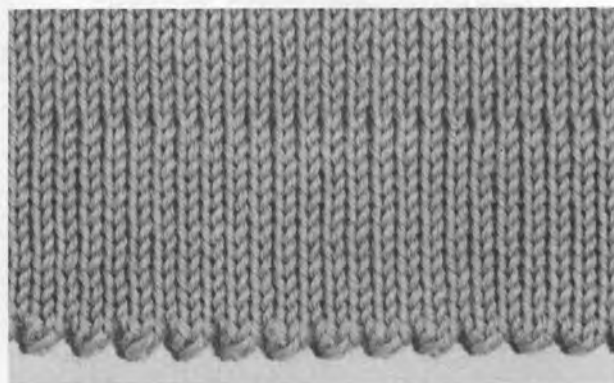

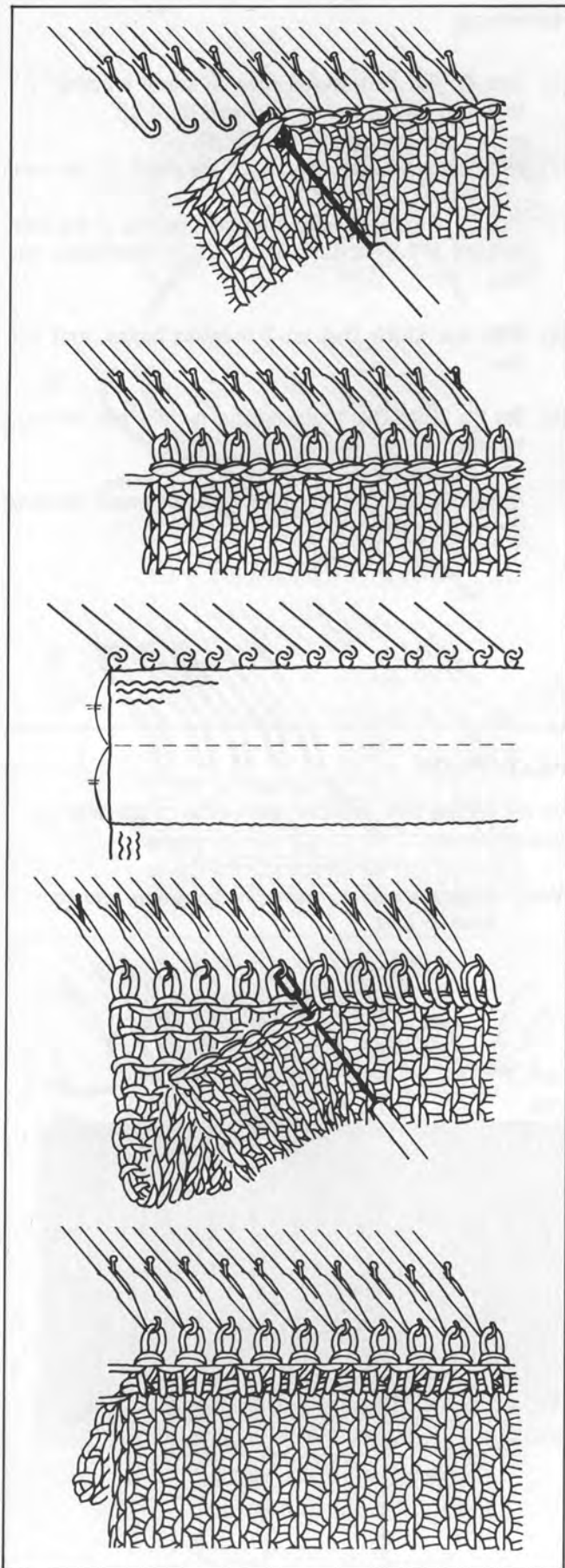

Trimming

Applicable to neckband, border etc.

- (1) With the wrong side facing you, place the stitches of a side edge onto the needles omitting a stitch at appropriate intervals.
- (2) With the main yarn, knit 1 row in stockinet with the Stitch Dial 1 number lower than that used for stockinet.
- (3) Re-set the Stitch Dial to the original number and knit twice the depth of the hem.
- (4) Pick up the sinker loops on the first row and place them onto the needles.
- (5) Knit 1 row for joining, and knit another row for casting off the stitches.
(Refer to page 22 for cast off.)

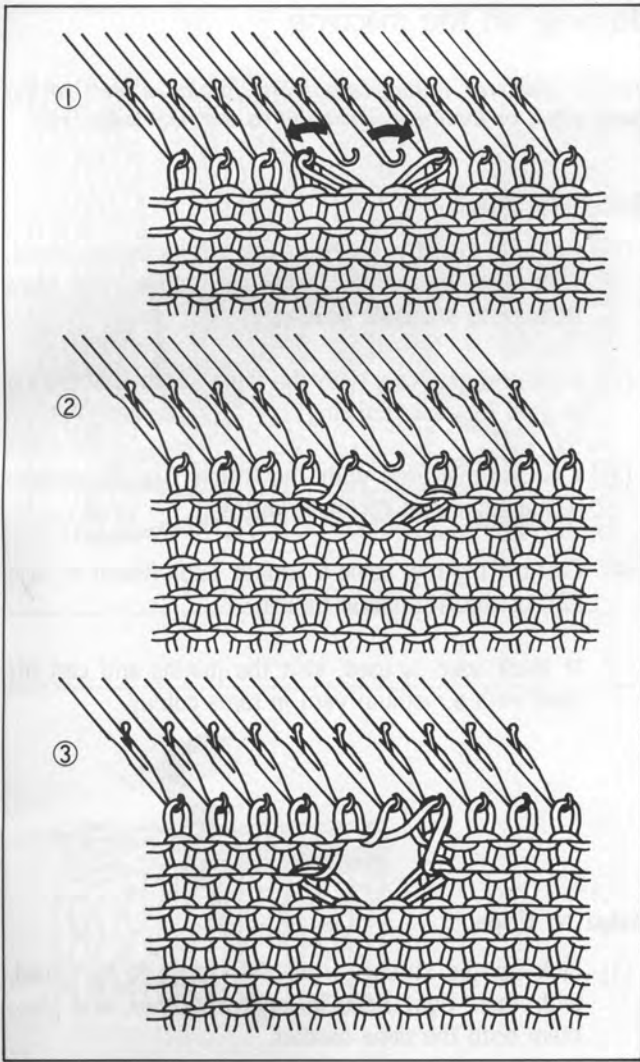

Buttonhole

- ① Transfer 2 stitches onto their adjacent needles respectively.
- ② Knit 1 row and remove the hooked yarn from the right side needle.
- ③ Knit 1 row.
Pick up the yarn crossing above and place it onto the needle.

Continue to knit up to the next buttonhole.

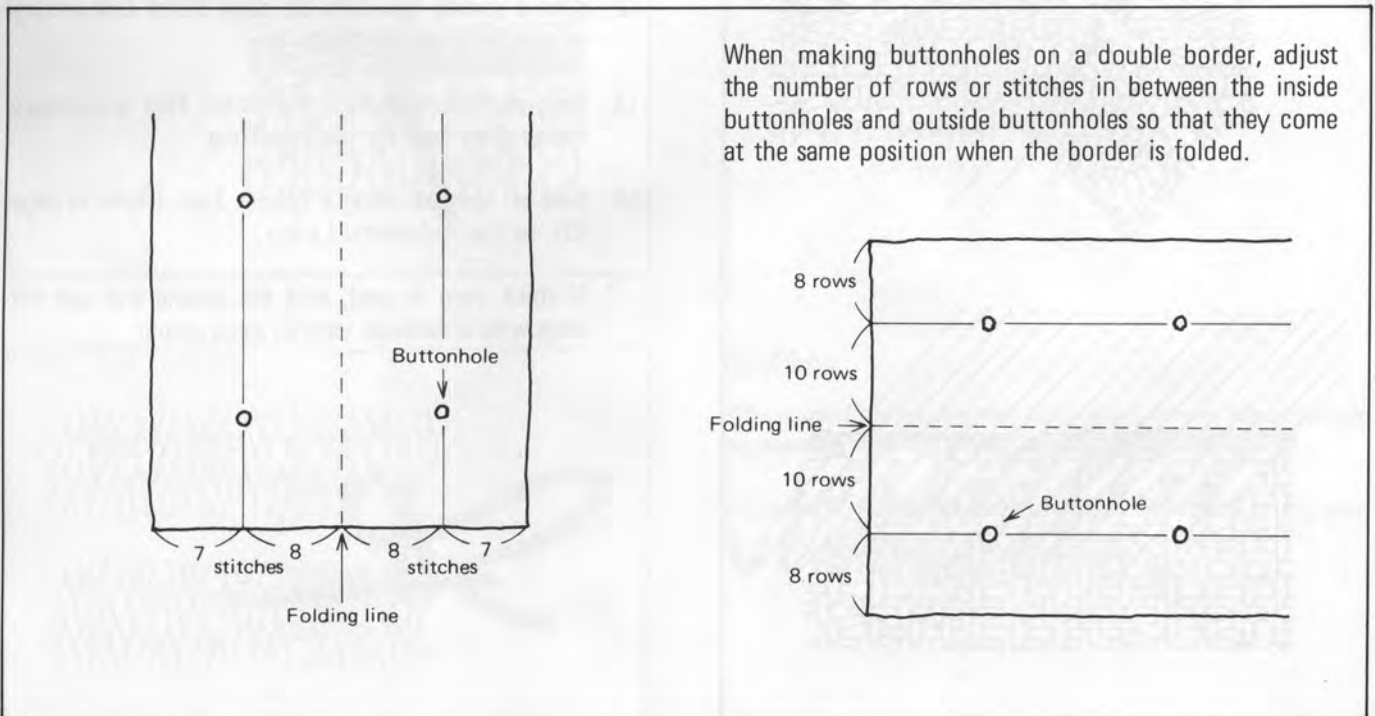

When making buttonholes on a double border, adjust the number of rows or stitches in between the inside buttonholes and outside buttonholes so that they come at the same position when the border is folded.

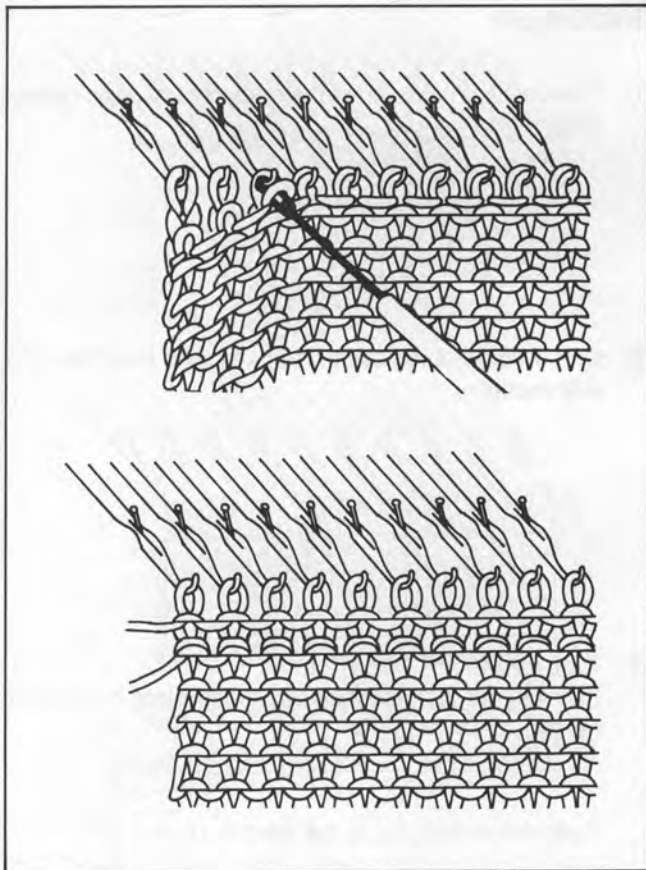

Joining on the machine

This is used for joining shoulders, joining a welt to the waist edge, or joining a neckband to the neck edge, etc.

Stitch to Stitch

- (1) Pick up the stitches from the fabrics to be joined, with their right sides facing each other, and place them onto the same needles.
 - (2) Knit a joining row with the same Stitch Dial setting as used for main knitting.
 - (3) Knit another row with the Stitch Dial 3 numbers higher than used for main knitting.
 - (4) Cast off the row using a Tappet Tool. (Refer to page 22), or the Automatic Linker.
- * If thick yarn is used, knit the joining and cast off rows with a medium yarn in same colour.

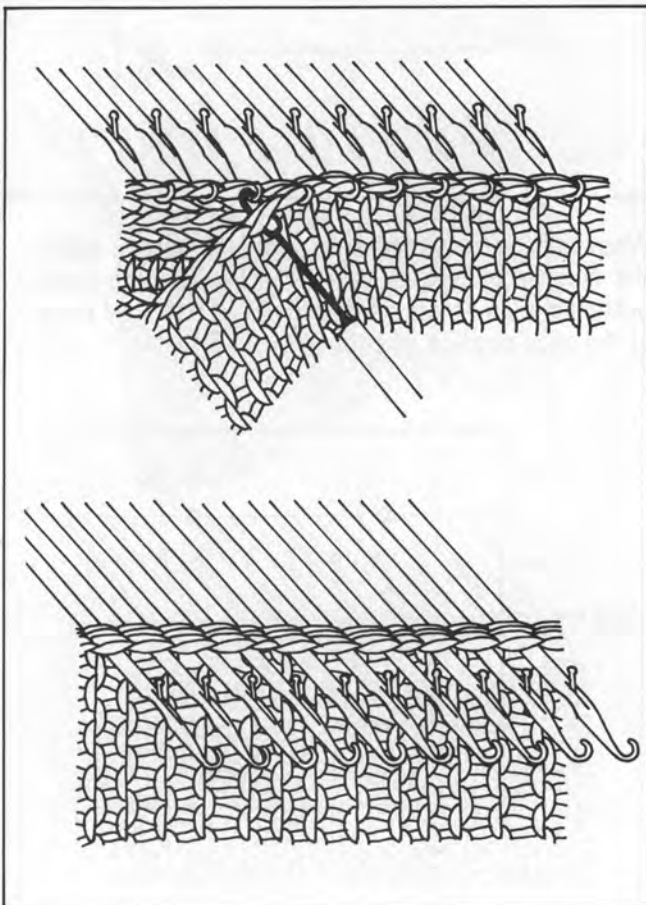

Edge to Edge

- (1) Pick up the stitches from the fabrics to be joined, with their right sides facing each other, and place them onto the same needles.
 - (2) Knit a joining row with the same Stitch Dial setting as used for main knitting.
 - (3) Knit another row with the Stitch Dial 3 numbers higher than used for main knitting.
 - (4) Cast off the row using a Tappet Tool. (Refer to page 22), or the Automatic Linker.
- * If thick yarn is used, knit the joining and cast off rows with a medium yarn in same colour.

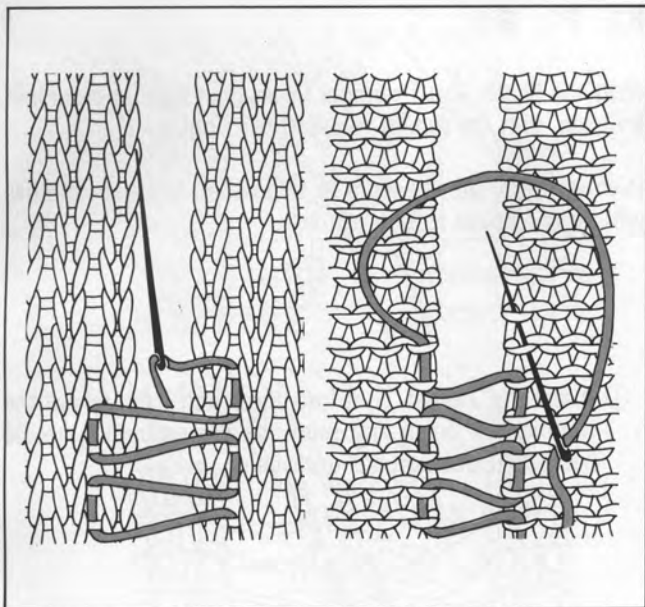

Blind Stitch

This is used for joining side seams.

With the right side of both fabrics facing you, pick up two sinker loops together between the last two stitches from the side edges alternately, as illustrated.

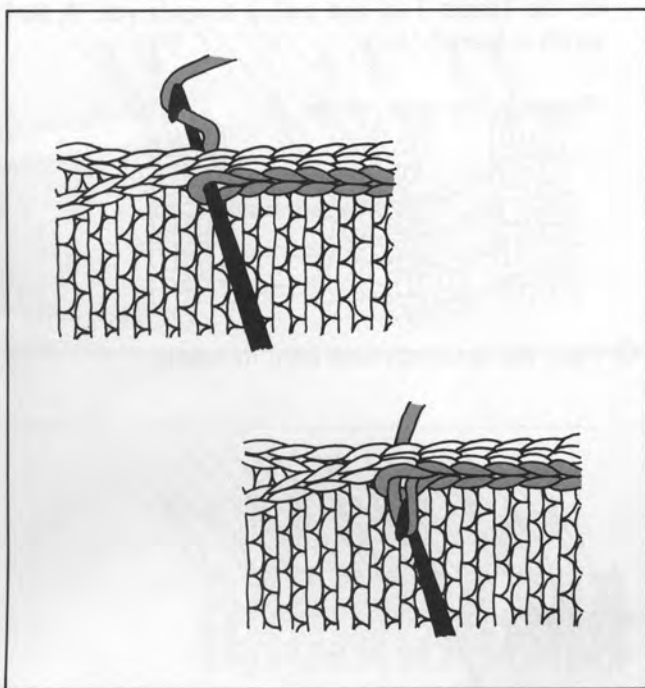

Slip Stitch

This is used for setting in the sleeves or joining side seams.

Place the fabrics to be joined with the right side facing each other. Insert the Crochet Hook into the edge stitches and catch the yarn as shown.

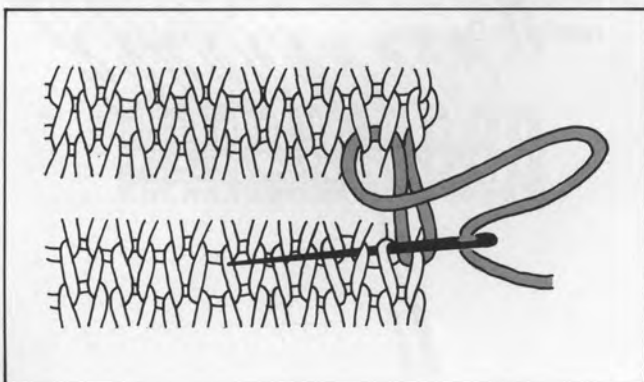

Grafting

This is used for joining two open rows, where ridges formed by seaming should be soft to the touch.

Align both fabrics as shown and thread the knitting yarn through the stitches with the Tapestry Needle.

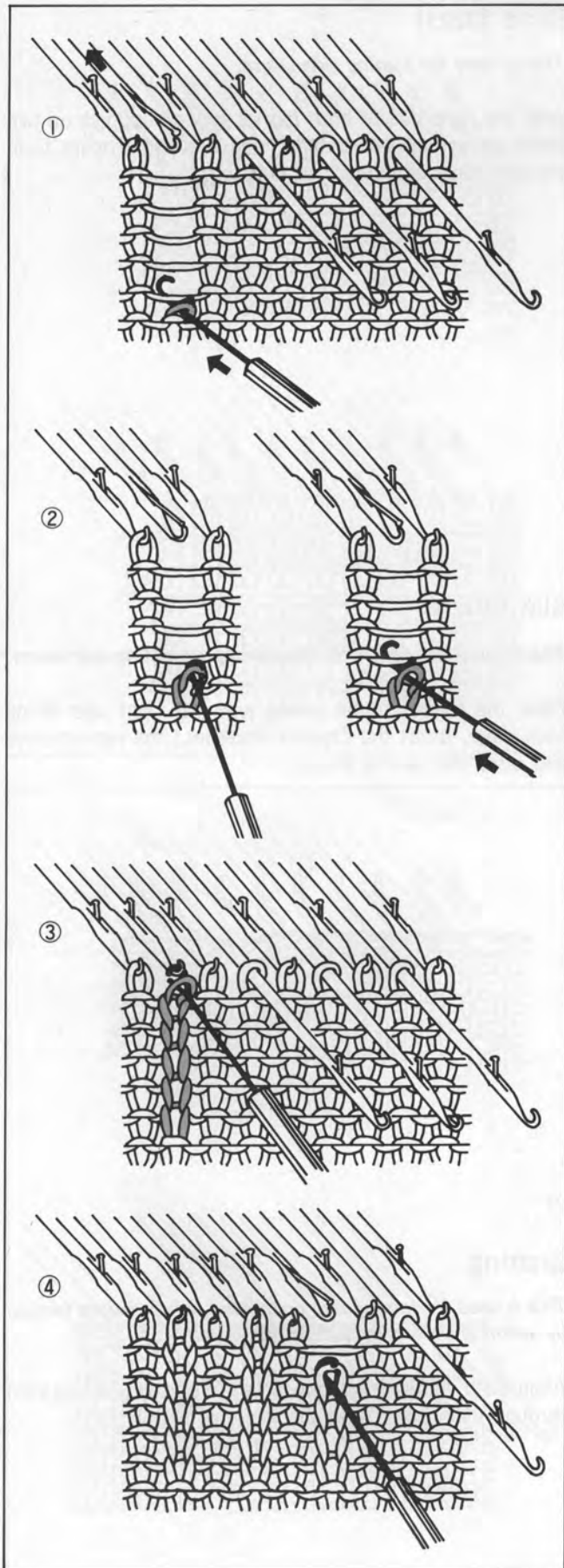

K1. P1. Rib

With the Stitch Dial 1 number lower than that for stockinet knitting, knit the length required for ribbing.

Push up every-other needle to D position of which stitches will be re-formed to purl stitches.

- ① Insert the Tappet Tool into the stitch from where the ribbing will begin and push the corresponding needle back to B position for unravelling.

- ② With the Tappet Tool, hook the yarn above the stitch on the Tappet Tool and pull it towards you. A purl stitch is formed.

Repeat in the same manner.

- ③ Place the last stitch back onto its needle.

- ④ Repeat in the same manner for the stitches held on the needles in D position.

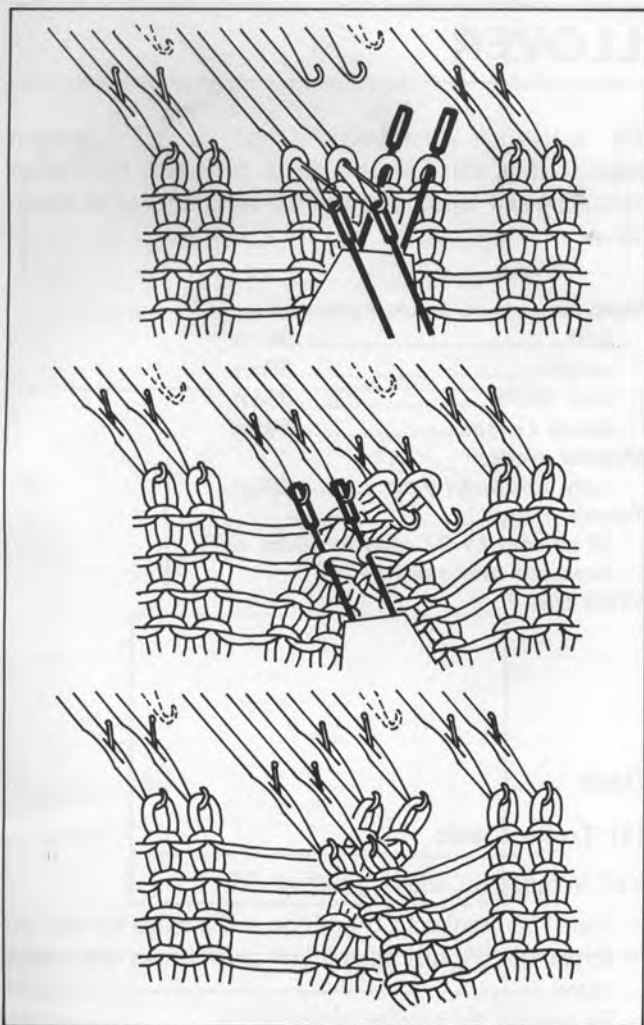

Cable Stitch

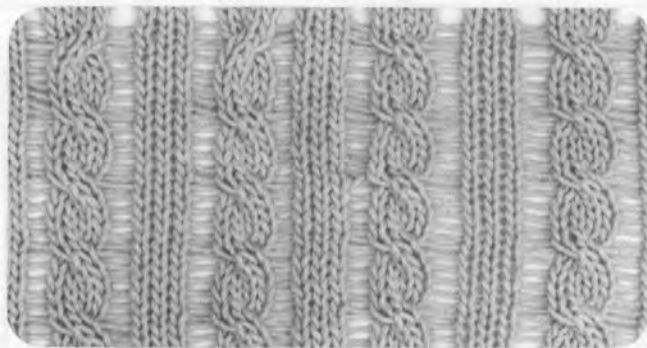

- (1) Transfer stitch on the needles at both edges of the cable pattern to their adjacent needles respectively before starting the cable stitch. Push back the empty needles to A position.
- (2) Using two transfer tools, take two stitches on each transfer tool.
- (3) Cross these stitches and hook the stitches onto the empty needles.
- (4) Pull those 4 needles to D position. Russel Lever at II position and continue to knit.
- (5) Repeat the above method crossing the stitches in the same direction.

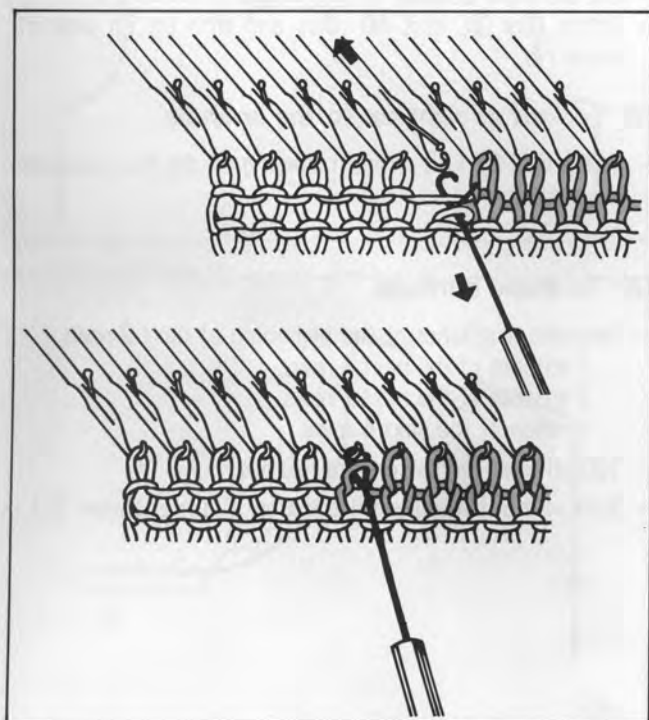

Garter Stitch

Set the Stitch Dial to one number lower than that used for stockinet.

- (1) Knit 2 rows.
- (2) Open the latches of all needles and purl all the stitches on the last row using Tappet Tool.
- (3) Repeat these steps.

LADY'S PULLOVER



The instruction below explains how to knit a garment without using the Knit Contour. A pullover is taken as an example based on the size and the tension gauge as shown below.

Measurements of finished garment.

Bust..... 94cm.
 Length..... 59cm.
 Back Width 36cm.
 Sleeve Length..... 56cm.

Material needed

4-ply (medium) yarn..... 400gs.

Tension Gauge

27 stitches by 37 rows to 10cm. sq.
 measured over stockinet.

Stitch Dial 7

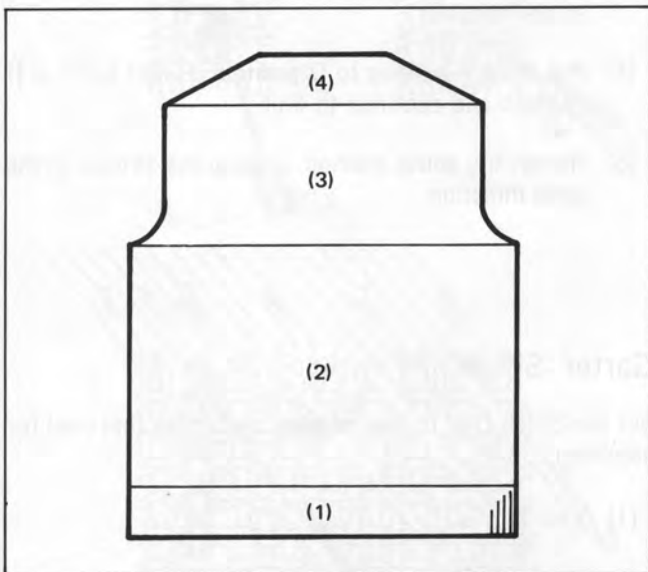

Back

(1) To knit welt

Knit in mock rib referring to page 18.

- Push 128 needles to D position and arrange for cast on.
- Stitch Dial ⑦, cast on and knit several rows with waste yarn.
- Re-arrange the needles for mock rib.
- Knit 1 row with the Ravel Cord.
- Set the Row Counter to 0000.
- Stitch Dial ④, knit 40 rows and turn up for welt of mock rib.

(2) To knit straight up to the armhole

- Stitch Dial ⑦, knit without shaping till the Row Counter shows 160.

(3) To shape armhole

- Decrease 4 stitches at the beginning of next 2 rows,
 3 stitches of the next 4 rows,
 2 stitches of the next 2 rows,
 1 stitch of the next 4 rows.
- 100 stitches remain on the needles.
- Knit without shaping till the Row Counter shows 224.

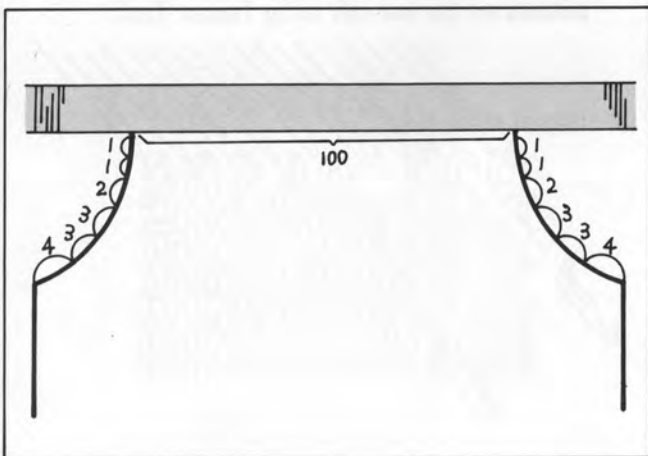

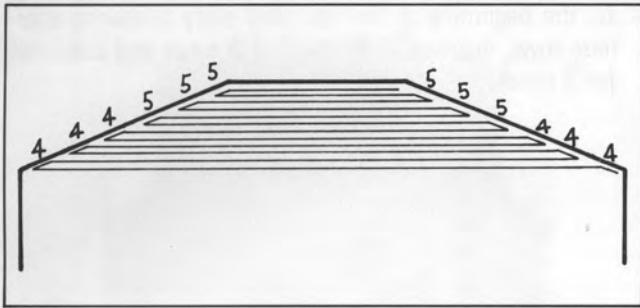

(4) To shape shoulder

- Decrease 4 stitches at the beginning of next 6 rows, 5 stitches of the next 6 rows.
- 46 stitches remain on the needles.
- Stitch Dial ⑩, knit 1 row and cast off. (Refer to page 22.)

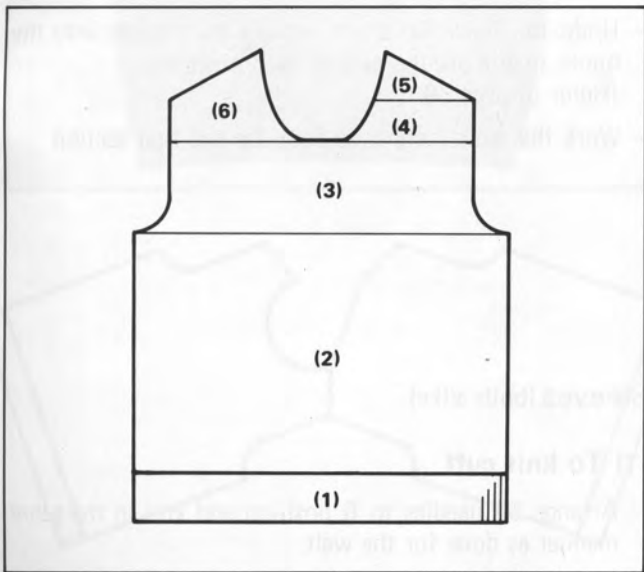

Front

(1)–(3) To knit up to the neckline

- Follow the instructions (1) through (3) for the back till the Row Counter shows 202.

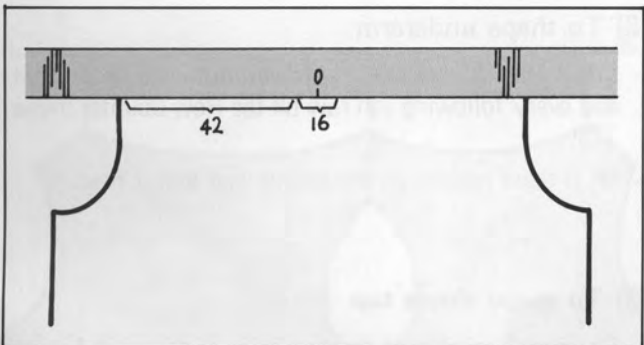

(4) To shape neckline

- Using the same yarn used for knitting, cast off 16 stitches at the centre section by hand. Push back the empty needles to A position.
- For holding 42 stitches on the side opposite the Carriage, knit with the Ravel Cord by hand and push them back to A position one by one. (Refer to page 38.)
- For 42 stitches on the Carriage side, knit 1 row.
- Decrease 4 stitches at the beginning of the next row.
- Knit 1 row and decrease 3 stitches at the beginning of the next row.
- Knit 1 row and decrease 2 stitches at the beginning of the next row and every following alternate row, 2 times in all.
- Knit 1 row and decrease 1 stitch at the beginning of the next row.
- Knit 1 row and decrease 1 stitch at the beginning of the next row and every following 4th row for 3 times. Row Counter 224.

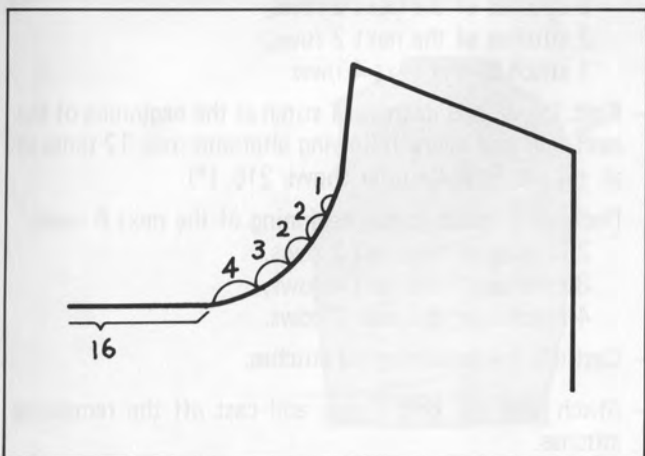

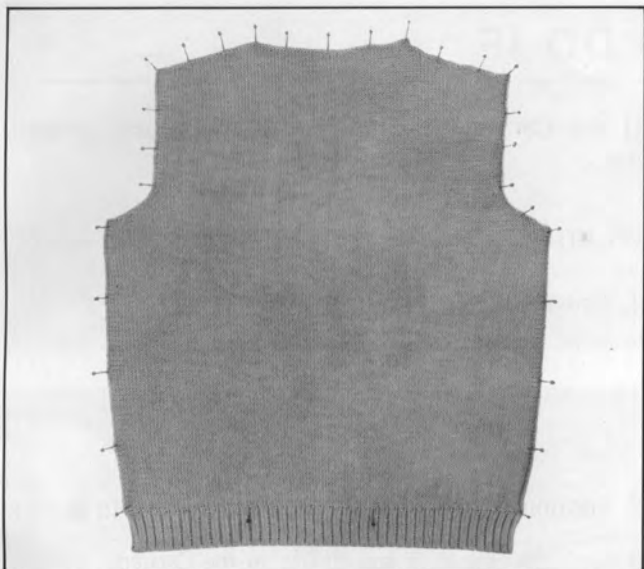

Blocking and pressing

After knitting the pieces of your garments, you must lay them flat and pin them out to their correct shape and size.

Then press them lightly with a warm iron over a damp cloth and leave the pieces to dry before removing the pins.

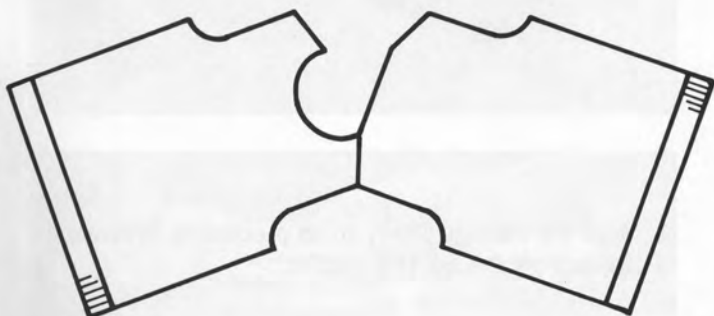

Join the right shoulder

- With the right side of the front facing you, pick up stitches from the right shoulder and place them on the needles.
- With the wrong side of the back facing you, pick up the stitches from the right shoulder and place them on the same needles.
- Stitch Dial ⑦, knit 1 row for joining.
- Stitch Dial ⑩, knit the cast off row.
- Cast off all stitches.

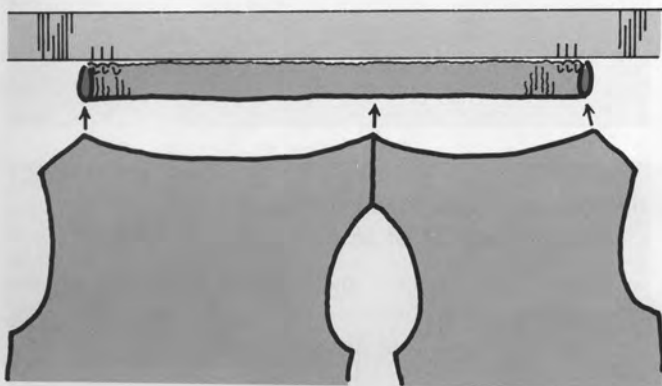

Neckband

- Arrange 128 needles in B position and knit 24 rows in the same manner as done for the welt.
- Pick up stitches from the neck edge with the wrong side facing you.
- Join and cast off in the same manner as done for the right shoulder.

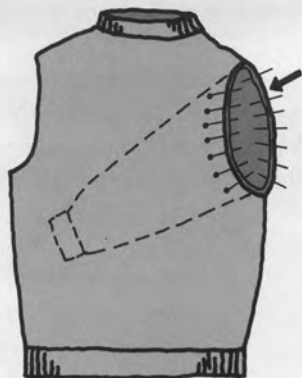

Making up

- (1) Pick up and finish off the left shoulder to correspond with the right shoulder.
- (2) Join the side, neckband and sleeve seams. (Blind stitch – page 43).
- (3) Turn the garment to the wrong side and slip the sleeves into the armhole. Pin them as illustrated and work slip stitch along the edges. (Slip stitch – page 43.)

WHAT TO DO IF

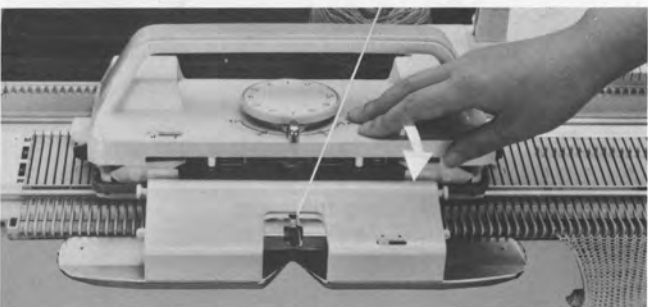
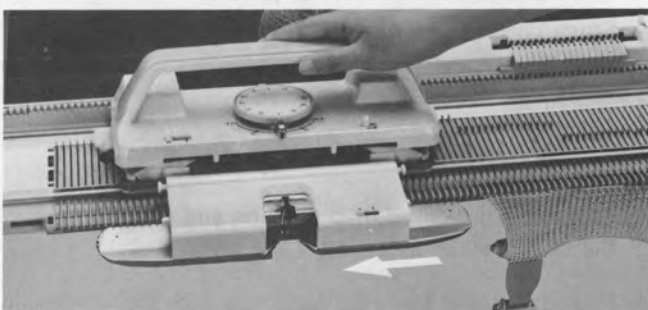
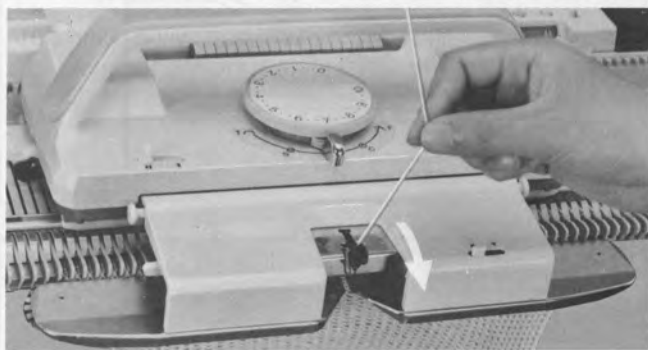

If the Carriage has jammed in the course of knitting...

DO NOT TRY TO MOVE THE CARRIAGE BY FORCE.

1. Remove the yarn from the Yarn Feeder.
2. Position the Set Lever on the Row Counter to ● mark.
3. Push the Release Lever to lift up the Carriage.
4. Move the Carriage slowly to its proceeding direction till it clears off the working needles.

5. Pick up dropped stitches, if any.
(Refer to page 54 or 55 for correcting a stitch)

Unravel the incomplete row, and pass the Carriage to the side of the yarn end.

(Refer to page 57 for unravelling the row.)

If a Punch Card has been in use, refer to page 53 for correcting the pattern memory.

6. Replace the yarn into the Yarn Feeder, adjust the Row Counter and set its Lever to ▼ mark, press down the front edge of the Carriage to close it, and knit.

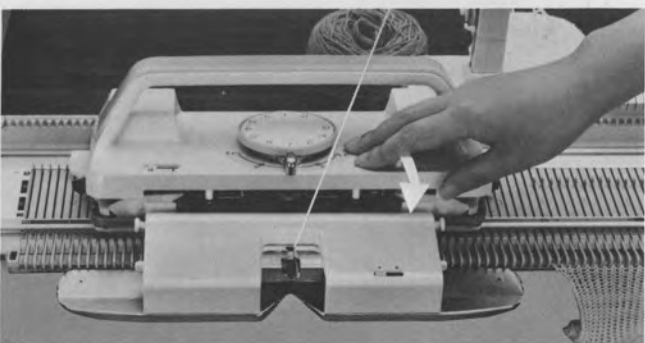
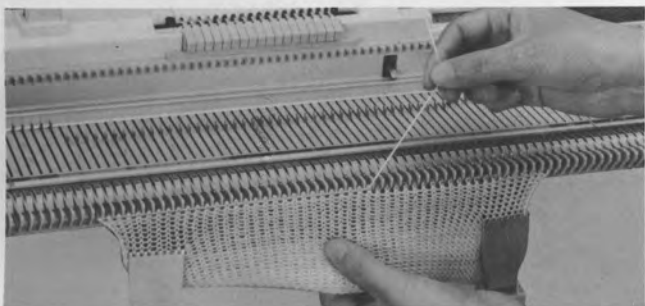
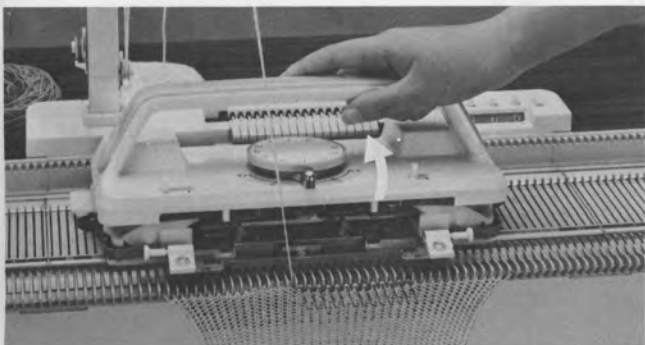
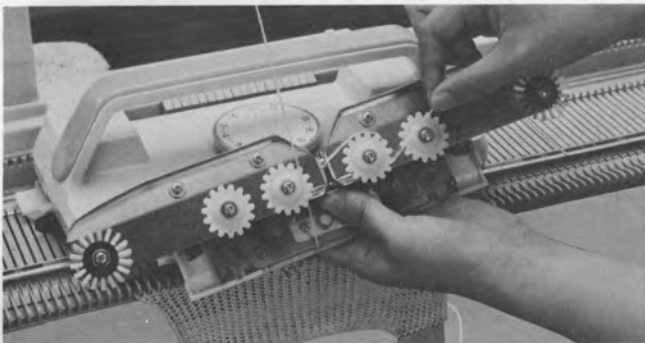
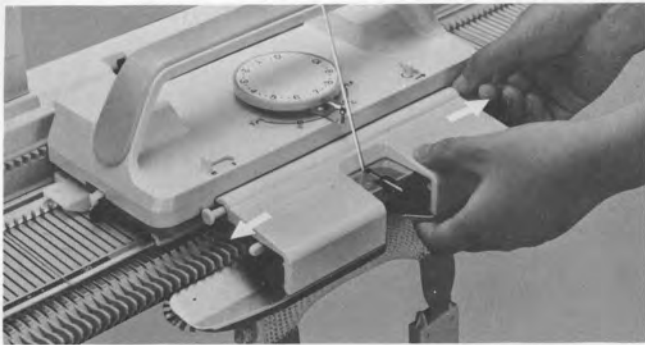

If a yarn has entangled into brushes on the Presser...

1. Holding the Arm with your hand, pull out the Arm Coupling Pins, one by one, and draw the Arm towards you.

2. Remove all the entangled yarn from the gears or brushes on the Pressers.

DO NOT PULL THE YARN FORCEFULLY.

3. Position the Set Lever on the Row Counter to ● mark.

4. Lift up the Carriage by pushing the Release Lever, and move the Carriage to its proceeding direction till it clears off the working needles.

5. Pick up dropped stitches, if any.
(Refer to page 54 or 55 for correcting stitches.)

Unravel the incomplete row, and pass the Carriage to the side of the yarn end.
(Refer to page 57 for unravelling the row.)

If a Punch Card has been in use, refer to page 53 for correcting the pattern memory.

6. Press down the front edge of the Carriage to close it. Replace the Arm on the Carriage.

7. Replace the yarn into the Yarn Feeder, adjust the Row Counter and set its Lever to ▼ mark, and knit.

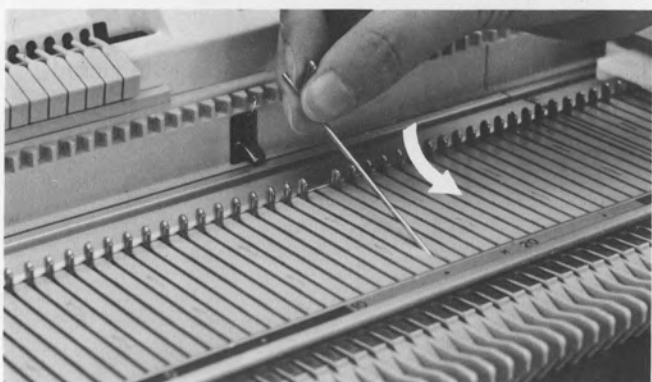
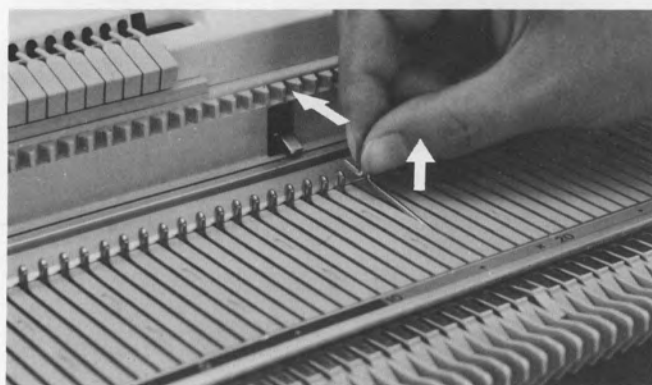
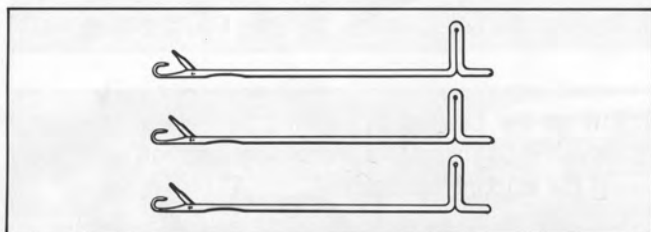
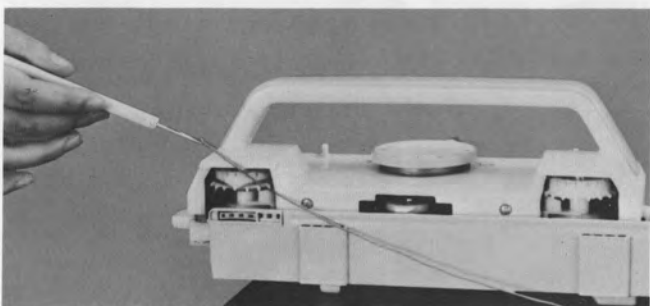
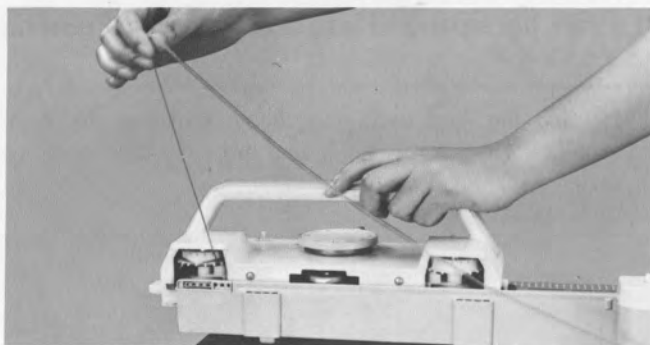

If a yarn has been entangled into the Carriage...

DO NOT PULL OUT THE ENTANGLED YARN BY FORCE.

By turning the Gear on the back of the Carriage slowly, and disentangle the yarn with care.

Or it is practical to use a Tappet Tool to remove the yarn from the Carriage.

If you apply force to remove the entangled yarn, you will damage the parts inside the Carriage.

If a needle has been damaged...

Three needles for replacement are included with the machine.

1. Push the damaged needle to B position.
2. Hold the needle butt, and lift it up and guide it through backward.
3. In the same slot, fit a hook of a new needle and thrust it forward.

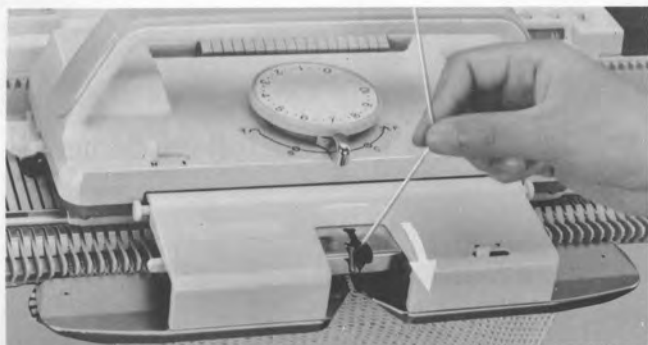

If you have made a mistake in knitting...

1. Remove the yarn from the Yarn Feeder, and move the Carriage out of the knitting needles by operating the Release Lever.
2. Unravel the incomplete and incorrect rows.
3. Readjust the Row Counter and set its Set Lever to ● mark.

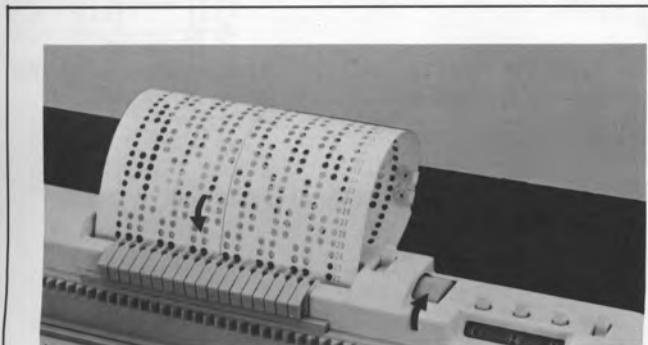

In Pattern Knitting

If a Punch Card is being in use, carry out the following additional steps.

Return the Punch Card as many rows as the rows unravelled, and lock it by setting the Card Lever at ● mark.

Lift up the Carriage, by pushing the Release Lever, and pass the Carriage in front of the Punch Card.



4. By operating the Release Lever, pass the Carriage over to the side of the yarn end.
5. Replace the yarn into the Yarn Feeder, press down the front edge of the Carriage to close the Carriage, and set the Row Counter Set Lever to ▼ mark.
Release the Punch Card, if it is in use.
Continue to knit.

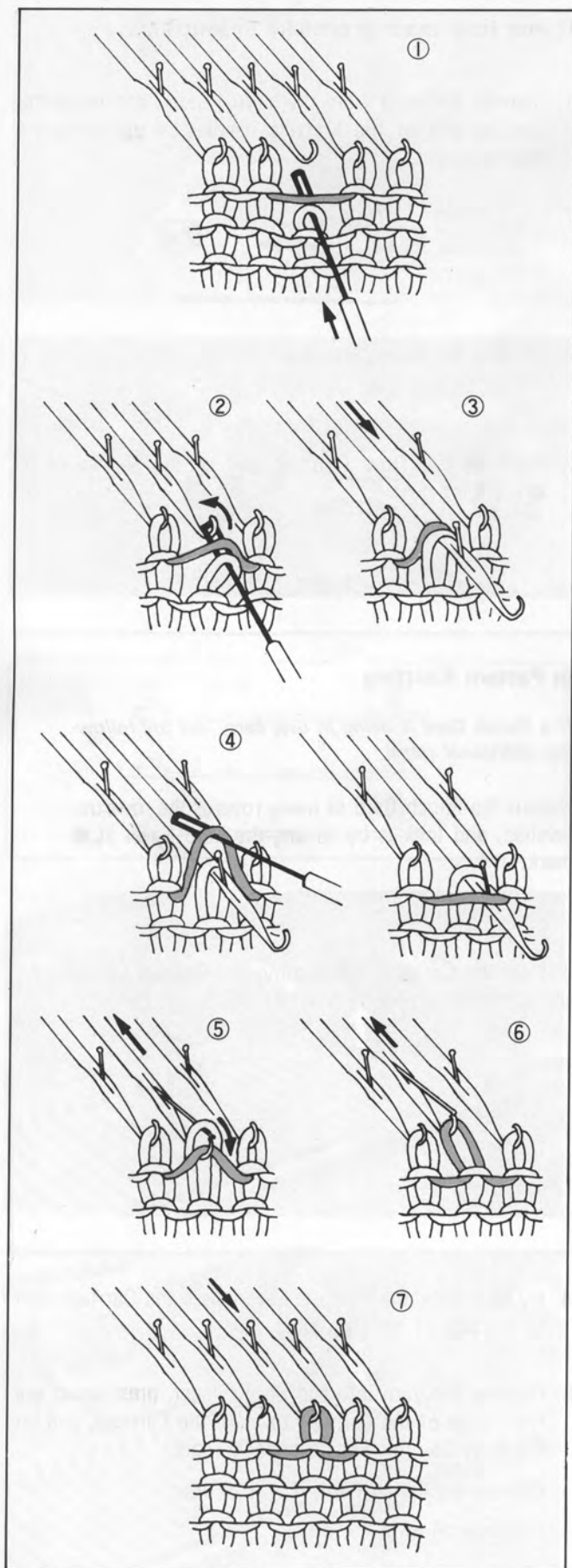

If a stitch has dropped...

- ① Insert a prong of a Transfer Tool into the dropped stitch.
- ② Replace the stitch onto the empty needle together with the bar above the stitch.
- ③ Push forward the needle till both stitches move behind the latch.
- ④ Lift up the bar using the Transfer Tool and bring it over the latch.
- ⑤ Push back the needle till the stitch behind the latch slips off of the needle.
- ⑥ Push the needles toward A position to correct the size of the stitch.
- ⑦ Align the needle correctly in B position.

If a dropped stitch has run down for several rows...

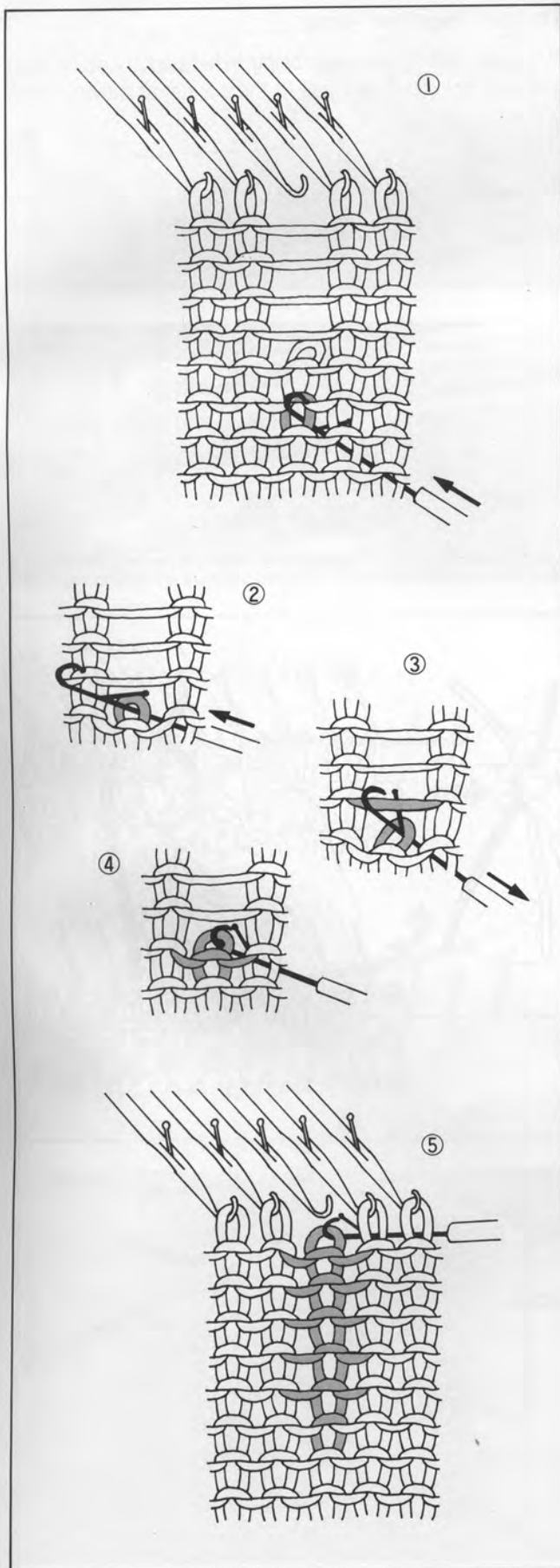

- ① Insert the Tappet Tool into the stitch at a few rows down the dropped stitch from the rear side.
Let the stitch run down to the Tappet Tool.
- ② Push forward the Tool till the stitch moves over the latch of the Tool.
- ③ Pulling the Tool backward, catch the bar crossing above.
- ④ The stitch behind the latch slips off of the Tool and interloop with the bar in the hook.
- ⑤ Repeat the above steps up to the top stitch.
- ⑥ Take the top stitch onto the Transfer Tool on the front side, and fill the empty needle with it.

If one or more stitches have dropped or when pattern knitting using the Punch Card, it would be rather easier to unravel the rows than to repair the stitches.

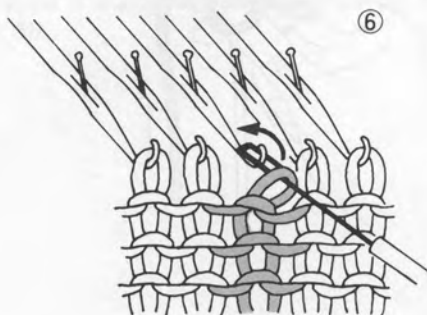

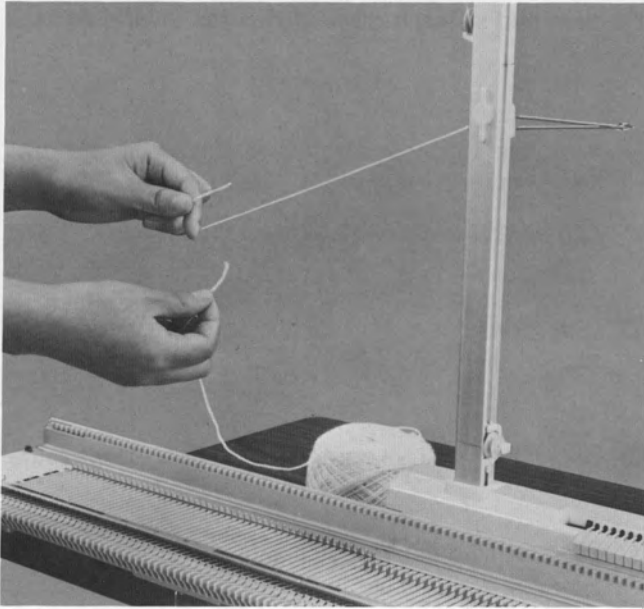

To knot together yarns

If a yarn ball comes near being exhausted, knot its yarn end with the next yarn ball in the manner as shown below.

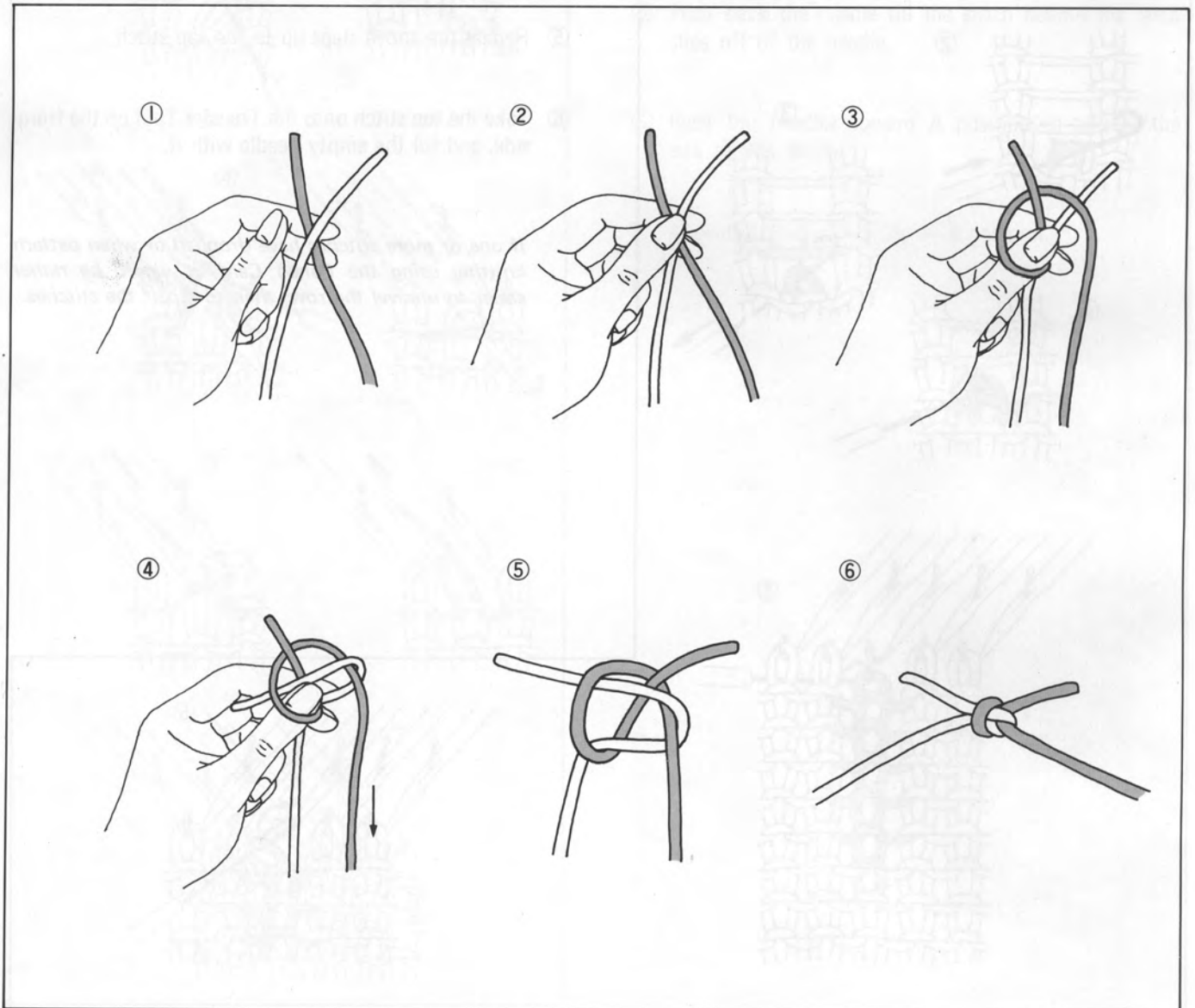

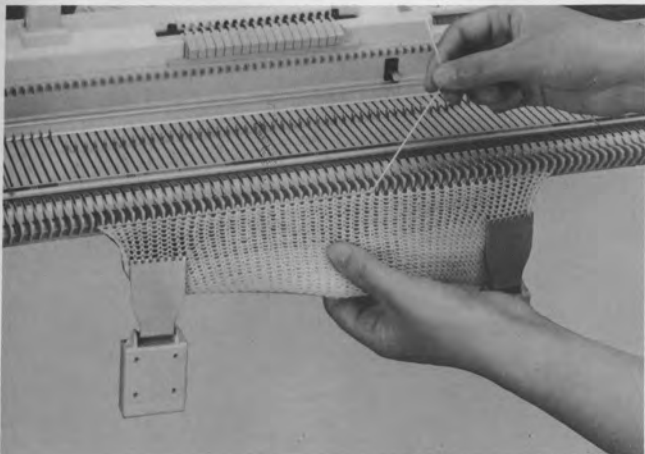
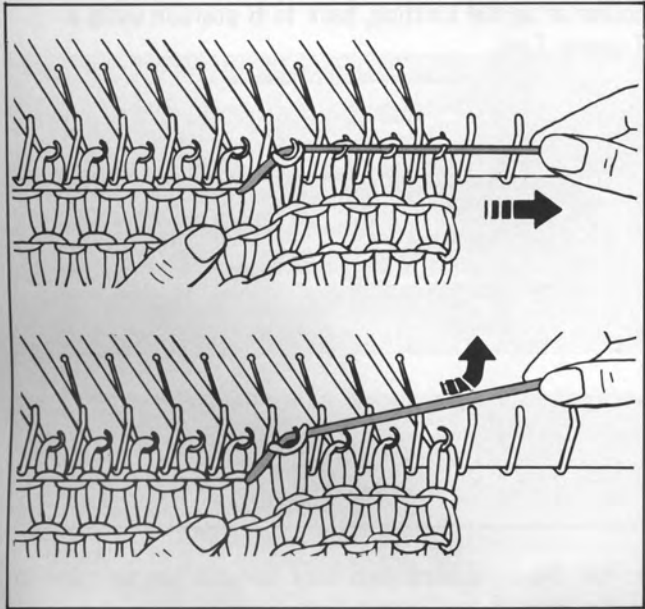
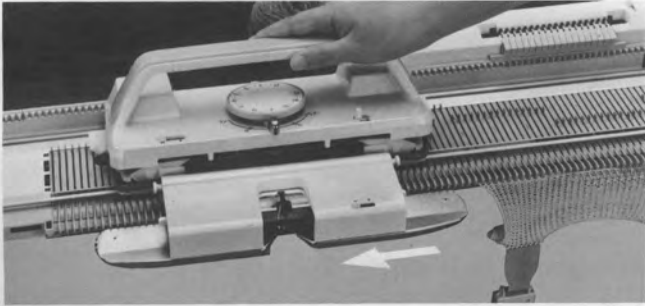
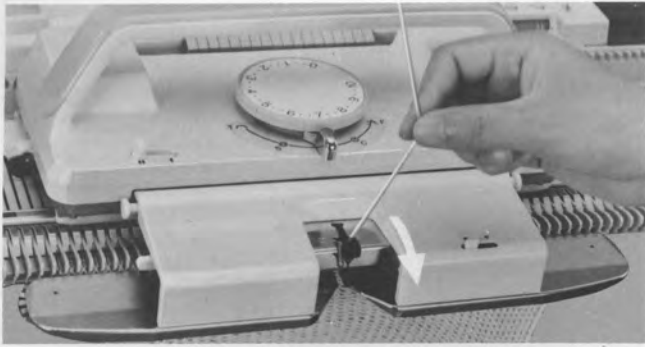

To unravel knitted fabric on the machine.

1. Remove the yarn from the Yarn Feeder.

2. By operating the Release Lever, lift up the Carriage and move it out of the knitting needles.

Hang the weights near the top of the fabric.

3. Unravel the rows in the following manner.

Holding the fabric downwards, pull the yarn out, and the row gets tight.

Lift the yarn upwards and very slightly backwards, the stitches of the previous row will slide off the yarn and back into the needle hooks.

If the fabric is shaped in decrease or partial knitting, refer to page 58.

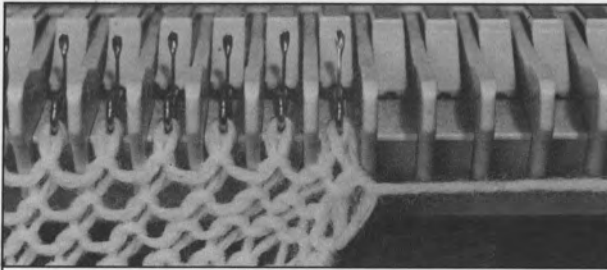

Fabric with decreased edge

On the row of decrease, the end needle has two stitches, place one stitch back to its original needle.

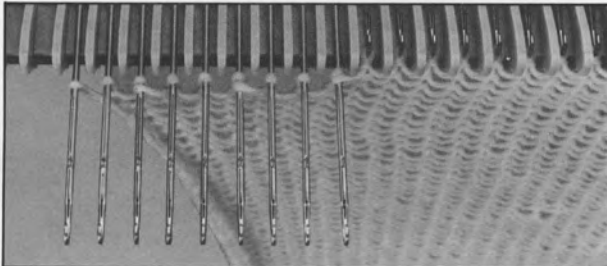
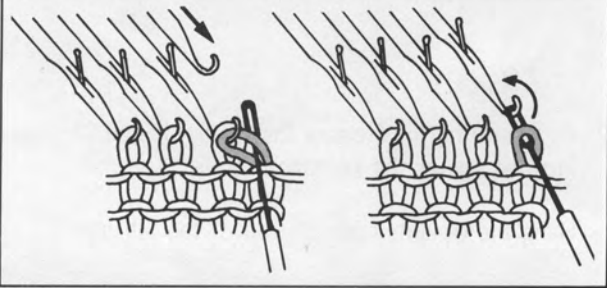

In the course of partial knitting

Push the needles, pushed out to D position in the course of partial knitting, back to B position using a Transfer Tool.

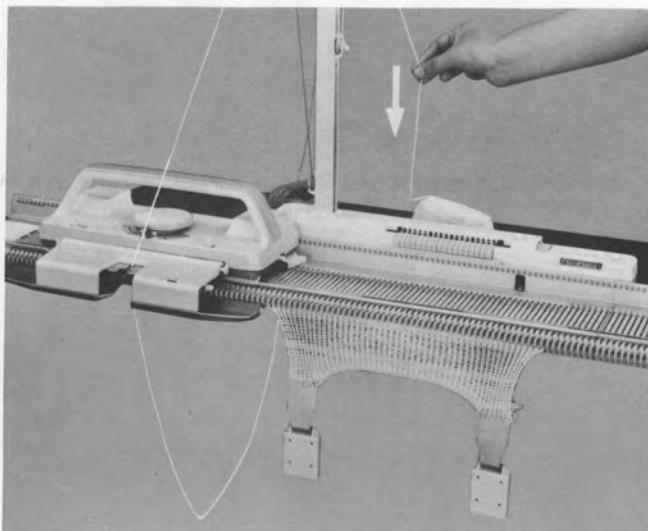
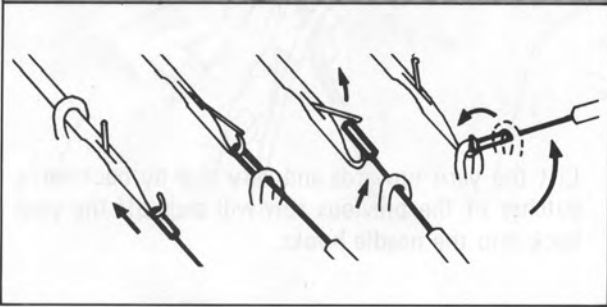

4. Pull the unravelled yarn back towards the yarn ball at the back of the Tension Post.

To continue knitting, pass the Carriage over to the side of the yarn end, adjust the Row Counter, and replace the yarn in the Yarn Feeder.

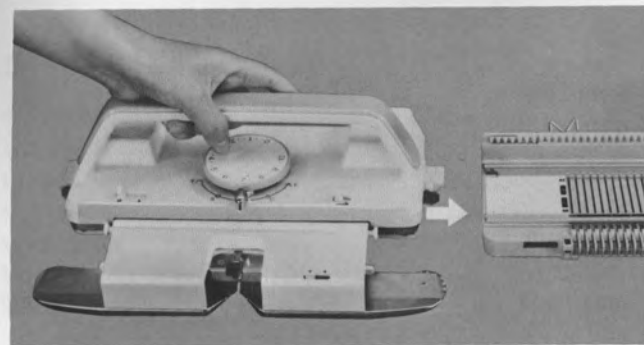
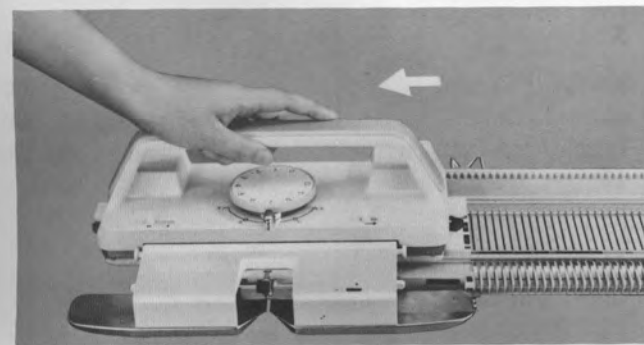
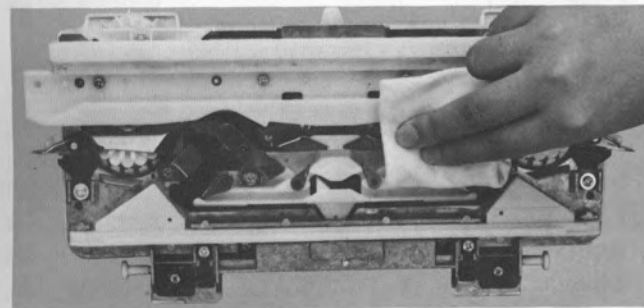
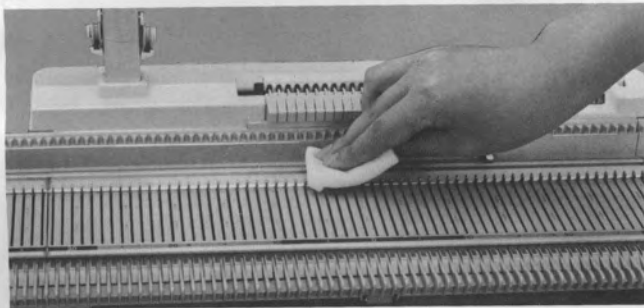
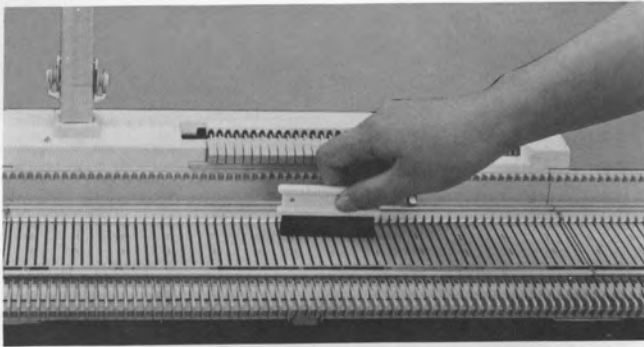

To remove the Carriage from the Needle Bed

In order to clean or lubricate the bottom of the Carriage, you have to remove the Carriage from the Needle Bed.

Bring the Carriage to the left side of the needle bed, and push it off while holding it upwards.

To replace the Carriage on the needle bed, fit it at the left side of the needle bed, and push it in.

To keep the machine in proper condition

Clean the machine using the Brush.

Apply oil over the sliding part of the machine with oil damped cloth.

- Over the rear of the needle bed.
- Over the front of the Needle bed.

- Sliding part on the bottom of the Carriage.

INDEX

- A**
- accessory box 2
 - adjacent needle 34
 - Arm. 2
 - Arm Coupling Pin 6, 51
 - armhole 46
 - Arm Lever 4, 6
 - Automatic Linker. 42
 - Auto Tension 4, 6, 18
- B**
- book pocket 1
 - Blocking. 49
 - Bust 12
 - butt 12
 - buttonhole 41
- C**
- cable pattern 45
 - Cam Lever 6, 11, 13, 23
 - Card Dial 6, 24
 - Card Lever 6, 11, 13, 23
 - Card Memory Number 23, 24, 26
 - Card Setting Lines 23
 - Card Snap. 7, 24
 - Carriage 4
 - Carriage direction. 23
 - case cover. 1, 5
 - cast off 18
 - cast off row 22
 - cast on. 18
 - Cast on Lever 6, 13, 15, 20
 - Center Line. 23
 - Clamp 2, 3, 7
 - Clamp receivers 3
 - clamp screw grip 16
 - Claw Weight 7, 15, 25
 - Cleaning Brush 7
 - Clip 16, 26
 - contrast yarn. 26
 - cord. 11
 - Crochet Hook 3, 4, 7
 - cuff. 48
- D**
- damp cloth. 33
 - decrease 18
 - double border 41
 - dropped stitch. 51
- E**
- empty needle 34
 - end needle 38
 - entangled yarn. 51
- F**
- Fabric Presser 14
 - Feeding Holes 23
- G**
- Garter Stitch. 45
 - Gauge Scale 7, 31, 33
 - gear 52
 - ground yarn 26
- H**
- holding stitch 37
 - hook 12
 - hooked yarn 41
- I**
- Increase 18
 - Inserting Direction 23
 - inside buttonhole. 41
- K**
- Knit-in (Fair Isle). 11, 26
 - knitting needle. 53
 - knob of the Cam Lever. 11
- L**
- latch 12, 45
 - latch needle 12
- M**
- main knitting 42
 - material 46
 - mock rib 18
- N**
- neck band 42

neck edge	42
neckline	47
Needle Bed	13
needle hook	5, 7, 21
Needle Pusher	4, 7, 13, 18

O

oil	7
open rows	43
original needle	58
original number	40
Operation Table	23, 26
outside buttonhole	41

P

partial knitting	26
partial knitting	
— by decreasing stitches	35
— by increasing stitches	36
pattern knitting	35
pattern memory	51
picot edge	39
Pulley Guide	9
Punch Card	7, 24
Punch Card Slit	6
purl stitch	44

R

Ravel Cord	7, 18
Red Button (Lock Lever Button)	5
Release Lever	6, 50
ribbing	44
ridges	43
Row Counter	6, 13, 16
Row (Vertical)	33
ruler-like object	22
Russel Lever	6, 12, 23

S

selected needle	26
Set Lever	6, 13
shoulder	47
side seams	43
sinker loop	3, 9, 40, 43
Skein Holder	8
Slack Adjuster	9

sleeve top	48
slip	11
Snapping Holes	23
Spare Needle	7
steam iron	22
Stitch Dial	6, 10, 13
Stitch Dial Number	10
stitch (Horizontal)	33
stitch type	31
stockinet	35
STOCKINET (PLAIN STITCH)	11

T

Tapestry Needle	7, 43
Tappet Tool	7, 22
Tension Disc	9
tension gauge	31, 33
Tension Guide	9
Tension Lever	9
Tension Post	2, 4, 15
Tension Pulley	9
tension swatch	31
Transfer Tool	7, 19
transparent box	1
Tuck	11

U

underarm	48
unravelled yarn	58
unravelling	44
utility box	5

W

waist edge	42
waste knitting	37, 39
waste yarn	37
welt	42
working needle	51

Y

yarn ball	1
Yarn Ball Winder	8
Yarn Clip	9, 19
Yarn Feeder	6, 14, 21, 23
Yarn Feeder Gate	14
Yarn Guide	2, 4, 9
Yarn Rest	7, 16

