

CB-2710, CB-2720 / TC3

パーツブック
PARTS BOOK

電磁式テープカッター装置 (TC-3 装置)

SOLENOID-TYPE TAPE CUTTER

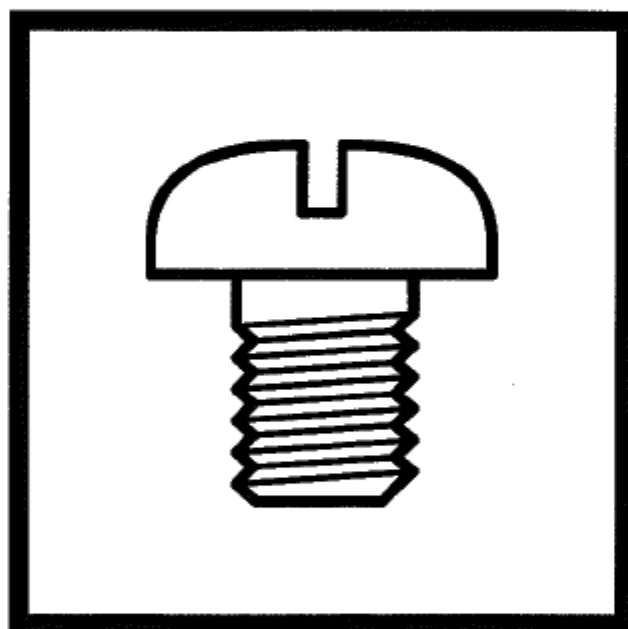

パーツブックご利用に際して

1. 部品コード欄、記事欄が*となっている場合は（5 ページ）の仕様別部品一覧表でお調べ下さい。
2. この本は1988年4月のデータにもとづいて作成されたものです。
3. 部品は予告なしに設計変更される場合があります。

目 次

A. テープカッター電磁関係.....	1
B. T.CコントロールBOX 関係	3
仕様別部品一覧表.....	5
索 引.....	6
ゲージ部品.....	7

Notes for using this parts book

1. If the parts code column is marked with an asterisk (*), see page 5 for the different parts list.
2. This parts book is based on data current as of April 1988.
3. Parts are subject to redesign and modification without prior notice.

CONTENTS

A. Tape cutter solenoid mechanism	1
B. Tape cutter controller box mechanism	3
DIFFERENT PARTS LIST	5
INDEX	6
GAUGE PARTS LIST	7

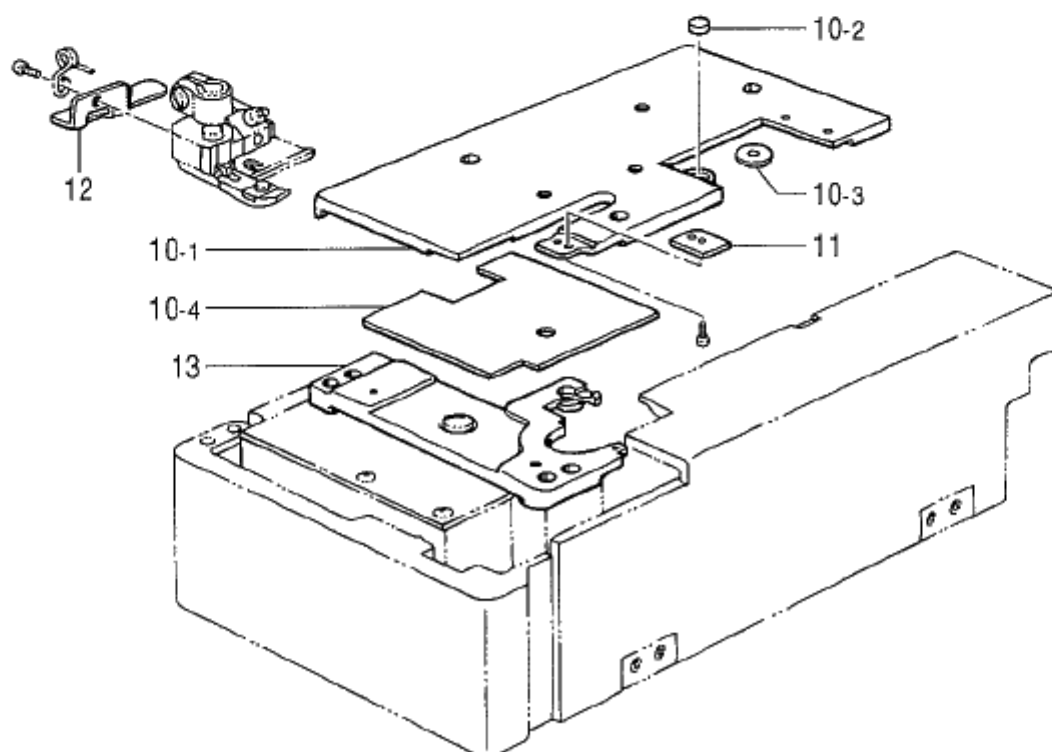
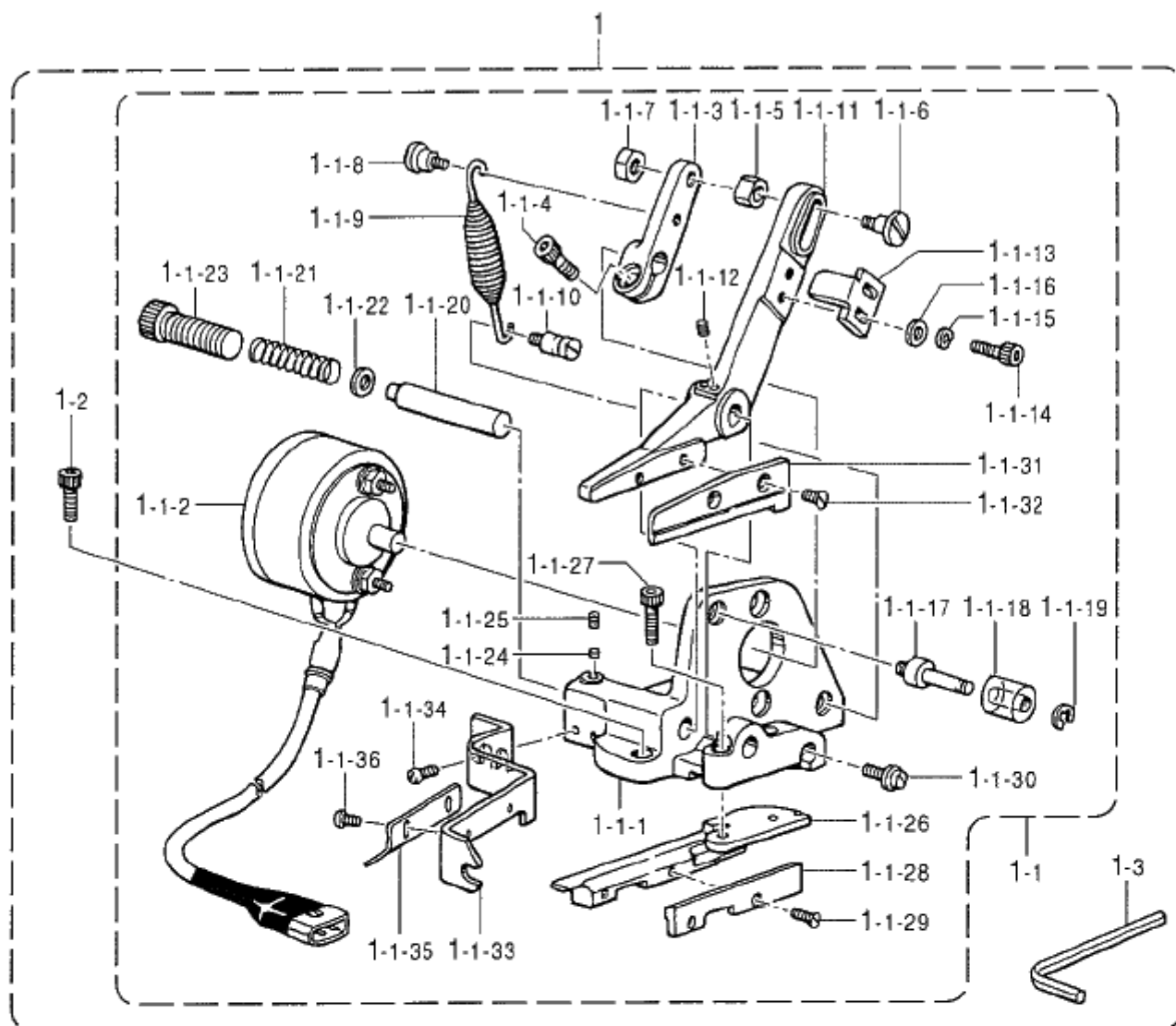

REF.NO.	CODE	Q'TY	ヒンメイ	NAME OF PARTS	RMKS
1	S11631001	1	テープカッターデ"ンシ"クミ	TAPE CUTTER SOLENOID ASSEMBLY	
1-1	S11612001	1	T.Cデ"ンシ"ソウチクミ	TAPE CUTTER SOLENOID DEVICE	
1-1-1	S11613001	1	ソレノイド"ト"ダイ	SOLENOID BASE	
1-1-2	S11614001	1	テープカッターソレノイド"	TAPE CUTTER SOLENOID	
1-1-3	S11615001	1	カッタークト"ウレハ"	CUTTER DRIVING LEVER	
1-1-4	018771432	1	アナボ"ルト635-40X14	BOLT 6.35X14	
1-1-5	S11616001	1	カクゴ"マ	SLIDE BLOCK	
1-1-6	155558001	1	タ"ンネシ"6.35	STUD SCREW 6.35	
1-1-7	150555001	1	ナツ"6.35	NUT 6.35	
1-1-8	151987001	1	タ"ンネシ"4.37	STUD SCREW 4.37	
1-1-9	S11617001	1	モト"シハ"ネ	SPRING	
1-1-10	S02562001	1	ハ"ネカケ	SPRING HOOK	
1-1-11	S11618001	1	カッターレハ"	CUTTER LEVER	
1-1-12	014680622	2	アナトメネシ"4.37クホ"ミ	SCREW 4.37	
1-1-13	S11619001	1	ストツハ"アテ	STOPPER PLATE	
1-1-14	018501222	2	アナボ"ルト5X12	BOLT 5X12	
1-1-15	028050242	2	ハ"ネサ"ガ"ネ2-5	SPRING WASHER 2-5	
1-1-16	146354001	2	サ"カ"ネ	WASHER	
1-1-17	S11620001	1	ストツハ"シ"ク	STOPPER SHAFT	
1-1-18	S11621000	1	ストツハ"ゴ"ム	STOPPER RUBBER	
1-1-19	048040342	1	トメフE4	STOP RING E4	
1-1-20	S11622001	1	カッターレハ"ーシ"ク	CUTTER LEVER SHAFT	
1-1-21	S11623001	1	カッターレハ"ーシ"クハ"ネ	SPRING	
1-1-22	140407001	1	サ"カ"ネ	WASHER	
1-1-23	113625001	1	オサエチヨウセツネシ"	PRESSER ADJUSTING SCREW	
1-1-24	S11624000	1	トメネシ"アテ	SCREW PLATE	
1-1-25	014680422	1	アナトメネシ"4.37クホ"ミ	SCREW 4.37	
1-1-26	S11625001	1	シタハ"ト"ダイ	LOWER KNIFE BASE	
1-1-27	018501422	2	アナボ"ルト5X14	BOLT 5X14	
1-1-28	S11626001	1	シタハ	LOWER KNIFE	
1-1-29	003300812	2	サラネシ"3X8	SCREW 3X8	
1-1-30	S11627001	1	シタハチヨウセツネシ"	LOWER KNIFE ADJUSTING SCREW	
1-1-31	S11628001	1	ウフハ	UPPER KNIFE	
1-1-32	061401212	2	サラコ4X12	SCREW 4X12	
1-1-33	S11629001	1	ウフハガ"ート"A	GUARD(A)	
1-1-34	060680712	2	ハ"イント"437-40X7	SCREW 4.37X7	
1-1-35	S11630001	1	ウフハガ"ート"B	GUARD(B)	
1-1-36	S01297001	2	シメネシ"3.57X3.5	SCREW 3.57X3.5	
1-2	018081622	2	アナボ"ルト6X16	BOLT 6X16	
1-3	118064001	1	6カクボ"ウスハ"ナ4	ALLEN WRENCH 4	
10	S11563001	1	クロスフ"レートRクミ	CLOTH PLATE(R)ASSEMBLY	
10-1	S11564001	1	クロスフ"レートR	CLOTH PLATE(R)	
10-2	S08646100	1	マグ"ネット	MAGNET	
10-3	S08639000	1	クロスフ"レートハ"ツキン	CLOTH PLATE PACKING	
10-4	S11568000	1	セイシンシート	SHEET	
11	S11567001	1	クロスフ"レートホシ"ヨイタ	SUB-CLOTH PLATE	
12	S11644001	1	ヌノサエ	CLOTH PRESSER PLATE	
13	S11569001	1	ハリイタササエイタ	NEEDLE PLATE SUPPORTER PLATE	

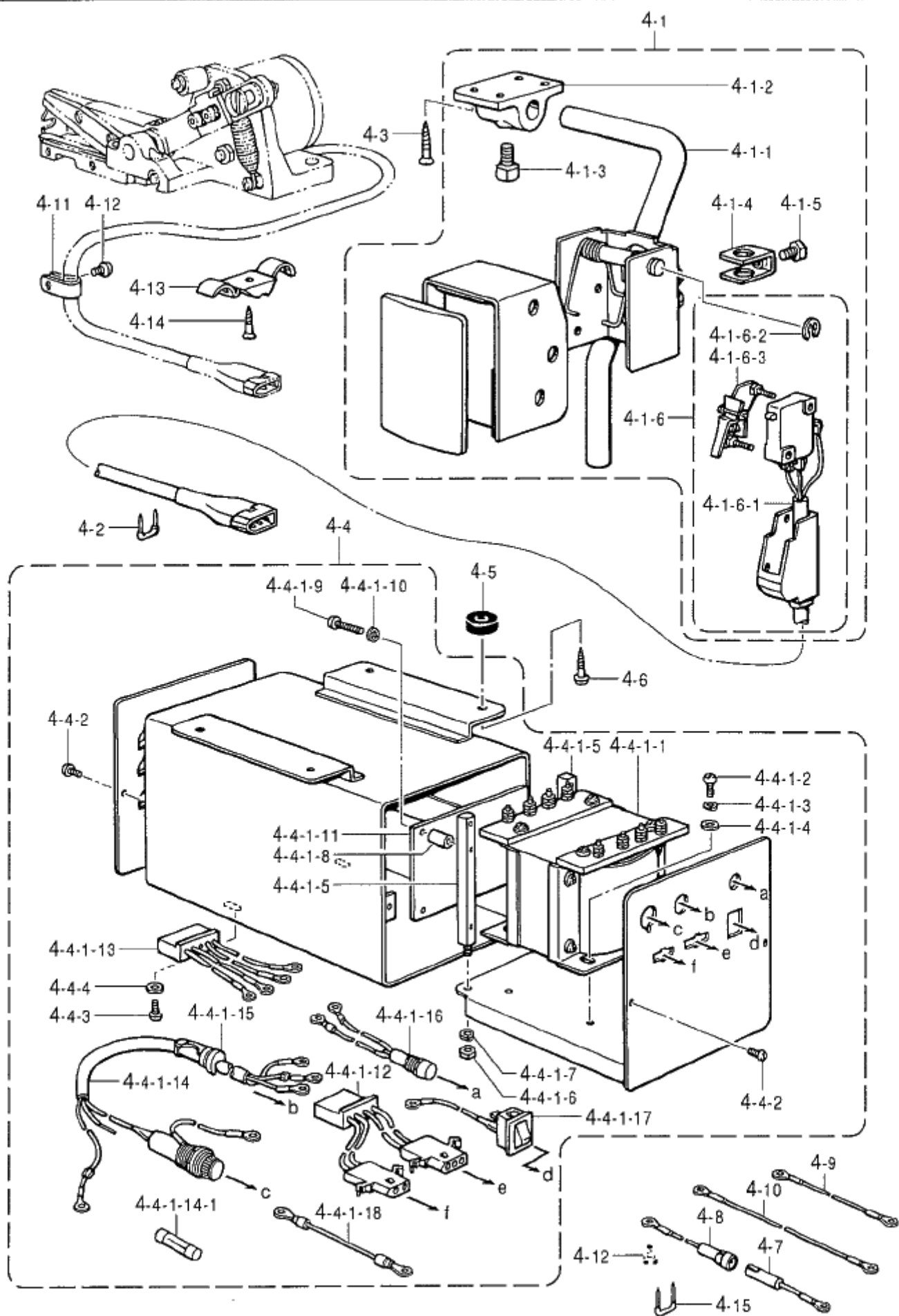

REF.NO.	CODE	Q'TY	品名	NAME OF PARTS	RMKS
4	*	1	T.CコントロールBOXクミ	T.C.CONTROLLER BOX ASSEMBLY	
4-1	147776001	1	ヒサ"スイッチクミ	KNEE SWITCH ASSEMBLY	
4-1-1	147774001	1	ヒサ"スイッチタテシ"ク	KNEE SWITCH SHAFT	
4-1-2	142027001	1	ヒサ"スイッチタテシ"クウケ	KNEE LIFTER SWITCH SHAFT BRACKET	
4-1-3	100463001	1	4カクホ"ルト7.94	BOLT 7.94	
4-1-4	114967001	1	ヒサ"アテストツハ"	STOPPER	
4-1-5	110087001	1	ホ"ルト5.95	BOLT 5.95	
4-1-6	147835001	1	ヒサ"SWケースカハ"ークミ	KNEE SWITCH CASE ASSEMBLY	
4-1-6-1	147826001	1	マイクロスイッチクミ	MICRO SWITCH ASSEMBLY	
4-1-6-2	048060342	2	トメワE6	STOP RING E6	
4-1-6-3	142030000	1	アクチエータ	ACTUATOR	
4-2	200190001	4	ステツフル	STEPL	
4-3	034422503	4	+サラモクネシ"4.1X25	SCREW 4.1X25	
4-4	*	1	コントロールホ"ツクスクミ	CONTROLLER BOX ASSEMBLY	
4-4-1-1	*	1	トランス	TRANSFORMER	
4-4-1-2	062400805	4	ナヘ"コ4X8	SCREW 4X8	
4-4-1-3	028040243	4	ハ"ネサ"ガ"ネ2-4	SPRING WASHER 2-4	
4-4-1-4	025040233	4	ヒラサ"ガ"ネチユウ4	WASHER 4	
4-4-1-5	147808001	2	キハ"ントリツケシ"ク	CIRCUIT SETTING SHAFT	
4-4-1-6	021400164	2	ナツト1シユ4	NUT 4	
4-4-1-7	028040243	2	ハ"ネサ"ガ"ネ2-4	SPRING WASHER 2-4	
4-4-1-8	143498000	4	プ"リントキハ"ンカラー	COLLAR	
4-4-1-9	002302203	4	+ナヘ"ネシ"3X22	SCREW 3X22	
4-4-1-10	028030243	4	ハ"ネサ"ガ"ネ2-3	SPRING WASHER 2-3	
4-4-1-11	S12511000	1	テープ"カッターキハ"ン	TAPE CUTTER CIRCUIT	
4-4-1-12	S12512000	1	ハーネスA	HARNESS(A)	
4-4-1-13	S12513000	1	ハーネスB	HARNESS(B)	
4-4-1-14	S12514000	1	コード"クミ	CORD ASSEMBLY	
4-4-1-14-1	143529000	1	ヒユース"	FUSE	
4-4-1-15	146244000	1	ブ"ツシ"ク"	BUSHING	
4-4-1-16	S12516000	1	ハ"イロツトランプクミ	PILOT LAMP ASSEMBLY	
4-4-1-17	S12663000	1	スイッチクミ	SWITCH ASSEMBLY	
4-4-1-18	*		ジ"ヤンハ"ーセン	JUMPER WIRE	
4-4-2	008400564	4	+トラス4X5	SCREW 4X5	
4-4-3	062400805	2	ナヘ"コ4X8	SCREW 4X8	
4-4-4	025040233	2	ヒラサ"ガ"ネチユウ4	WASHER 4	
4-5	115018001	4	カンシヨウゴム	CUSHION RUBBER	
4-6	031483203	4	マルモクネシ"4.8X32	SCREW 4.8X32	
4-7	S11633000	1	アースセン1	EARTH WIRE(1)	
4-8	S11634000	1	アースセン2	EARTH WIRE(2)	
4-9	S11635000	1	アースセン3	EARTH WIRE(3)	
4-10	S11636000	1	アースセン4	EARTH WIRE(4)	
4-11	149547000	1	コード"オサエ	NYLON CRAMP NK-4N	
4-12	062680712	1	ナヘ"コ437-40X7	SCREW 437X7	
4-13	S10859001	1	クランプ"	CRAMP	
4-14	101795001	1	サラモクネシ"3.5X16	SCREW 3.5X16	
4-15	200190001	3	ステツフル	STEPL	

Sp. 仕様別部品一覧表 / DIFFERENT PARTS LIST

モデル MODEL	サンショウバンゴウ REF. NO.	A-1~B-4	B-4	B-4-4	B-4-4-1-1	B-4-4-1-18		
	ヒンメイ PARTS シヨウ SPEC	T.Cソウチセット デンジ T.CDEVICE COMPLETE SOLENOID	T.Cコントロール BOXクミ T.C CONTROLLER BOX ASSEMBLY	コントロールBOX クミ CONTROLLER BOX ASSEMBLY	トランス TRASFORMER	ジャンパーセン JUMPER WIRE		
TC3	100V	S11642001	S11632001	148356101	147807100	S12517000 (コスト.QTY2)		
TC3	200V	S11642003	S11632003	147802101	147807100	S12517000 (コスト.QTY2)		
TC3	110V	S11642002	S11632002	148358001	148364100	S12517000 (コスト.QTY2)		
TC3	220V	S11642004	S11632004	148360101	148364100	S12517000 (コスト.QTY1)		
TC3	240V	S11642006	S11632006	148362101	148364100	S12517000 (コスト.QTY1)		
TC3	380V	S11642007	S11632007	149012101	149014100	-----		
TC3	400V	S11642008	S11632008	149015101	149014100	-----		
TC3	415V	S11642009	S11632009	S12518101	149014100	-----		

CODE	REF.NO.	PAGE
S01297001	A - 1-1-36	2
S02562001	A - 1-1-10	2
S08639000	A - 10-3	2
S08646100	A - 10-2	2
S10859001	B - 4-13	4
S11563001	A - 10	2
S11564001	A - 10-1	2
S11567001	A - 11	2
S11568000	A - 10-4	2
S11569001	A - 13	2
S11612001	A - 1-1	2
S11613001	A - 1-1-1	2
S11614001	A - 1-1-2	2
S11615001	A - 1-1-3	2
S11616001	A - 1-1-5	2
S11617001	A - 1-1-9	2
S11618001	A - 1-1-11	2
S11619001	A - 1-1-13	2
S11620001	A - 1-1-17	2
S11621000	A - 1-1-18	2
S11622001	A - 1-1-20	2
S11623001	A - 1-1-21	2
S11624000	A - 1-1-24	2
S11625001	A - 1-1-26	2
S11626001	A - 1-1-28	2
S11627001	A - 1-1-30	2
S11628001	A - 1-1-31	2
S11629001	A - 1-1-33	2
S11630001	A - 1-1-35	2
S11631001	A - 1	2
S11632001	B - 4	4
S11632002	B - 4	4
S11632003	B - 4	4
S11632004	B - 4	4
S11632006	B - 4	4
S11632007	B - 4	4
S11632008	B - 4	4
S11632009	B - 4	4
S11633000	B - 4-7	4
S11634000	B - 4-8	4
S11635000	B - 4-9	4
S11636000	B - 4-10	4
S11644001	A - 12	2
S12511000	B - 4-4-1-11	4
S12512000	B - 4-4-1-12	4
S12513000	B - 4-4-1-13	4
S12514000	B - 4-4-1-14	4
S12516000	B - 4-4-1-16	4
S12517000	B - 4-4-1-18	4
S12518101	B - 4-4	4
S12663000	B - 4-4-1-17	4
002302203	B - 4-4-1-9	4
003300812	A - 1-1-29	2
008400564	B - 4-4-2	4
014680422	A - 1-1-25	2
014680622	A - 1-1-12	2
018061622	A - 1-2	2
018501222	A - 1-1-14	2
018501422	A - 1-1-27	2
018771432	A - 1-1-4	2
021400164	B - 4-4-1-6	4
025040233	B - 4-4-1-4	4
	B - 4-4-4	4
028030243	B - 4-4-1-10	4
028040243	B - 4-4-1-3	4
	B - 4-4-1-7	4
028050242	A - 1-1-15	2

CODE	REF.NO.	PAGE
031483203	B - 4-6	4
034422503	B - 4-3	4
048040342	A - 1-1-19	2
048060342	B - 4-1-6-2	4
060680712	A - 1-1-34	2
061401212	A - 1-1-32	2
062400805	B - 4-4-1-2	4
	B - 4-4-3	4
062680712	B - 4-12	4
100463001	B - 4-1-3	4
101795001	B - 4-14	4
110087001	B - 4-1-5	4
113625001	A - 1-1-23	2
114967001	B - 4-1-4	4
115018001	B - 4-5	4
118064001	A - 1-3	2
140407001	A - 1-1-22	2
142027001	B - 4-1-2	4
142030000	B - 4-1-6-3	4
143498000	B - 4-4-1-8	4
143529000	B - 4-4-1-14-1	4
146244000	B - 4-4-1-15	4
146354001	A - 1-1-16	2
147774001	B - 4-1-1	4
147776001	B - 4-1	4
147802101	B - 4-4	4
147807100	B - 4-4-1-1	4
147808001	B - 4-4-1-5	4
147826001	B - 4-1-6-1	4
147835001	B - 4-1-6	4
148356101	B - 4-4	4
148358101	B - 4-4	4
148360101	B - 4-4	4
148362101	B - 4-4	4
148364100	B - 4-4-1-1	4
149012101	B - 4-4	4
149014100	B - 4-4-1-1	4
149015101	B - 4-4	4
149547000	B - 4-11	4
150555001	A - 1-1-7	2
151987001	A - 1-1-8	2
155558001	A - 1-1-6	2
200190001	B - 4-15	4
	B - 4-2	4

3a. ゲージ部品一覧表 / Gauge parts List

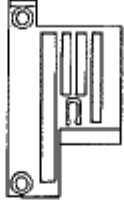
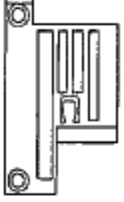
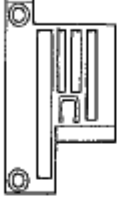
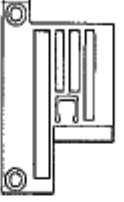
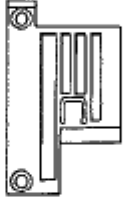
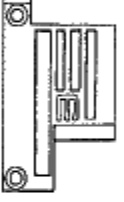
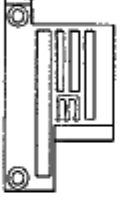
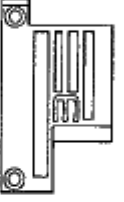
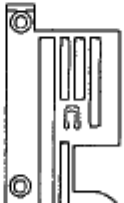
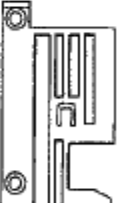
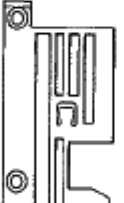
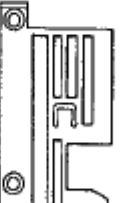
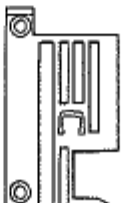
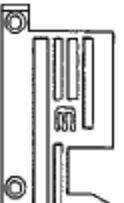
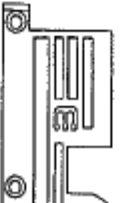
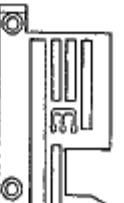
用途 APPLICATION	テープ付用 Tape Attaching			
針数(本) NO. OF NEEDLES	2	2	2	2
針巾 Needle Spacing(MM)	3.2	4.0	4.8	5.6
針板 NEEDLE PLATE	 S11570-001	 S11571-001	 S11572-001	 S11573-001
針数(本) NO. OF NEEDLES	2	3	3	3
針巾 Needle Spacing(MM)	6.4	4.8	5.6	6.4
針板 NEEDLE PLATE	 S11574-001	 S11575-001	 S11576-001	 S11577-001
用途 APPLICATION	レースゴミ付用 (トップメータリ装置付) Elastic Lace Attaching (w/Top Metering Device & Edge Trimming Device)			
針数(本) NO. OF NEEDLES	2	2	2	2
針巾 Needle Spacing(MM)	3.2	4.0	4.8	5.6
針板 NEEDLE PLATE	 S11578-001	 S11579-001	 S11580-001	 S11581-001
針数(本) NO. OF NEEDLES	2	3	3	3
針巾 Needle Spacing(MM)	6.4	4.8	5.6	6.4
針板 NEEDLE PLATE	 S11582-001	 S11583-001	 S11584-001	 S11585-001

brother®

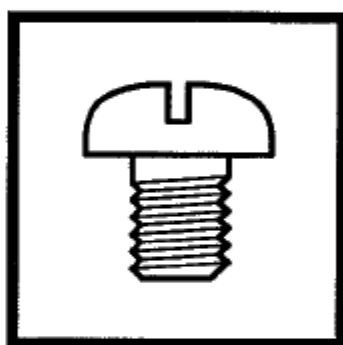

パーツブック
PARTS BOOK

ブラザー工業株式会社

〒467-8561 名古屋市瑞穂区苗代町 15 番 1 号 TEL (052) 824-2392

BROTHER INDUSTRIES, LTD

15-1, Naeshiro-cho, Mizuho-ku, Nagoya 467-8561, Japan. Phone : 81-52-824-2177

Printed in Japan

118-272

195272-121

2002.06.B(1)

www.PromElectroAvtomati.ru