











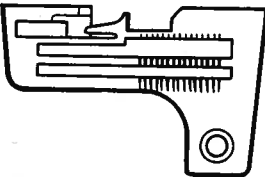

EF4 - B956
EF4 - B957
MA4- B972

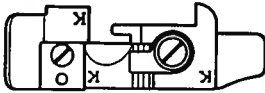
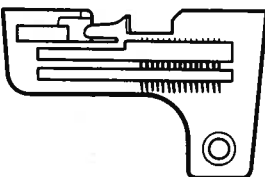

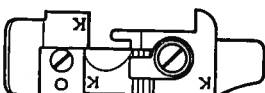
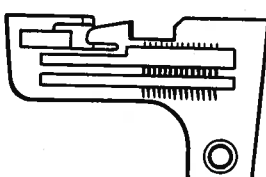

High Speed Overlocker Gauge Parts

I 2080160

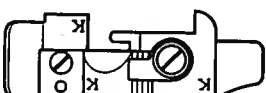

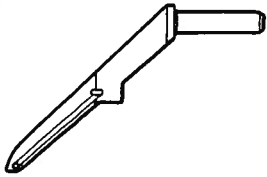
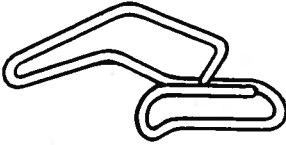
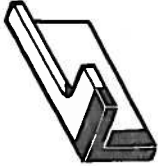
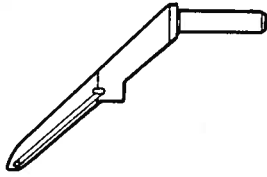
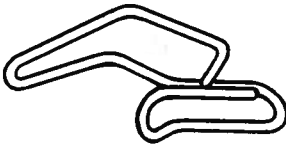

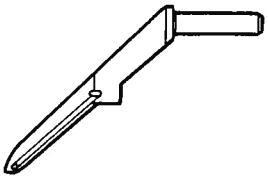

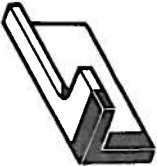



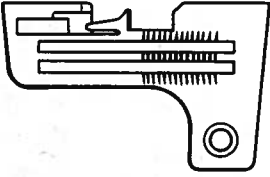

www.PromElectroAvtomat.ru

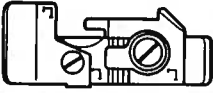
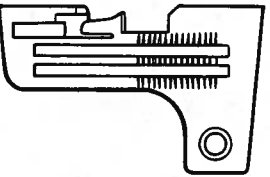

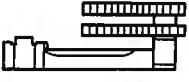

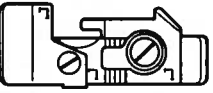
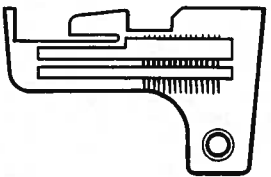
EF4-B956

Sub class	Needle plate	Main feed dog	Differential feed dog	Chain feed dog	Presser foot complete
EF4-B956-01 Overlock width 3mm 3 thread overlock	 140444-0-01	 140450-0-01	 140452-0-01	 142197-0-01	 140460-0-01
EF4-B956-01 Overlock width 4mm 3 thread overlock	 140445-0-01	 140450-0-01	 140452-0-01	 142197-0-01	 140460-0-01
EF4-B956-01 Overlock width 5mm 3 thread overlock	 142346-0-01	 140450-0-01	 140452-0-01	 142197-0-01	 140460-0-01



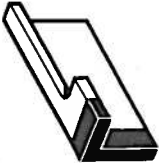
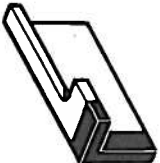

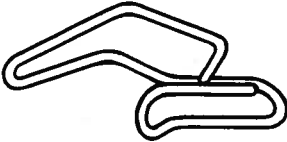

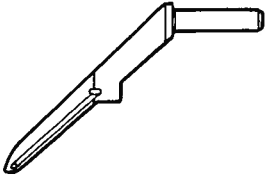
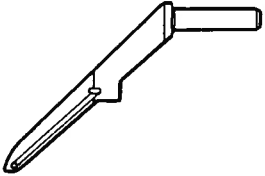
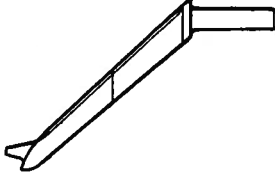

Over looper	Needle thread take-up	Upper knife	Note
 <p>143733-0-01</p>	 <p>142602-0-01</p>	 <p>140242-0-01</p>	<p>(1) Alternation of sub class from -01 to -09, you can change it by only replacing respective gauges.</p>
 <p>143733-0-01</p>	 <p>142602-0-01</p>	 <p>140242-0-01</p>	<p>(2) Alternation of sub class from -01 & -09 to -11, the stitch length is limited upto 3.6mm.</p>
 <p>143733-0-01</p>	 <p>142602-0-01</p>	 <p>140242-0-01</p>	<p>(3) Alternation of sub class from -11 to -01 & -09, the stitch must be limited upto 3.6mm to avoid any breakage, although it can get upto 5.0mm.</p>

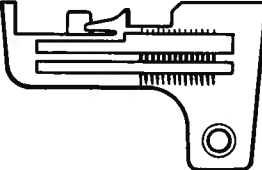



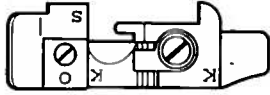
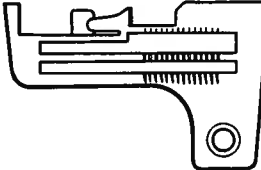
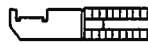

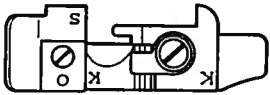
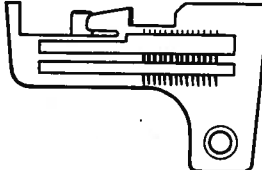
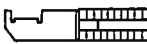
EF4-B956

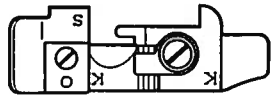
Sub class	Needle plate	Main feed dog	Differential feed dog	Chain feed dog	Presser foot complete
EF4-B956-09 Overlock width 3mm 3 thread overlock	 142191-0-01	 140450-0-01	 142196-0-01	 142197-0-01	 142199-0-01
EF4-B956-09 Overlock width 4mm 3 thread overlock	 142192-0-01	 140450-0-01	 142196-0-01	 142197-0-01	 142199-0-01
EF4-B956-11 Overlock width 5mm thread overlock	 143150-0-01	 140450-0-01	 140453-0-01	 143152-0-01	 143153-0-01



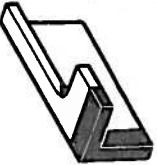

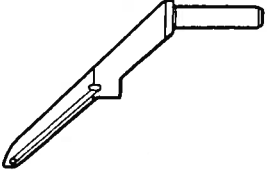
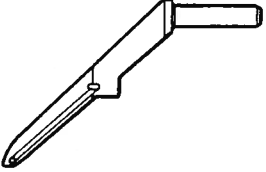
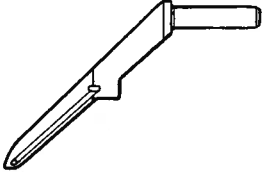

Note			
Upper knife	 <p>142198-0-01</p>	 <p>142198-0-01</p>	 <p>140242-0-01</p>
Needle thread take-up	 <p>142602-0-01</p>	 <p>142602-0-01</p>	 <p>142201-0-01</p>
Over looper	 <p>143733-0-01</p>	 <p>143733-0-01</p>	 <p>143151-0-01</p>

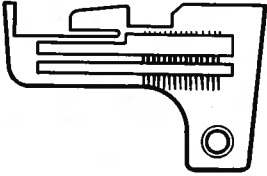

EF4-B956

Sub class	Needle plate	Main feed dog	Differential feed dog	Chain feed dog	Presser foot complete
EF4-B956-101 Overlock width 3mm 3 thread overlock	 143313-0-01	 140450-0-01	 140452-0-01	 142197-0-01	 143364-0-01
EF4-B956-101 Overlock width 4mm 3 thread overlock	 143314-0-01	 140450-0-01	 140452-0-01	 142197-0-01	 143364-0-01
EF4-B956-101 Overlock width 5mm 3 thread overlock	 143318-0-01	 140450-0-01	 140452-0-01	 142197-0-01	 143364-0-01

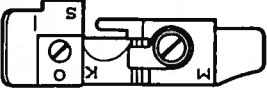
Note			
Upper knife	 140242-0-01	 140242-0-01	 140242-0-01
Needle thread take-up	 142602-0-01	 142602-0-01	 142602-0-01
Over looper	 143733-0-01	 143733-0-01	 143733-0-01

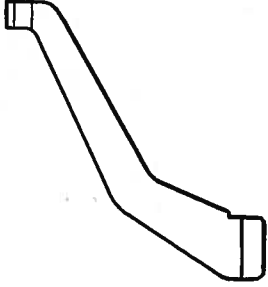
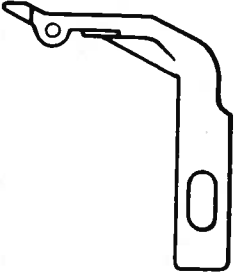

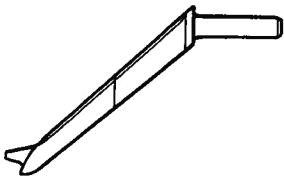

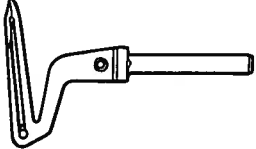
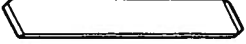



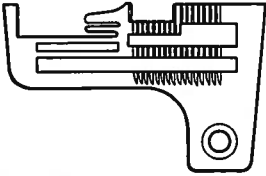

EF4-B956

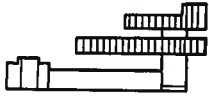
Sub class	Needle plate	Main feed dog	Differential feed dog	Chain feed	Presser foot complete
EF4-B956-111 Overlock width 5mm 2 thread overlock	 143150-0-01	 140451-0-01	 140453-0-01	 143152-0-01	 144544-0-01
Gauges commonly used on all sub-classes	Needle clamp complete  143761-0-01	Needle guard (B)  143753-0-01	Needle guard (F)  143752-0-01		

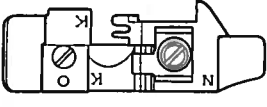
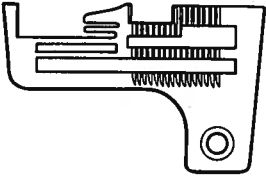
Over looper	Needle thread take - up	Upper knife	Note
<p>143151-0-01</p> 	<p>142201-0-01</p> 	<p>140242-0-01</p> 	
<p>143734-0-01</p> 	<p>118527-0-01</p> 	<p>Under looper</p> <p>Lower knife</p>	

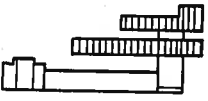
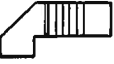
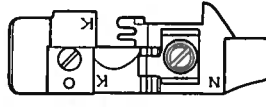
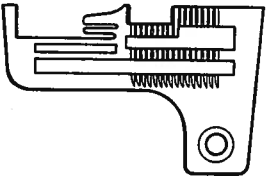

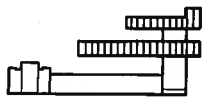

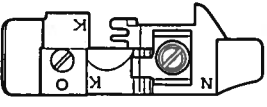

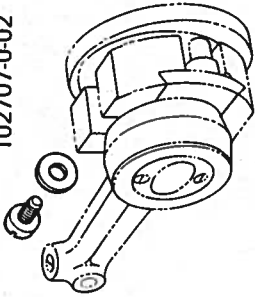
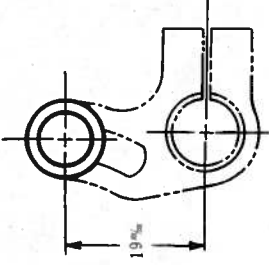
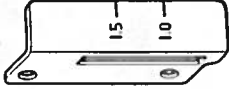
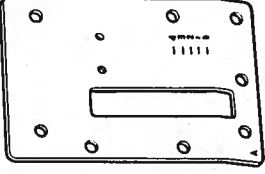
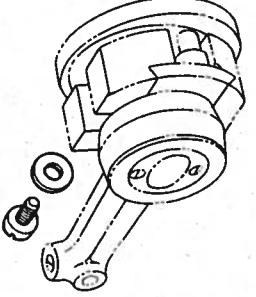
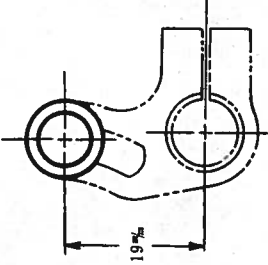
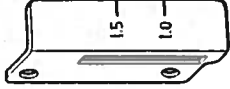
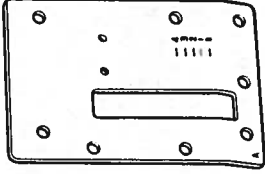
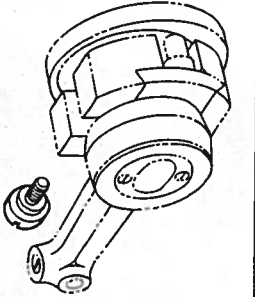
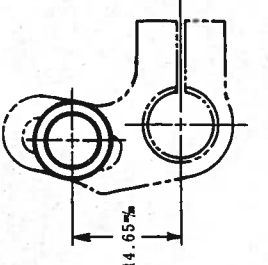
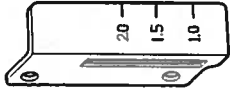
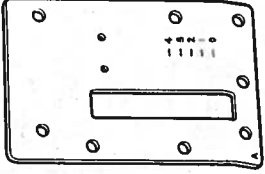

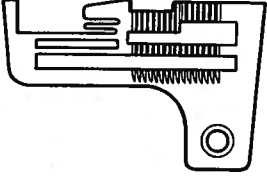

www.PromElectroAvtomat.ru

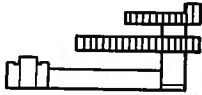

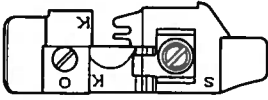
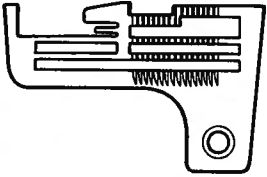
EF4-B957



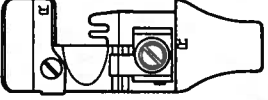
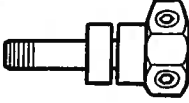
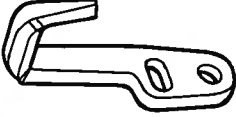
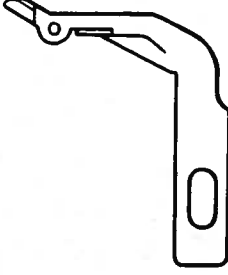

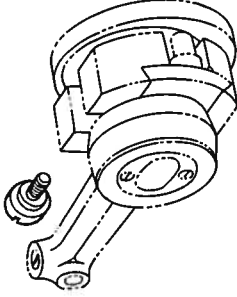
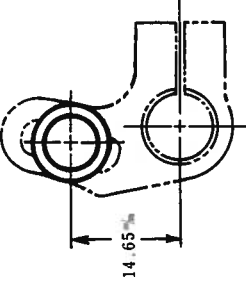
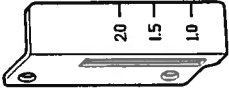
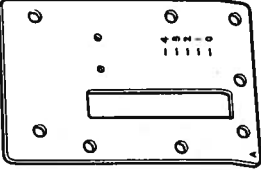
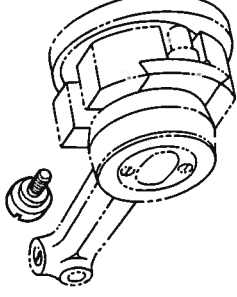
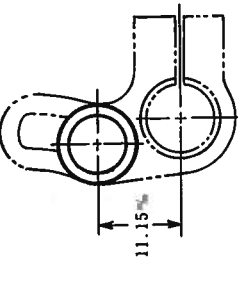
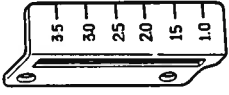
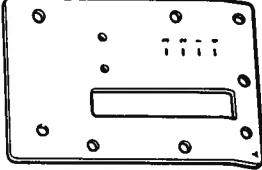
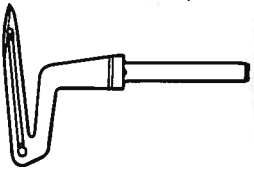

Sub class	Needle plate	Main feed dog	Differential feed dog	Chain feed dog	Presser foot complete
EF4-B957-1 Needle gauge 2.2mm Overlock width 5mm 4 thread overlock	 144020-0-01	 144064-0-01	 144067-0-01	 144070-0-01	 144089-0-01
EF4-B957-2 Needle gauge 2.2mm Overlock width 6mm 4 thread overlock (Mock safety)	 144021-0-01	 144064-0-01	 144067-0-01	 144070-0-01	 144089-0-01
EF4-B957-3 Needle gauge 2.2mm Overlock width 5mm 4 thread overlock	 144020-0-01	 144062-0-01	 144065-0-01	 144070-0-01	 144089-0-01

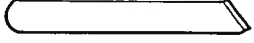
Eccentric adjusting screw	Main feed shaft set position	Differential stitch control	Face plate	
<p>105123-0-03 102707-0-02</p> 	 <p>19mm</p>	 <p>15 1.0</p> <p>144096-0-01</p>	 <p>144613-0-01</p>	
<p>105123-0-03 102707-0-02</p> 	 <p>19mm</p>	 <p>15 1.0</p> <p>144096-0-01</p>	 <p>144613-0-01</p>	
<p>144058-0-01</p> 	 <p>14.65mm</p>	 <p>20 15 1.0</p> <p>144095-0-01</p>	 <p>144612-0-01</p>	

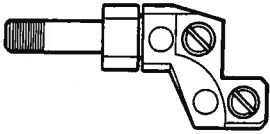
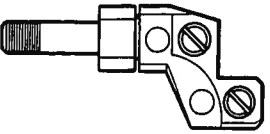
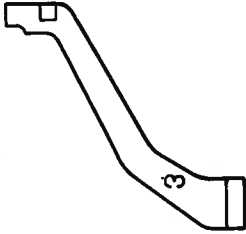
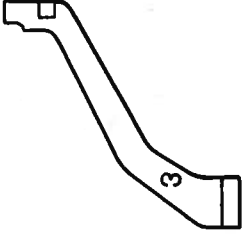

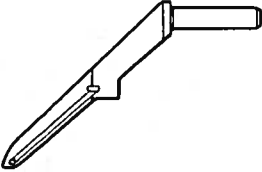
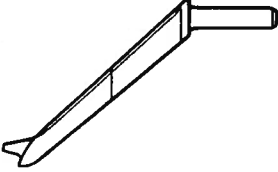
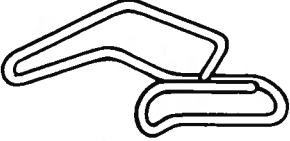
EF4-B957







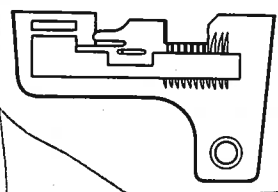
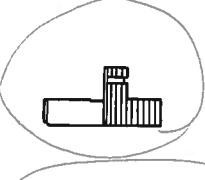
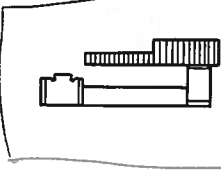
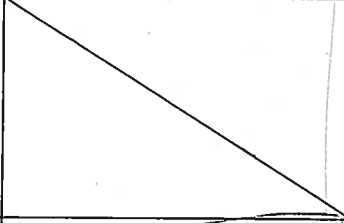
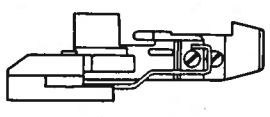
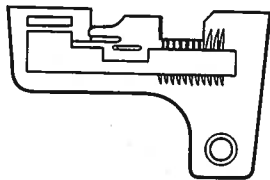

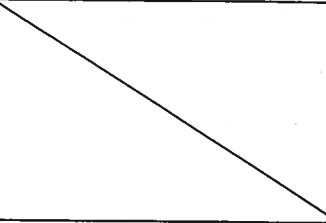
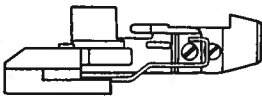
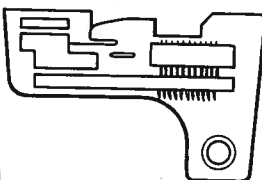
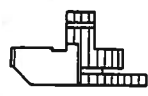
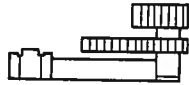
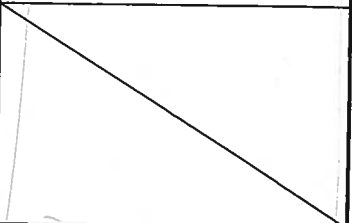
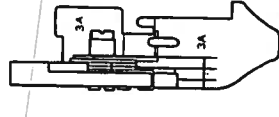
Sub class	Needle plate	Main feed dog	Differential feed dog	Chain feed dog	Presser foot complete
EF4-B957-4 Needle gauge 2.2mm Overlock width 7mm 4 thread overlock (Mock safety)	 144024-0-01	 144062-0-01	 144065-0-01	 144070-0-01	 144101-0-01
	 144022-0-01	 144063-0-01	 144066-0-01	 144069-0-01	 144097-0-01
Gauges commonly used on all sub-classes	Needle clamp complete  144017-0-01	Movable needle guard  144127-0-01	Needle guard(B)  144126-0-01	Over looper  144042-0-01	

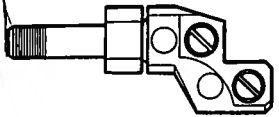
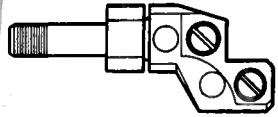
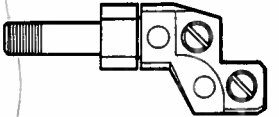
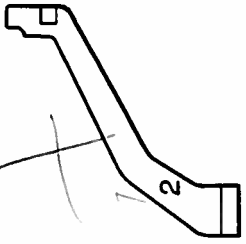
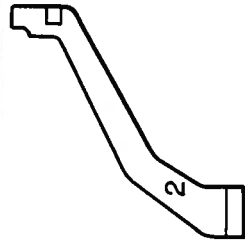
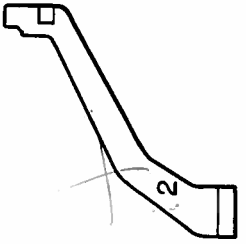
Eccentric adjusting screw	Main feed shaft set position	Differential ratio plate	Face plate	
<p>144058-0-01</p> 	 <p>14.65 mm</p>	 <p>144095-0-01</p>	 <p>144612-0-01</p>	
<p>144058-0-01</p> 	 <p>11.15 mm</p>	 <p>144094-0-01</p>	 <p>143995-0-01</p>	
<p>Under looper</p>  <p>144049-0-01</p>	<p>Upper knife</p>  <p>144074-0-01</p>	<p>Lower knife</p>  <p>144077-0-01</p>		

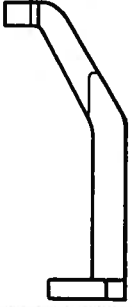

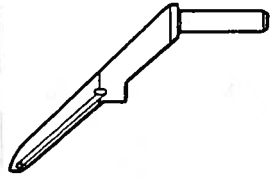
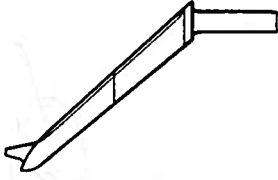
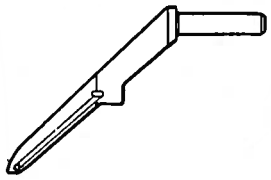

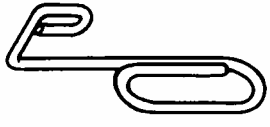

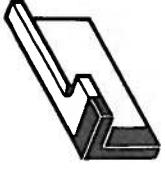
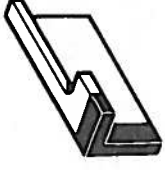
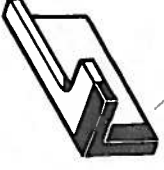
Needle clamp complete		142126-0-01		142126-0-01
Needle guard (overlock stitch)		140108-0-03		140108-0-03
Needle guard (chain stitch)		140997-0-01		140997-0-01
Over looper		143733-0-01		143151-0-01
Needle thread take-up		142602-0-01		142201-0-01
Upper knife		140242-0-01		140242-0-01



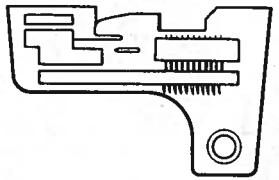

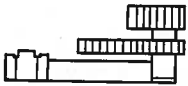
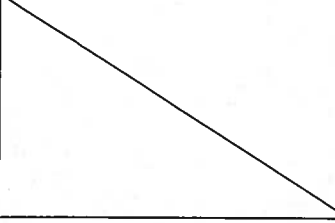
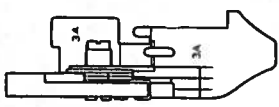
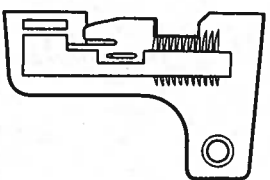

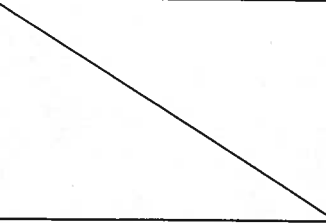
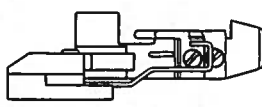
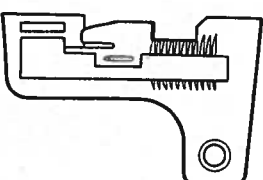
MA4-B972

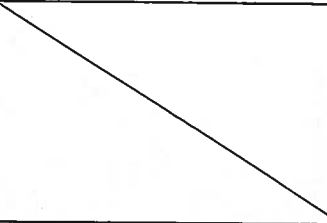
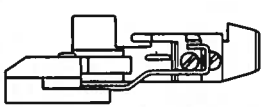
Sub class	Needle plate	Main feed dog	Differential feed dog	Chain feed dog	Presser foot complete
MA4-B972-2 A Needle gauge 2mm Overlock width 3mm 5 thread safety stitch	 142249-0-01	 142370-0-01	 142371-0-01		 142250-0-01
MA4-B972-2 B Needle gauge 2mm Overlock width 3mm 4 thread safety stitch	 142249-0-01	 142370-0-01	 142371-0-01		 142250-0-01
MA4-B972-3 A Needle gauge 3mm Overlock width 5mm 5 thread safety stitch	 143296-0-01	 143297-0-01	 140194-0-01		 140268-0-01

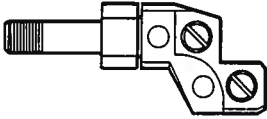
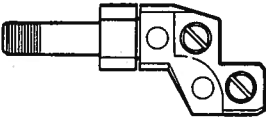
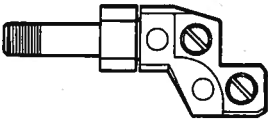
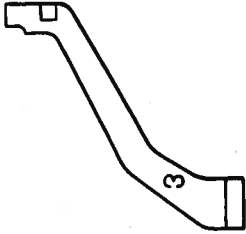
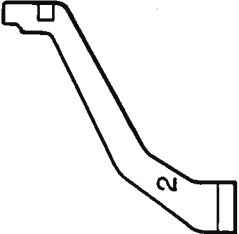
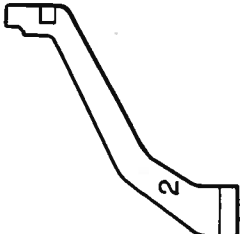
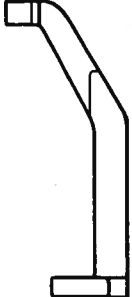

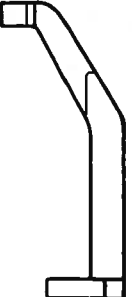
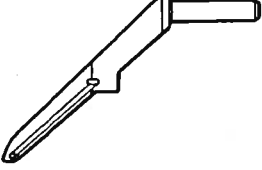
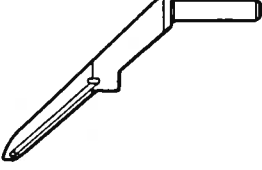
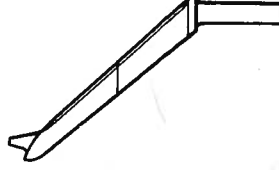
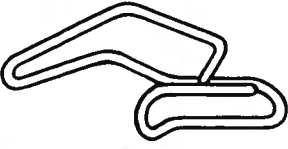
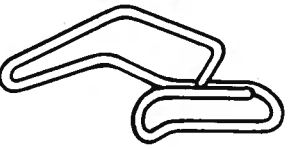

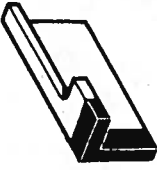

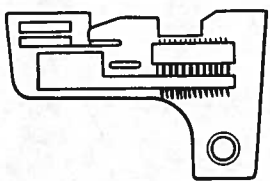

Needle clamp complete	 142127-0-01	 142127-0-01	 140736-0-01
Needle guard (overlock stitch)	 140108-0-02	 140108-0-02	 140108-0-02
Needle guard (chain stitch)	 140912-0-01	 140912-0-01	 140912-0-01
Over looper	 143733-0-01	 143151-0-01	 143733-0-01
Needle thread take - up	 142602-0-01	 142201-0-01	 142602-0-01
Upper knife	 142198-0-01	 142198-0-01	 140242-0-01

MA4-B972

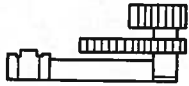
Sub class	Needle plate	Main feed dog	Differential feed dog	Chain feed dog	Presser foot complete
MA4-B972-3 A Needle gauge 3mm Overlock width 5mm 5 thread safety stitch	 143296-0-01	 143297-0-01	 140194-0-01		 140268-0-01
MA4-B972-3 A Needle gauge 3mm Overlock width 5mm 5 thread safety stitch	 142237-0-01	 142238-0-01	 142239-0-01		 142240-0-01
MA4-B972-3 B Needle gauge 3mm Overlock width 5mm 4 thread safety stitch	 142237-0-01	 142238-0-01	 142239-0-01		 142240-0-01

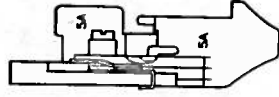
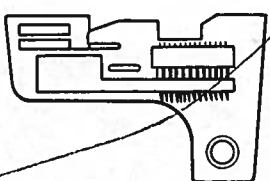
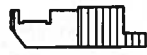
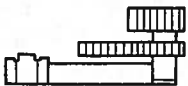
Needle clamp complete	 140736-0-01	 140736-0-01	 140736-0-01
Needle guard (overlock stitch)	 140108-0-03	 140108-0-02	 140108-0-02
Needle guard (chain stitch)	 140912-0-01	 140912-0-01	 140912-0-01
Over looper	 143733-0-01	 143733-0-01	 143151-0-01
Needle thread take-up	 142602-0-01	 142602-0-01	 142201-0-01
Upper knife	 140242-0-01	 142198-0-01	 142198-0-01

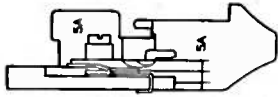
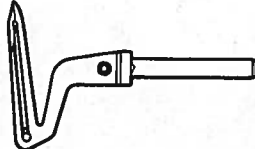
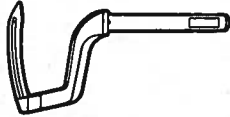
MA4-B972

Sub class	Needle plate	Main feed dog	Differential feed dog	Chain feed dog	Presser foot complete
MA4-B972-5A Needle gauge 5mm Overlock width 5mm 5 thread safety stitch	 140985-0-01	 142129-0-01	 140195-0-01	 140989-0-01	 140989-0-01
MA4-B972-5B Needle gauge 5mm Overlock width 5mm 4 thread safety	 140985-0-01	 142129-0-01'	 140195-0-01	 140989-0-01	 140989-0-01
Gauges commonly used on all sub-chasses	Under looper  143734-0-01	Chain stitch looper  140161-0-01	Lower knife  118527-0-01		